

ASROCK
Z87 EXTREME6/ac
Z87 EXTREME6

User Manual



Version 1.0

Published May 2013

Copyright©2013 ASRock INC. All rights reserved.

Copyright Notice:

No part of this documentation may be reproduced, transcribed, transmitted, or translated in any language, in any form or by any means, except duplication of documentation by the purchaser for backup purpose, without written consent of ASRock Inc.

Products and corporate names appearing in this documentation may or may not be registered trademarks or copyrights of their respective companies, and are used only for identification or explanation and to the owners' benefit, without intent to infringe.

Disclaimer:

Specifications and information contained in this documentation are furnished for informational use only and subject to change without notice, and should not be constructed as a commitment by ASRock. ASRock assumes no responsibility for any errors or omissions that may appear in this documentation.

With respect to the contents of this documentation, ASRock does not provide warranty of any kind, either expressed or implied, including but not limited to the implied warranties or conditions of merchantability or fitness for a particular purpose.

In no event shall ASRock, its directors, officers, employees, or agents be liable for any indirect, special, incidental, or consequential damages (including damages for loss of profits, loss of business, loss of data, interruption of business and the like), even if ASRock has been advised of the possibility of such damages arising from any defect or error in the documentation or product.



This device complies with Part 15 of the FCC Rules. Operation is subject to the following two conditions:

- (1) this device may not cause harmful interference, and
- (2) this device must accept any interference received, including interference that may cause undesired operation.

CALIFORNIA, USA ONLY

The Lithium battery adopted on this motherboard contains Perchlorate, a toxic substance controlled in Perchlorate Best Management Practices (BMP) regulations passed by the California Legislature. When you discard the Lithium battery in California, USA, please follow the related regulations in advance.

“Perchlorate Material-special handling may apply, see www.dtsc.ca.gov/hazardouswaste/perchlorate”

ASRock Website: <http://www.asrock.com>

The terms HDMI™ and HDMI High-Definition Multimedia Interface, and the HDMI logo are trademarks or registered trademarks of HDMI Licensing LLC in the United States and other countries.



Manufactured under license under U.S. Patent Nos: 5,956,674; 5,974,380; 6,487,535; 7,003,467 & other U.S. and worldwide patents issued & pending. DTS, the Symbol, & DTS and the Symbol together is a registered trademark & DTS Connect, DTS Interactive, DTS Neo:PC are trademarks of DTS, Inc. Product includes software.

© DTS, Inc., All Rights Reserved.



Contents

| | |
|---|-----------|
| Chapter 1 Introduction | 1 |
| 1.1 Package Contents | 1 |
| 1.2 Specifications | 2 |
| 1.3 Unique Features | 7 |
| 1.4 Motherboard Layout | 11 |
| 1.5 I/O Panel | 14 |
| 1.6 WiFi-802.11n Module and ASRock WiFi 2.4GHz Antenna (for Z87 Extreme6/ac only) | 16 |
| Chapter 2 Installation | 19 |
| 2.1 Installing the CPU | 20 |
| 2.2 Installing the CPU Fan and Heatsink | 23 |
| 2.3 Installing Memory Modules (DIMM) | 24 |
| 2.4 Expansion Slots (PCI and PCI Express Slots) | 26 |
| 2.5 Jumpers Setup | 27 |
| 2.6 Onboard Headers and Connectors | 28 |
| 2.7 Smart Switches | 33 |
| 2.8 Dr. Debug | 34 |
| 2.9 Front USB 3.0 Panel Installation Guide | 36 |
| 2.10 Rear USB 3.0 Bracket Installation Guide | 38 |
| 2.11 Using the HDMI-In Port | 39 |
| 2.12 SLI™ and Quad SLI™ Operation Guide | 42 |
| 2.12.1 Installing Two SLI™-Ready Graphics Cards | 42 |
| 2.12.2 Driver Installation and Setup | 44 |

| | | |
|---|---|-----------|
| 2.13 | CrossFireX™, 3-Way CrossFireX™ and Quad CrossFireX™ Operation Guide | 45 |
| 2.13.1 | Installing Two CrossFireX™-Ready Graphics Cards | 45 |
| 2.13.2 | Installing Three CrossFireX™-Ready Graphics Cards | 46 |
| 2.13.3 | Driver Installation and Setup | 47 |
| 2.14 | Dual LAN and Teaming Operation Guide | 48 |
| Chapter 3 Software and Utilities Operation | | 49 |
| 3.1 | Installing Drivers | 49 |
| 3.2 | A-Tuning | 50 |
| 3.3 | Intel® Rapid Start Technology | 54 |
| 3.4 | Intel® Smart Connect Technology | 59 |
| 3.5 | Intel® Remote Wake Technology | 64 |
| 3.5.1 | Configuring and Using MeshCentral | 64 |
| 3.5.2 | Configuring and Using Splashtop | 69 |
| 3.6 | Start8 | 72 |
| Chapter 4 UEFI SETUP UTILITY | | 75 |
| 4.1 | Introduction | 75 |
| 4.1.1 | UEFI Menu Bar | 75 |
| 4.1.2 | Navigation Keys | 76 |
| 4.2 | Main Screen | 77 |
| 4.3 | OC Tweaker Screen | 78 |
| 4.4 | Advanced Screen | 87 |
| 4.4.1 | CPU Configuration | 88 |
| 4.4.2 | Chipset Configuration | 90 |

| | | |
|-------|---|-----|
| 4.4.3 | Storage Configuration | 92 |
| 4.4.4 | Intel® Rapid Start Technology | 94 |
| 4.4.5 | Intel® Smart Connect Technology | 95 |
| 4.4.6 | Super IO Configuration | 96 |
| 4.4.7 | ACPI Configuration | 97 |
| 4.4.8 | USB Configuration | 99 |
| 4.5 | Tools | 100 |
| 4.6 | Hardware Health Event Monitoring Screen | 103 |
| 4.7 | Boot Screen | 104 |
| 4.8 | Security Screen | 107 |
| 4.9 | Exit Screen | 108 |

Chapter 1 Introduction

Thank you for purchasing ASRock Z87 Extreme6/ac / Z87 Extreme6 motherboard, a reliable motherboard produced under ASRock's consistently stringent quality control. It delivers excellent performance with robust design conforming to ASRock's commitment to quality and endurance.

In this documentation, Chapter 1 and 2 contains the introduction of the motherboard and step-by-step installation guides. Chapter 3 contains the operation guide of the software and utilities. Chapter 4 contains the configuration guide of the BIOS setup.



Because the motherboard specifications and the BIOS software might be updated, the content of this documentation will be subject to change without notice. In case any modifications of this documentation occur, the updated version will be available on ASRock's website without further notice. If you require technical support related to this motherboard, please visit our website for specific information about the model you are using. You may find the latest VGA cards and CPU support list on ASRock's website as well. ASRock website <http://www.asrock.com>.

1.1 Package Contents

- ASRock Z87 Extreme6/ac / Z87 Extreme6 Motherboard (ATX Form Factor)
- ASRock Z87 Extreme6/ac / Z87 Extreme6 Quick Installation Guide
- ASRock Z87 Extreme6/ac / Z87 Extreme6 Support CD
- 6 x Serial ATA (SATA) Data Cables (Optional)
- 1 x I/O Panel Shield
- 1 x ASRock SLI_Bridge_2S Card
- 1 x Front USB 3.0 Panel with 2.5" HDD/SSD Rack
- 4 x HDD Screws
- 6 x Chassis Screws
- 1 x Rear USB 3.0 Bracket
- 1 x ASRock WiFi 2.4/5GHz Antenna (for Z87 Extreme6/ac only)
- 2 x SMA Wi-Fi Antenna Cables (for Z87 Extreme6/ac only)
- 1 x WiFi Module Screw (for Z87 Extreme6 only)

1.2 Specifications

- Platform**
- ATX Form Factor
 - Premium Gold Capacitor design (100% Japan-made high-quality Conductive Polymer Capacitors)

- A-Style**
- Home Cloud
 - 802.11ac WiFi (for Z87 Extreme6/ac only)
 - Purity Sound™
 - HDMI-In

- CPU**
- Socket LGA1150 to support 4th Gen Intel® Core™ Processor
 - Digi Power Design
 - 12 Power Phase Design
 - Dual-Stack MOSFET (DSM)
 - Supports Intel® Turbo Boost 2.0 Technology
 - Supports Intel® K-Series unlocked CPU Supports ASRock BCLK Full-range Overclocking

- Chipset**
- Intel® Z87

- Memory**
- Dual Channel DDR3 Memory Technology
 - 4 x DDR3 DIMM slots
 - Supports DDR3 2933+(OC)/2800(OC)/2400(OC)/2133(OC)/1866(OC)/1600/1333/1066 non-ECC, un-buffered memory
 - Max. capacity of system memory: 32GB (see CAUTION)
 - Supports Intel® Extreme Memory Profile (XMP)1.3/1.2
 - Distortion-Free Slot

- Expansion Slot**
- 3 x PCI Express 3.0 x16 slots (PCIE2/PCIE3/PCIE4: single at x16 (PCIE2); dual at x8 (PCIE2) / x8 (PCIE3); triple at x8 (PCIE2) / x4 (PCIE3) / x4 (PCIE4))
 - 1 x PCI Express 2.0 x1 slot
 - 2 x PCI slots
 - 1 x mini-PCI Express slot
 - Supports AMD Quad CrossFireX™, 3-Way CrossFireX™ and CrossFireX™
 - Supports NVIDIA® Quad SLI™ and SLI™

Graphics

- Intel® HD Graphics Built-in Visuals and the VGA outputs can be supported only with processors which are GPU integrated.
- Supports Intel® HD Graphics Built-in Visuals : Intel® Quick Sync Video with AVC, MVC (S3D) and MPEG-2 Full HW Encode1, Intel® InTru™ 3D, Intel® Clear Video HD Technology, Intel® Insider™, Intel® HD Graphics 4400/4600
- Pixel Shader 5.0, DirectX 11.1
- Max. shared memory 1792MB
- Three VGA Output options: DVI-I, HDMI and DisplayPort
- Supports Triple Monitors
- Supports HDMI Technology with max. resolution up to 4K × 2K (4096x2304) @ 24Hz
- Supports DVI-I with max. resolution up to 1920x1200 @ 60Hz
- Supports DisplayPort with max. resolution up to 4K × 2K (4096x2304) @ 24Hz
- Supports Auto Lip Sync, Deep Color (12bpc), xvYCC and HBR (High Bit Rate Audio) with HDMI (Compliant HDMI monitor is required)
- Supports HDCP function with DVI-I, HDMI and DisplayPort ports
- Supports Full HD 1080p Blu-ray (BD) / HD-DVD playback with DVI-I, HDMI and DisplayPort ports

Audio

- 7.1 CH HD Audio with Content Protection (Realtek ALC1150 Audio Codec)
- Premium Blu-ray audio support
- Supports Purity Sound™
 - 115dB SNR DAC with differential amplifier
 - TI® NE5532 Premium Headset Amplifier (supports up to 600 Ohms headsets)
 - Direct Drive Technology
 - EMI shielding cover
 - PCB isolate shielding
- Supports DTS Connect

LAN

- Gigabit LAN 10/100/1000 Mb/s
- 1 x Giga PHY Intel® I217V, 1 x GigaLAN Intel® I211AT
- Supports Intel® Remote Wake Technology (on Intel® I217V)
- Supports Wake-On-LAN
- Supports Dual LAN with Teaming
- Supports Energy Efficient Ethernet 802.3az
- Supports PXE

**Wireless
LAN
(for Z87
Extreme6/
ac only)**

- Supports IEEE 802.11a/b/g/n/ac
- Supports Dual-Band (2.4/5 GHz)
- Supports High speed wireless connection up to 867Mbps
- 2 antennas to support 2 (Transmit) x 2 (Receive) diversity technology
- Supports Bluetooth 4.0 / 3.0 + High speed class II

**Rear Panel
I/O**

- 1 x PS/2 Mouse/Keyboard Port
- 1 x DVI-I Port
- 1 x HDMI-Out Port
- 1 x HDMI-In Port
- 1 x DisplayPort
- 1 x Optical SPDIF Out Port
- 1 x eSATA Connector
- 2 x USB 2.0 Ports
- 4 x USB 3.0 Ports (ASMedia Hub)
- 2 x RJ-45 LAN Ports with LED (ACT/LINK LED and SPEED LED)
- 1 x Clear CMOS Switch
- HD Audio Jack: Rear Speaker / Central / Bass / Line in / Front Speaker / Microphone

Storage

- 6 x SATA3 6.0 Gb/s connectors by Intel® Z87, support RAID (RAID 0, RAID 1, RAID 5, RAID 10, Intel Rapid Storage Technology 12 and Intel Smart Response Technology), NCQ, AHCI and “Hot Plug”
- 4 x SATA3 6.0 Gb/s connectors by ASMedia ASM1061, support NCQ, AHCI and “Hot Plug” functions (SATA3_A4 connector is shared with the eSATA port)
- 1 x eSATA connector by ASMedia ASM1061, supports NCQ, AHCI, “Hot Plug” and Port Multiplier functions

Connector

- 1 x IR header
- 1 x COM port header
- 1 x Power LED header
- 2 x CPU Fan connectors (1 x 4-pin, 1 x 3-pin)
- 3 x Chassis Fan connectors (1 x 4-pin, 2 x 3-pin)
- 1 x Power Fan connector (3-pin)
- 1 x 24 pin ATX power connector
- 1 x 8 pin 12V power connector (Hi-Density Power Connector)
- 1 x SLI/XFire power connector
- 1 x Front panel audio connector
- 2 x USB 2.0 headers (support 4 USB 2.0 ports)
- 1 x Vertical Type A USB 2.0
- 2 x USB 3.0 headers (support 4 USB 3.0 ports)
- 1 x Dr. Debug with LED
- 1 x Power Switch with LED
- 1 x Reset Switch with LED

BIOS Feature

- 2 x 64Mb AMI UEFI Legal BIOS with Multilingual GUI support (1 x Main BIOS and 1 x Backup BIOS)
- Supports Secure Backup UEFI Technology
- ACPI 1.1 Compliance Wake Up Events
- SMBIOS 2.3.1 Support
- CPU, DRAM, PCH 1.05V, PCH 1.5V Voltage Multi-adjustment

Support CD

- Drivers, Utilities, AntiVirus Software (Trial Version), Cyber-Link MediaEspresso 6.5 Trial, Google Chrome Browser and Toolbar, Start8, MeshCentral, Splashtop Streamer,

Hardware

- CPU/Chassis Temperature Sensing
- CPU/Chassis/Power Fan Tachometer
- CPU/Chassis Quiet Fan (Allow Chassis Fan Speed Auto-Adjust by CPU Temperature)
- CPU/Chassis Fan Multi-Speed Control
- Voltage Monitoring: +12V, +5V, +3.3V, CPU Vcore

OS

- Microsoft® Windows® 8 / 8 64-bit / 7 / 7 64-bit compliant

Certifications

- FCC, CE, WHQL
- ErP/EuP Ready (ErP/EuP ready power supply is required)

* For detailed product information, please visit our website: <http://www.asrock.com>



Please realize that there is a certain risk involved with overclocking, including adjusting the setting in the BIOS, applying Untied Overclocking Technology, or using third-party overclocking tools. Overclocking may affect your system's stability, or even cause damage to the components and devices of your system. It should be done at your own risk and expense. We are not responsible for possible damage caused by overclocking.



Due to limitation, the actual memory size may be less than 4GB for the reservation for system usage under Windows® 32-bit operating systems. Windows® 64-bit operating systems do not have such limitations. You can use ASRock XFast RAM to utilize the memory that Windows® cannot use.

1.3 Unique Features



ASRock A-Tuning

A-Tuning is ASRock's multi purpose software suite with a new interface, more new features and improved utilities, including XFast RAM, Dehumidifier, Good Night LED, FAN-Tastic Tuning, OC Tweaker and a whole lot more.



ASRock Instant Flash

ASRock Instant Flash is a BIOS flash utility embedded in Flash ROM. This convenient BIOS update tool allows you to update the system BIOS in a few clicks without preparing an additional floppy diskette or other complicated flash utility. Just save the new BIOS file to your USB storage and launch this tool by pressing <F6> or <F2> during POST to enter the BIOS setup menu to access ASRock Instant Flash. Please be noted that the USB flash drive or hard drive must use FAT32/16/12 file system.



ASRock APP Charger

Simply by installing the ASRock APP Charger makes your iPhone/iPad/iPod Touch charge up to 40% faster than before on your computer. ASRock APP Charger allows you to quickly charge many Apple devices simultaneously and even supports continuous charging when your PC enters into Standby mode (S1), Suspend to RAM (S3), hibernation mode (S4) or power off (S5).



ASRock XFast USB

ASRock XFast USB can boost the performance of your USB storage devices. The performance may depend on the properties of the device.



ASRock XFast LAN

ASRock XFast LAN provides faster internet access, which includes the benefits listed below. LAN Application Prioritization: You can configure your application's priority ideally and add new programs to the list. Lower Latency in Game: After setting online game's priority higher, it can lower the latency in games. Traffic Shaping: You can watch Youtube HD videos and download simultaneously. Real-Time Analysis of Your Data: With the status window, you can easily recognize which data streams you are currently transferring.



ASRock XFast RAM

ASRock XFast RAM is included in A-Tuning. It fully utilizes the memory space that cannot be used under Windows® 32-bit operating systems. ASRock XFast RAM shortens the loading time of previously visited websites, making web surfing faster than ever. And it also boosts the speed of Adobe Photoshop 5 times faster. Another advantage of ASRock XFast RAM is that it reduces the frequency of accessing your SSDs or HDDs in order to extend their lifespan.



ASRock Crashless BIOS

ASRock Crashless BIOS allows users to update their BIOS without fear of failing. If power loss occurs during the BIOS updating process, ASRock Crashless BIOS will automatically finish the BIOS update procedure after regaining power. Please note that BIOS files need to be placed in the root directory of your USB disk. Only USB 2.0 ports support this feature.



ASRock OMG (Online Management Guard)

Administrators are able to establish an internet curfew or restrict internet access at specified times via OMG. You may schedule the starting and ending hours of internet access granted to other users. In order to prevent users from bypassing OMG, guest accounts without permission to modify the system time are required.



ASRock Internet Flash

ASRock Internet Flash downloads and updates the latest UEFI firmware version from our servers for you without entering Windows® OS. Please setup network configuration before using Internet Flash.



ASRock UEFI System Browser

ASRock System Browser shows the overview of your current PC and the devices connected.



ASRock Dehumidifier Function

Users may prevent motherboard damages due to dampness by enabling “Dehumidifier Function”. When enabling Dehumidifier Function, the computer will power on automatically to dehumidify the system after entering S4/S5 state.



ASRock Easy RAID Installer

ASRock Easy RAID Installer can help you to copy the RAID driver from the support CD to your USB storage device. After copying the RAID driver to your USB storage device, please change “SATA Mode” to “RAID”, then you can start installing the OS in RAID mode.



ASRock Easy Driver Installer

For users that don't have an optical disk drive to install the drivers from our support CD, Easy Driver Installer is a handy tool in the UEFI that installs the LAN driver to your system via an USB storage device, then downloads and installs the other required drivers automatically.



ASRock Interactive UEFI

ASRock Interactive UEFI is a blend of system configuration tools, cool sound effects and stunning visuals. The unprecedented UEFI provides a more attractive interface and more amusement.



ASRock Fast Boot

With ASRock's exclusive Fast Boot technology, it takes less than 1.5 seconds to logon to Windows 8 from a cold boot. No more waiting! The speedy boot will completely change your user experience and behavior.



ASRock Restart to UEFI

Windows® 8 brings the ultimate boot up experience. The lightning boot up speed makes it hard to access the UEFI setup. ASRock Restart to UEFI allows users to enter the UEFI automatically when turning on the PC. By enabling this function, the PC will enter the UEFI directly after you restart.



ASRock Good Night LED

ASRock Good Night LED technology offers you a better sleeping environment by extinguishing the unessential LEDs. By enabling Good Night LED in the BIOS, the Power/HDD LEDs will be switched off when the system is powered on. Good Night LED will automatically switch off the Power and Keyboard LEDs when the system enters into Standby/Hibernation mode as well.



ASRock USB Key

In a world where time is money, why waste precious time everyday typing usernames to log in to Windows? Why should we even bother memorizing those foot long passwords? Just plug in the USB Key and let your computer log in to windows automatically!



ASRock Home Cloud

This motherboard supports remote wake with the onboard Intel LAN, so you can connect with your PC from anywhere in the world. You will be able to power your PC on or turn it off, monitor and take control of it remotely with another smartphone, tablet or computer.



ASRock FAN-Tastic Tuning

ASRock FAN-Tastic Tuning is included in A-Tuning. Configure up to five different fan speeds using the graph. The fans will automatically shift to the next speed level when the assigned temperature is met.



ASRock Distortion-Free Slot

ASRock's new pin design for the memory slots and PCIe slots may appear to be the same as former designs, but actually effectively reduces distortion and promotes performance, because we strive for perfection even in the most trivial details.

1.4 Motherboard Layout

Z87 Extreme6/ac

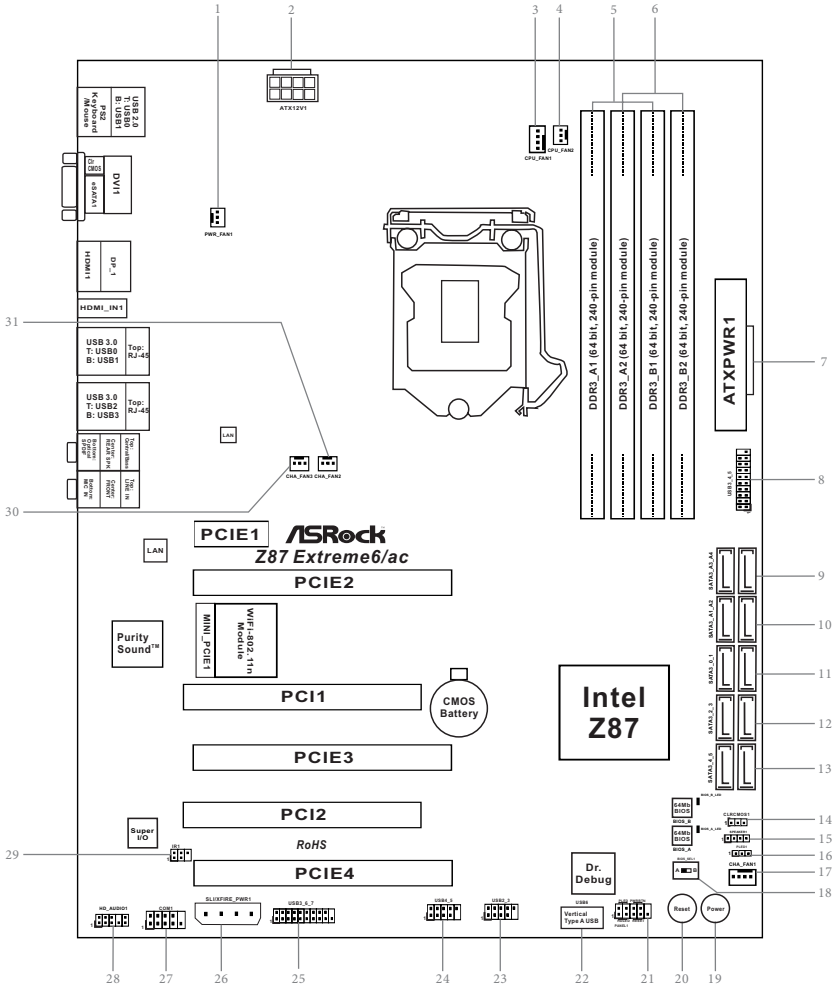

Z87 Extreme6

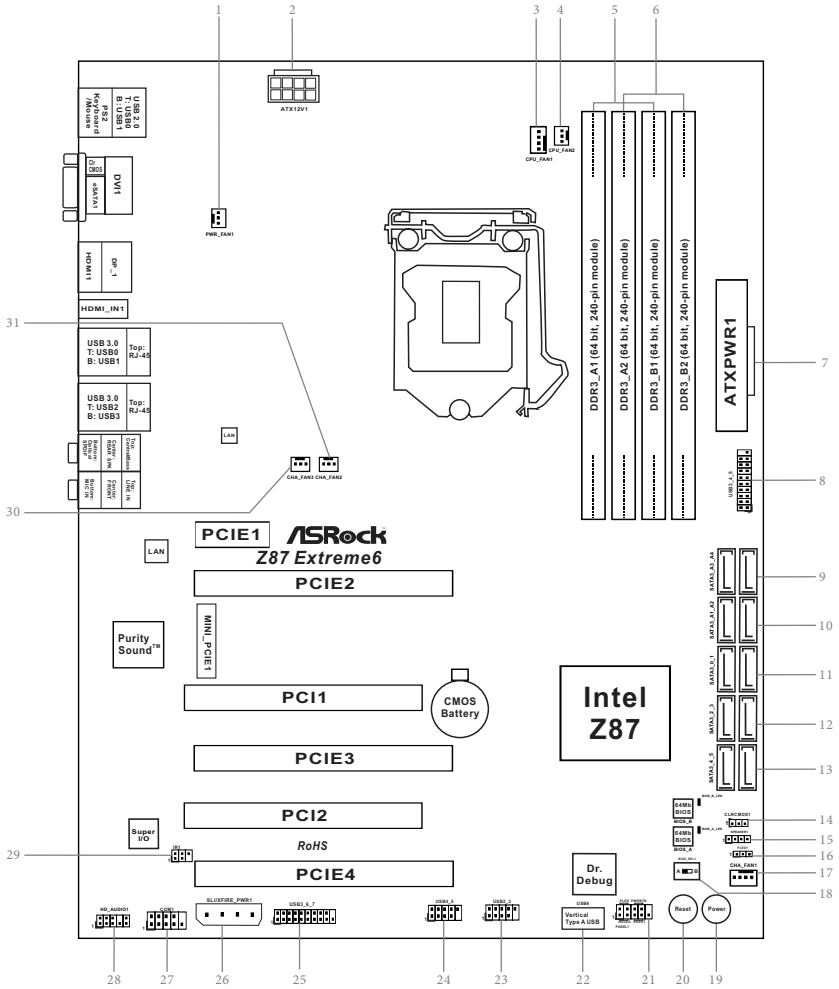

| No. | Description |
|-----|--|
| 1 | Power Fan Connector (PWR_FAN1) |
| 2 | ATX 12V Power Connector (ATX12V1) |
| 3 | CPU Fan Connector (CPU_FAN1) |
| 4 | CPU Fan Connector (CPU_FAN2) |
| 5 | 2 x 240-pin DDR3 DIMM Slots (DDR3_A1, DDR3_B1) |
| 6 | 2 x 240-pin DDR3 DIMM Slots (DDR3_A2, DDR3_B2) |
| 7 | ATX Power Connector (ATXPWR1) |
| 8 | USB 3.0 Header (USB3_4_5) |
| 9 | SATA3 Connectors (SATA3_A3_A4) |
| 10 | SATA3 Connectors (SATA3_A1_A2) |
| 11 | SATA3 Connectors (SATA3_0_1) |
| 12 | SATA3 Connectors (SATA3_2_3) |
| 13 | SATA3 Connectors (SATA3_4_5) |
| 14 | Clear CMOS Jumper (CLRCMOS1) |
| 15 | Chassis Speaker Header (SPEAKER1) |
| 16 | Power LED Header (PLED1) |
| 17 | Chassis Fan Connector (CHA_FAN1) |
| 18 | BIOS Selection Switch (BIOS_SEL1) |
| 19 | Power Switch (PWRBTN1) |
| 20 | Reset Switch (RSTBTN1) |
| 21 | System Panel Header (PANEL1) |
| 22 | Vertical Type A USB 2.0 (USB6) |
| 23 | USB 2.0 Header (USB2_3) |
| 24 | USB 2.0 Header (USB4_5) |
| 25 | USB 3.0 Header (USB3_6_7) |
| 26 | SLI/XFIRE Power Connector (SLI/XFIRE_PWR1) |
| 27 | COM Port Header (COM1) |
| 28 | Front Panel Audio Header (HD_AUDIO1) |
| 29 | Infrared Module Header (IR1) |
| 30 | Chassis Fan Connector (CHA_FAN3) |
| 31 | Chassis Fan Connector (CHA_FAN2) |

1.5 I/O Panel

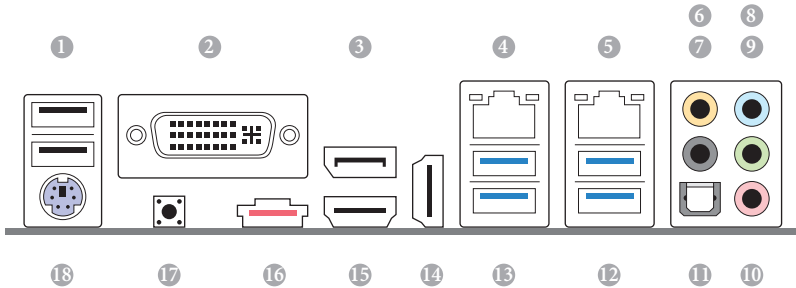

| No. | Description | No. | Description |
|-----|---------------------------------|-----|--|
| 1 | USB 2.0 Ports (USB01) | 11 | Optical SPDIF Out Port |
| 2 | DVI-I Port | 12 | USB 3.0 Ports (USB3_23) (ASMedia Hub) |
| 3 | Display Port | 13 | USB 3.0 Ports (USB3_01) (ASMedia Hub) |
| 4 | LAN RJ-45 Port (Intel® I217V)* | 14 | HDMI-In Port |
| 5 | LAN RJ-45 Port (Intel® I211AT)* | 15 | HDMI-Out Port |
| 6 | Central / Bass (Orange) | 16 | eSATA Connector*** |
| 7 | Rear Speaker (Black) | 17 | Clear CMOS Switch |
| 8 | Line In (Light Blue) | 18 | PS/2 Mouse/Keyboard Port |
| 9 | Front Speaker (Lime)** | | |
| 10 | Microphone (Pink) | | |

* There are two LEDs on each LAN port. Please refer to the table below for the LAN port LED indications.

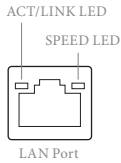

| Activity / Link LED | | Speed LED | |
|---------------------|---------------|-----------|--------------------|
| Status | Description | Status | Description |
| Off | No Link | Off | 10Mbps connection |
| Blinking | Data Activity | Orange | 100Mbps connection |
| On | Link | Green | 1Gbps connection |

** If you use a 2-channel speaker, please connect the speaker's plug into "Front Speaker Jack". See the table below for connection details in accordance with the type of speaker you use.

| Audio Output Channels | Front Speaker (No. 9) | Rear Speaker (No. 7) | Central / Bass (No. 6) | Line In (No. 8) |
|-----------------------|-----------------------|----------------------|------------------------|-----------------|
| 2 | V | -- | -- | -- |
| 4 | V | V | -- | -- |
| 6 | V | V | V | -- |
| 8 | V | V | V | V |



To enable Multi-Streaming, you need to connect a front panel audio cable to the front panel audio header. After restarting your computer, you will find the "Mixer" tool on your system. Please select "Mixer Toolbox" , click "Enable playback multi-streaming", and click "ok". Choose "2CH", "4CH", "6CH", or "8CH" and then you are allowed to select "Realtek HDA Primary output" to use the Rear Speaker, Central/Bass, and Front Speaker, or select "Realtek HDA Audio 2nd output" to use the front panel audio.

*** The eSATA connector supports SATA with cables within 1 meters.

1.6 WiFi-802.11n Module and ASRock WiFi 2.4GHz Antenna (for Z87 Extreme6/ac only)

WiFi + BT Module

This motherboard comes with an exclusive WiFi 802.11 a/b/g/n/ac + BT v4.0 module that offers support for WiFi 802.11 a/b/g/n/ac connectivity standards and Bluetooth v4.0. WiFi + BT module is an easy-to-use wireless local area network (WLAN) adapter to support WiFi + BT. Bluetooth v4.0 standard features Smart Ready technology that adds a whole new class of functionality into the mobile devices including Apple's most recent iPhone 4S. BT 4.0 also includes Low Energy Technology and ensures extraordinary low power consumption for PCs. The 2T2R WiFi solution sets a WiFi high speed standard and offers max link rate up to 867Mbps.

* The transmission speed may vary according to the environment.

* The WiFi + BT module is supported under Windows® 8 / 8 64-bit / 7 / 7 64-bit only.



ASRock WiFi 2.4GHz Antenna

Installing the SMA Wi-Fi Antenna Cables

Step 1



Prepare the SMA Wi-Fi Antenna Cables that come with the package.

Step 2

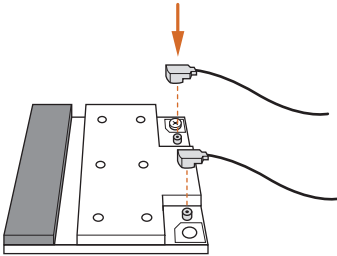

Locate the WiFi Module that is installed on the motherboard's mini-PCIe slot. Then attach the SMA Wi-Fi Antenna Cables to the WiFi Module.

Step 3

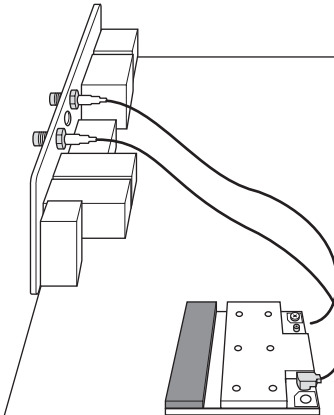

Insert the RP-SMA Wi-Fi Antenna Connectors to the antenna ports on the I/O shield

Step 4

Fasten the screw nuts to secure the connectors.

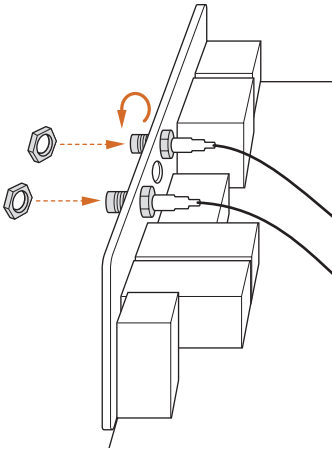

Chapter 2 Installation

This is an ATX form factor motherboard. Before you install the motherboard, study the configuration of your chassis to ensure that the motherboard fits into it.

Pre-installation Precautions

Take note of the following precautions before you install motherboard components or change any motherboard settings.

- Make sure to unplug the power cord before installing or removing the motherboard. Failure to do so may cause physical injuries to you and damages to motherboard components.
- In order to avoid damage from static electricity to the motherboard's components, NEVER place your motherboard directly on a carpet. Also remember to use a grounded wrist strap or touch a safety grounded object before you handle the components.
- Hold components by the edges and do not touch the ICs.
- Whenever you uninstall any components, place them on a grounded anti-static pad or in the bag that comes with the components.
- When placing screws to secure the motherboard to the chassis, please do not over-tighten the screws! Doing so may damage the motherboard.

2.1 Installing the CPU



1. Before you insert the 1150-Pin CPU into the socket, please check if the **PnP cap** is on the socket, if the CPU surface is unclean, or if there are any **bent pins** in the socket. Do not force to insert the CPU into the socket if above situation is found. Otherwise, the CPU will be seriously damaged.
2. Unplug all power cables before installing the CPU.

1

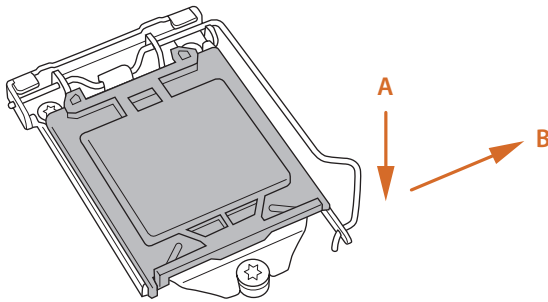

2

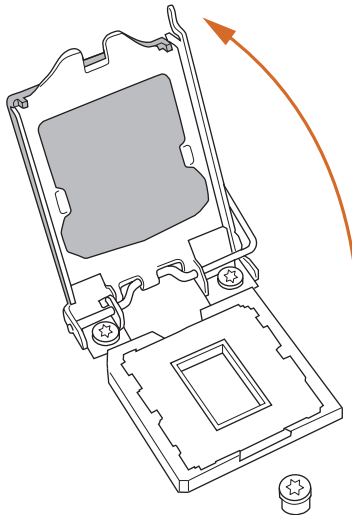

3

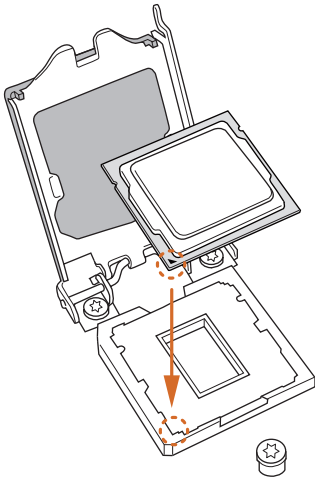

4

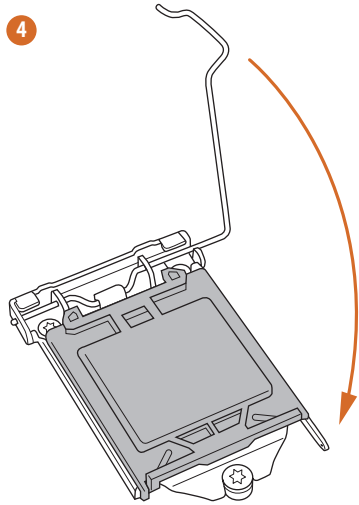

5

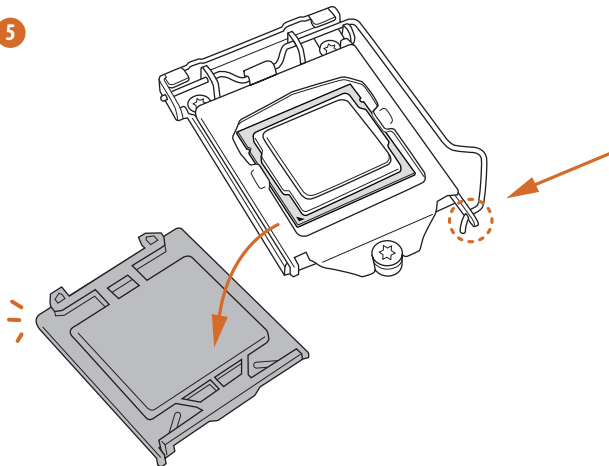



Please save and replace the cover if the processor is removed. The cover must be placed if you wish to return the motherboard for after service.

2.2 Installing the CPU Fan and Heatsink

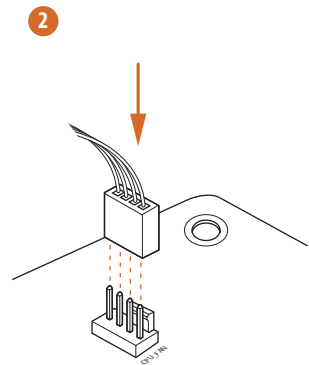
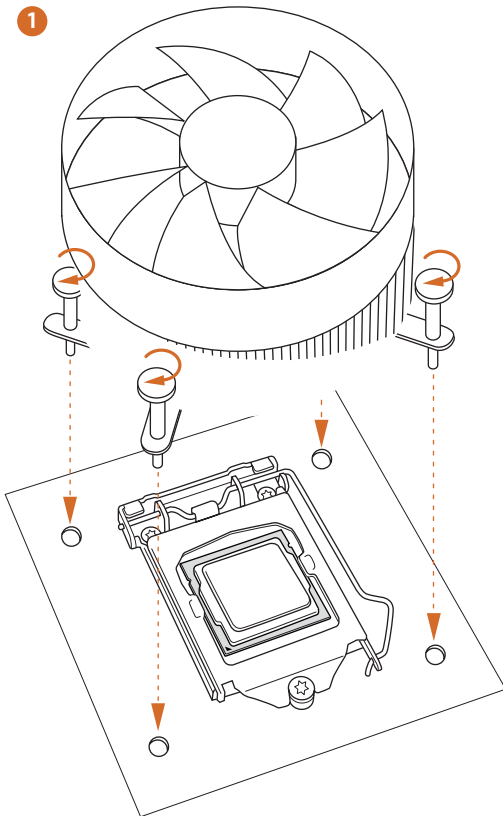
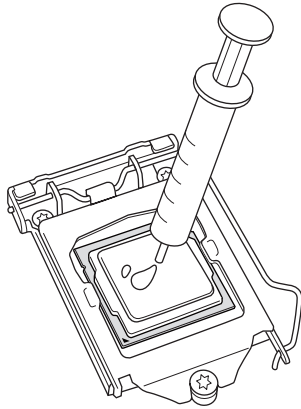

2.3 Installing Memory Modules (DIMM)

This motherboard provides four 240-pin DDR3 (Double Data Rate 3) DIMM slots, and supports Dual Channel Memory Technology.



1. For dual channel configuration, you always need to install identical (the same brand, speed, size and chip-type) DDR3 DIMM pairs.
2. It is unable to activate Dual Channel Memory Technology with only one or three memory module installed.
3. It is not allowed to install a DDR or DDR2 memory module into a DDR3 slot; otherwise, this motherboard and DIMM may be damaged.

Dual Channel Memory Configuration

| Priority | DDR3_A1 | DDR3_A2 | DDR3_B1 | DDR3_B2 |
|----------|-----------|-----------|-----------|-----------|
| 1 | | Populated | | Populated |
| 2 | Populated | | Populated | |
| 3 | Populated | Populated | Populated | Populated |



The DIMM only fits in one correct orientation. It will cause permanent damage to the motherboard and the DIMM if you force the DIMM into the slot at incorrect orientation.

1

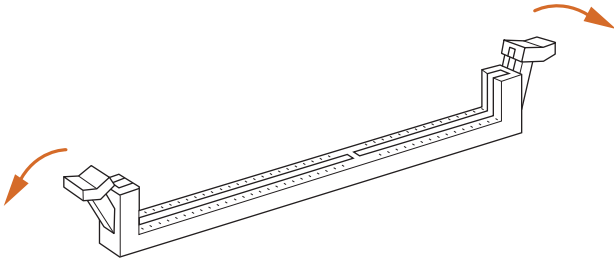

2

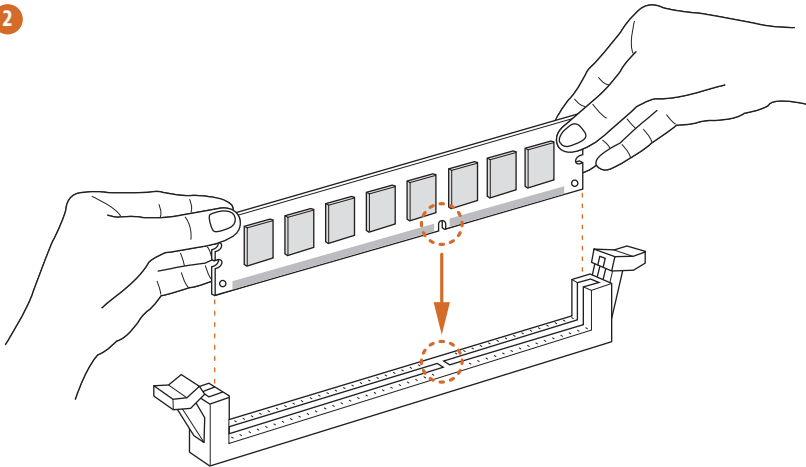

3

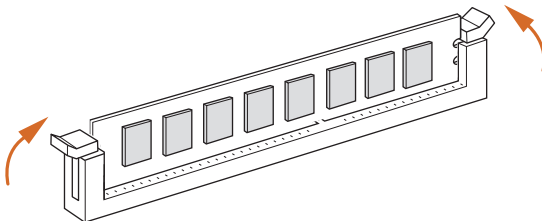

2.4 Expansion Slots (PCI and PCI Express Slots)

There are 2 PCI slots, 4 PCI Express slots, and 1 mini-PCI Express slot on the motherboard.



Before installing an expansion card, please make sure that the power supply is switched off or the power cord is unplugged. Please read the documentation of the expansion card and make necessary hardware settings for the card before you start the installation.

PCI slot:

The PCI1 and PCI2 slots are used to install expansion cards that have 32-bit PCI interface.

PCIe slots:

PCIe1 (PCIe 2.0 x1 slot) is used for PCI Express x1 lane width cards.

PCIe2 (PCIe 3.0 x16 slot) is used for PCI Express x16 lane width graphics cards.

PCIe3 (PCIe 3.0 x16 slot) is used for PCI Express x8 lane width graphics cards.

PCIe4 (PCIe 3.0 x16 slot) is used for PCI Express x4 lane width graphics cards.

mini-PCIe slots:

MINI_PCIE1 (mini-PCIe slot) is used for WiFi module.

PCIe Slot Configurations

| | PCIe2 | PCIe3 | PCIe4 |
|---|-------|-------|-------|
| Single Graphics Card | x16 | N/A | N/A |
| Two Graphics Cards in CrossFireX™ or SLI™ Mode | x8 | x8 | N/A |
| Three Graphics Cards in 3-Way CrossFireX™ Mode | x8 | x4 | x4 |



For a better thermal environment, please connect a chassis fan to the motherboard's chassis fan connector (CHA_FAN1, CHA_FAN2 or CHA_FAN3) when using multiple graphics cards.

2.5 Jumpers Setup

The illustration shows how jumpers are setup. When the jumper cap is placed on the pins, the jumper is “Short”. If no jumper cap is placed on the pins, the jumper is “Open”. The illustration shows a 3-pin jumper whose pin1 and pin2 are “Short” when a jumper cap is placed on these 2 pins.

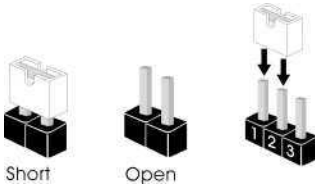

Clear CMOS Jumper
(CLR CMOS1)
(see p.11 or p.12, No. 14)

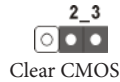

CLR CMOS1 allows you to clear the data in CMOS. To clear and reset the system parameters to default setup, please turn off the computer and unplug the power cord from the power supply. After waiting for 15 seconds, use a jumper cap to short pin2 and pin3 on CLR CMOS1 for 5 seconds. However, please do not clear the CMOS right after you update the BIOS. If you need to clear the CMOS when you just finish updating the BIOS, you must boot up the system first, and then shut it down before you do the clear-CMOS action. Please be noted that the password, date, time, and user default profile will be cleared only if the CMOS battery is removed.



The Clear CMOS Switch has the same function as the Clear CMOS jumper.

2.6 Onboard Headers and Connectors



Onboard headers and connectors are NOT jumpers. Do NOT place jumper caps over these headers and connectors. Placing jumper caps over the headers and connectors will cause permanent damage to the motherboard.

System Panel Header

(9-pin PANEL1)

(see p.11 or p.12, No. 21)

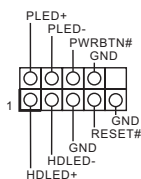

Connect the power switch, reset switch and system status indicator on the chassis to this header according to the pin assignments below. Note the positive and negative pins before connecting the cables.



PWRBTN (Power Switch):

Connect to the power switch on the chassis front panel. You may configure the way to turn off your system using the power switch.

RESET (Reset Switch):

Connect to the reset switch on the chassis front panel. Press the reset switch to restart the computer if the computer freezes and fails to perform a normal restart.

PLED (System Power LED):

Connect to the power status indicator on the chassis front panel. The LED is on when the system is operating. The LED keeps blinking when the system is in S1/S3 sleep state. The LED is off when the system is in S4 sleep state or powered off (S5).

HDLED (Hard Drive Activity LED):

Connect to the hard drive activity LED on the chassis front panel. The LED is on when the hard drive is reading or writing data.

The front panel design may differ by chassis. A front panel module mainly consists of power switch, reset switch, power LED, hard drive activity LED, speaker and etc. When connecting your chassis front panel module to this header, make sure the wire assignments and the pin assignments are matched correctly.

Power LED Header
 (3-pin PLED1)
 (see p.11 or p.12, No. 16)

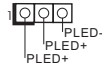

Please connect the chassis power LED to this header to indicate the system's power status.

Serial ATA3 Connectors
 (SATA3_0_1:
 see p.11 or p.12, No. 11)
 (SATA3_2_3:
 see p.11 or p.12, No. 12)
 (SATA3_4_5:
 see p.11 or p.12, No. 13)
 (SATA3_A1_A2:
 see p.11 or p.12, No. 10)
 (SATA3_A3_A4:
 see p.11 or p.12, No. 9)



These ten SATA3 connectors support SATA data cables for internal storage devices with up to 6.0 Gb/s data transfer rate. If the eSATA port on the rear I/O has been connected, the internal SATA3_A4 will not function. To minimize the boot time, use Intel® Z87 SATA ports (SATA3_0) for your bootable devices.

USB 2.0 Headers
 (9-pin USB2_3)
 (see p.11 or p.12, No. 23)
 (9-pin USB4_5)
 (see p.11 or p.12, No. 24)

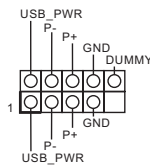

Besides four USB 2.0 ports on the I/O panel, there are three headers and one port on this motherboard. Each USB 2.0 header can support two ports.

(USB6)
 (see p.11 or p.12, No. 22)



USB 3.0 Headers
(19-pin USB3_4_5)
(see p.11 or p.12, No. 8)

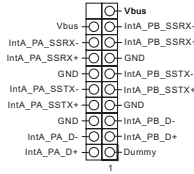

Besides four USB 3.0 ports on the I/O panel, there are two headers on this motherboard. Each USB 3.0 header can support two ports.

(19-pin USB3_6_7)
(see p.11 or p.12, No. 25)

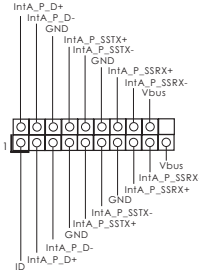

Front Panel Audio Header
(9-pin HD_AUDIO1)
(see p.11 or p.12, No. 28)

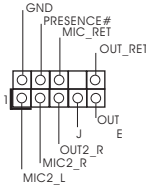

This header is for connecting audio devices to the front audio panel.



- High Definition Audio supports Jack Sensing, but the panel wire on the chassis must support HDA to function correctly. Please follow the instructions in our manual and chassis manual to install your system.
- If you use an AC'97 audio panel, please install it to the front panel audio header by the steps below:
 - Connect Mic_IN (MIC) to MIC2_L.
 - Connect Audio_R (RIN) to OUT2_R and Audio_L (LIN) to OUT2_L.
 - Connect Ground (GND) to Ground (GND).
 - MIC_RET and OUT_RET are for the HD audio panel only. You don't need to connect them for the AC'97 audio panel.
 - To activate the front mic, go to the "FrontMic" Tab in the Realtek Control panel and adjust "Recording Volume".

Chassis Speaker Header
(4-pin SPEAKER1)
(see p.11 or p.12, No. 15)

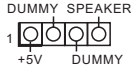

Please connect the chassis speaker to this header.

Chassis and Power Fan Connectors
(4-pin CHA_FAN1)
(see p.11 or p.12, No. 17)

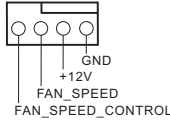

Please connect fan cables to the fan connectors and match the black wire to the ground pin.

(3-pin CHA_FAN2)
(see p.11 or p.12, No. 31)
(3-pin CHA_FAN3)
(see p.11 or p.12, No. 30)



(3-pin PWR_FAN1)
(see p.11 or p.12, No. 1)

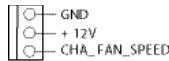

CPU Fan Connectors
(4-pin CPU_FAN1)
(see p.11 or p.12, No. 3)

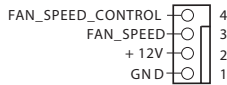

This motherboard provides a 4-Pin CPU fan (Quiet Fan) connector. If you plan to connect a 3-Pin CPU fan, please connect it to Pin 1-3.

(3-pin CPU_FAN2)
(see p.11 or p.12, No. 4)

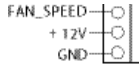

ATX Power Connector
(24-pin ATXPWR1)
(see p.11 or p.12, No. 7)

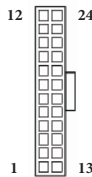

This motherboard provides a 24-pin ATX power connector. To use a 20-pin ATX power supply, please plug it along Pin 1 and Pin 13.

ATX 12V Power Connector
(8-pin ATX12V1)
(see p.11 or p.12, No. 2)

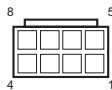

This motherboard provides an 8-pin ATX 12V power connector. To use a 4-pin ATX power supply, please plug it along Pin 1 and Pin 5.

SLI/XFIRE Power
Connector
(4-pin SLI/XFIRE_
PWR1)
(see p.11 or p.12, No. 26)



Please connect this
connector with a hard
disk power connector
when two graphics cards
are installed on this
motherboard.

Infrared Module Header
(5-pin IR1)
(see p.11 or p.12, No. 29)

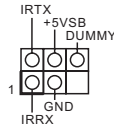

This header supports an optional
wireless transmitting and
receiving infrared module.

Serial Port Header
(9-pin COM1)
(see p.11 or p.12, No. 27)

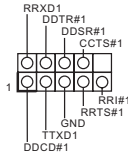

This COM1 header
supports a serial port
module.

2.7 Smart Switches

The motherboard has three smart switches: Power Switch, Reset Switch and Clear CMOS Switch, allowing users to quickly turn on/off the system, reset the system or clear the CMOS values.

Power Switch
(PWRBTN)
(see p.11 or p.12, No. 19)



Power Switch allows users to quickly turn on/off the system.

Reset Switch
(RSTBTN)
(see p.11 or p.12, No. 20)



Reset Switch allows users to quickly reset the system.

Clear CMOS Switch
(CLRBTN)
(see p.11 or p.12, No. 14)



Clear CMOS Switch allows users to quickly clear the CMOS values.



This function is workable only when you power off your computer and unplug the power supply.

BIOS Selection Switch
(BIOS_SEL1)
(see p.11 or p.12 No. 18)



BIOS Selection Switch allows the system to boot from either BIOS A or BIOS B.



This motherboard has two BIOS chips, a primary BIOS (BIOS_A) and a backup BIOS (BIOS_B), which enhances the safety and stability of your system. Normally, the system will work on the primary BIOS. However, if the primary BIOS is corrupted or damaged, just flip the BIOS Selection Switch to "B", then the backup BIOS will take over on the next system boot. After that, use "Secure Backup UEFI" in the UEFI Setup Utility to duplicate a working copy of the BIOS files to the primary BIOS to ensure normal system operation. For safety issues, users are not able to update the backup BIOS manually. Users may refer to the BIOS LEDs (BIOS_A_LED or BIOS_B_LED) to identify which BIOS is currently activated.

2.8 Dr. Debug

Dr. Debug is used to provide code information, which makes troubleshooting even easier. Please see the diagrams below for reading the Dr. Debug codes.

| Code | Description |
|-----------------------------------|--|
| 00 | Please check if the CPU is installed correctly and then clear CMOS. |
| 0d | Problem related to memory, VGA card or other devices. Please clear CMOS, re-install the memory and VGA card, and remove other USB, PCI devices. |
| 01 - 54 (except 0d), 5A- 60 | Problem related to memory. Please re-install the CPU and memory then clear CMOS. If the problem still exists, please install only one memory module or try using other memory modules. |
| 55 | The Memory could not be detected. Please re-install the memory and CPU. If the problem still exists, please install only one memory module or try using other memory modules. |
| 61 - 91 | Chipset initialization error. Please press reset or clear CMOS. |
| 92 - 99 | Problem related to PCI-E devices. Please re-install PCI-E devices or try installing them in other slots. If the problem still exists, please remove all PCI-E devices or try using another VGA card. |
| A0 - A7 | Problem related to IDE or SATA devices. Please re-install IDE and SATA devices. If the problem still exists, please clear CMOS and try removing all SATA devices. |
| b0 | Problem related to memory. Please re-install the CPU and memory. If the problem still exists, please install only one memory module or try using other memory modules. |

- b4 Problem related to USB devices. Please try removing all USB devices.
- b7 Problem related to memory. Please re-install the CPU and memory then clear CMOS. If the problem still exists, please install only one memory module or try using other memory modules.
- d6 The VGA could not be recognized. Please clear CMOS and try re-installing the VGA card. If the problem still exists, please try installing the VGA card in other slots or use other VGA cards.
- d7 The Keyboard and mouse could not be recognized. Please try re-installing the keyboard and mouse.
- d8 Invalid Password.
- FF Please check if the CPU is installed correctly and then clear CMOS.

2.9 Front USB 3.0 Panel Installation Guide

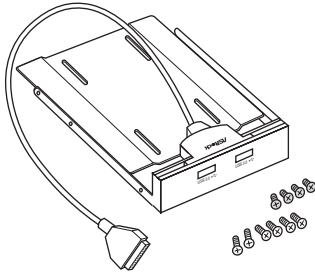

Step 1

Prepare the bundled Front USB 3.0 Panel with 2.5" HDD/SSD Rack, four HDD screws, and six chassis screws.

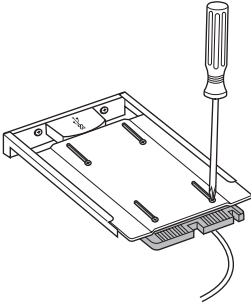

Step 2

Screw the 2.5" HDD/SSD to the Front USB 3.0 Panel with 2.5" HDD/SSD Rack with four HDD screws.

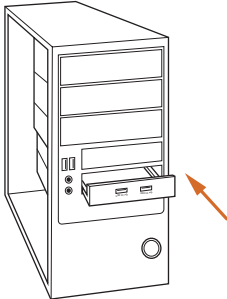

Step 3

Intall the Front USB 3.0 Panel with 2.5" HDD/SSD Rack into the 2.5" drive bay of the chassis.

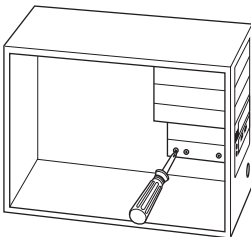

Step 4

Screw the Front USB 3.0 Panel with 2.5" HDD/SSD Rack to the drive bay with six chassis screws.

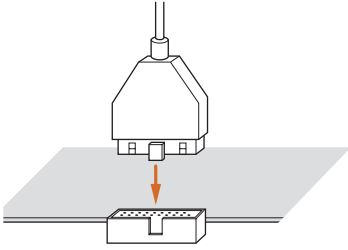

Step 5

Plug the Front USB 3.0 cable into the USB 3.0 header (USB3_4_5 or USB3_6_7) on the motherboard.

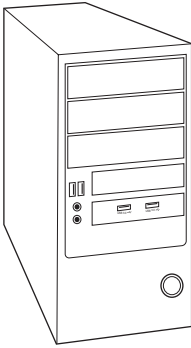

Step 6

The Front USB 3.0 Panel with 2.5" HDD/SSD Rack is ready to use.

2.10 Rear USB 3.0 Bracket Installation Guide

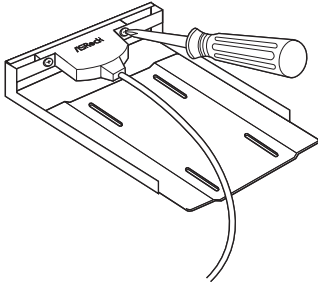

Step 1

Unscrew the two screws from the Front USB 3.0 Panel with 2.5" HDD/SSD Rack.

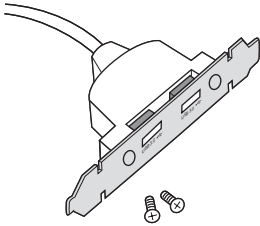

Step 2

Put the USB 3.0 cable and the bundled rear USB 3.0 bracket together.

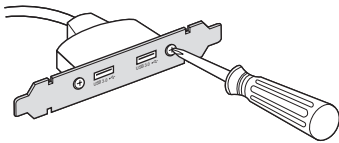

Step 3

Screw the two screws into the rear USB 3.0 bracket.

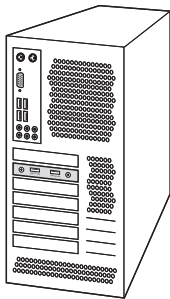

Step 4

Put the rear USB 3.0 bracket into the chassis.

2.11 Using the HDMI-In Port

The HDMI-In port on this motherboard lets you easily switch between PC screen (on-board VGA) and external video source on the same monitor. This function saves you the hassle of switching cables back and forth when you want to display the screen of another device, such as smartphone, tablet, camcorder, DVD player, or another PC, onto the PC monitor.

Another useful feature of this function is that external video source can be viewed even when your PC is in standby mode or powered off. For example, you can play smartphone games or watch tablet video on your PC screen.



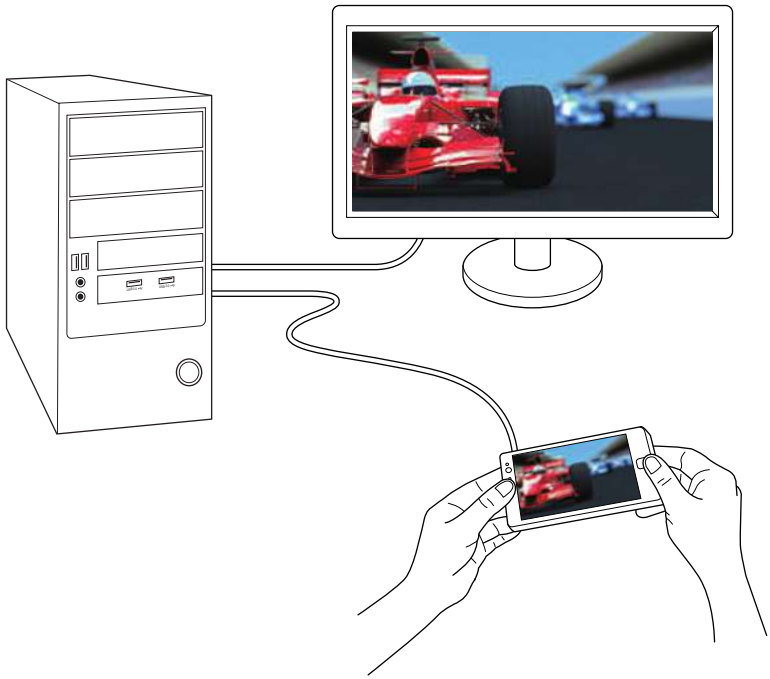

Connection Diagram

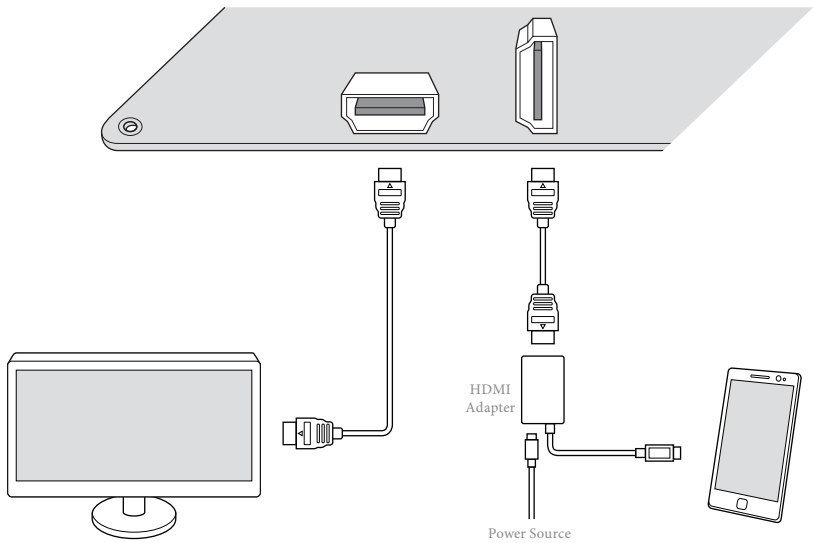

Step 1

Connect your monitor to the **HDMI-Out** port on the system via an HDMI cable.

Step 2

Connect an external devices with HDMI output to the **HDMI-In** port on the motherboard via an HDMI cable.

Step 3

Double-click the "A-Tuning"  icon on the desktop and find "HDMI-IN" function in "Tools" tab.

Step 4

Click the textbox and enter the action to set a hotkey. Then click **Apply** to apply the setting.

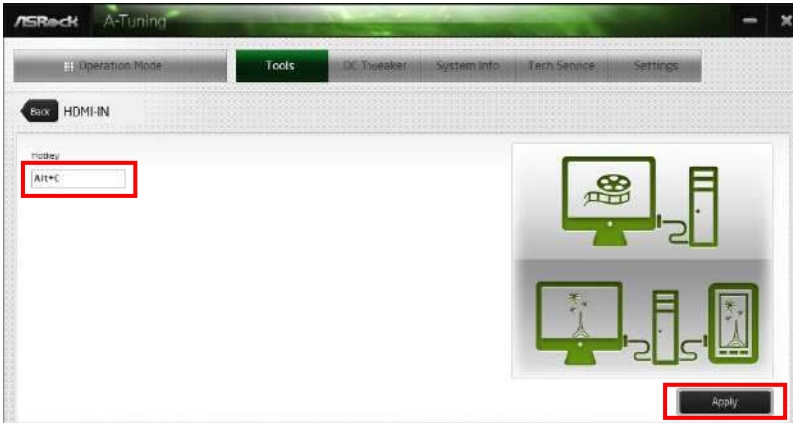
**Step 5**

Use the hotkey to switch between on-board PC screen or HDMI-In Source.



1. If there is no video displayed on your monitor, make sure that the cables are properly connected and make sure that "Deep S5" option in BIOS SETUP is set to [Disable].
2. If required, connect a power source to the adapter that lets the smartphone/tablet output HDMI signal.

2.12 SLI™ and Quad SLI™ Operation Guide

This motherboard supports NVIDIA® SLI™ and Quad SLI™ (Scalable Link Interface) technology that allows you to install up to two identical PCI Express x16 graphics cards. Currently, NVIDIA® SLI™ and Quad SLI™ technology supports Windows® 7 / 7 64-bit / 8 / 8 64-bit OS.



Requirements

1. You should only use identical SLI™-ready graphics cards that are NVIDIA® certified.
2. Make sure that your graphics card driver supports NVIDIA® SLI™ technology. Download the drivers from the NVIDIA® website: www.nvidia.com
3. Make sure that your power supply unit (PSU) can provide at least the minimum power your system requires. It is recommended to use a NVIDIA® certified PSU. Please refer to the NVIDIA® website for details.

2.12.1 Installing Two SLI™-Ready Graphics Cards

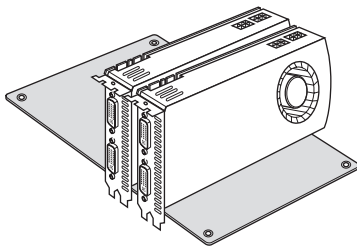

Step 1

Insert one graphics card into PCIe2 slot and the other graphics card to PCIe3 slot. Make sure that the cards are properly seated on the slots.

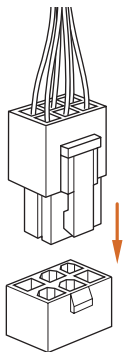

Step 2

If required, connect the auxiliary power source to the PCI Express graphics cards.

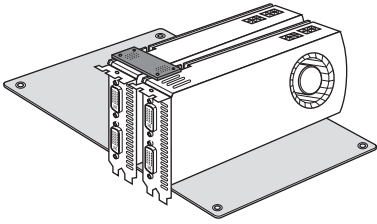
**Step 3**

Align and insert the ASRock SLI_Bridge_2S Card to the goldfingers on each graphics card. Make sure the ASRock SLI_Bridge_2S Card is firmly in place.

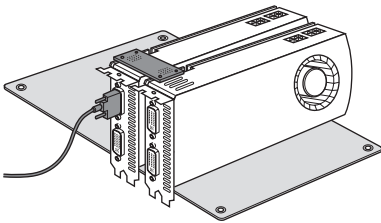

ASRock SLI_Bridge_2S Card

**Step 4**

Connect a VGA cable or a DVI cable to the monitor connector or the DVI connector of the graphics card that is inserted to PCIE2 slot.

2.12.2 Driver Installation and Setup

Install the graphics card drivers to your system. After that, you can enable the Multi-Graphics Processing Unit (GPU) in the NVIDIA® nView system tray utility. Please follow the below procedures to enable the multi-GPU.

For SLI™ and Quad SLI™ mode



Step 1

Double-click the **NVIDIA Control Panel** icon in the Windows® system tray.



Step 2

In the left pane, click **Set SLI and PhysX configuration**. Then select **Maximize 3D performance** and click **Apply**.

Step 3

Reboot your system.

Step 4

You can freely enjoy the benefits of SLI™ or Quad SLI™.

2.13 CrossFireX™, 3-Way CrossFireX™ and Quad CrossFireX™ Operation Guide

This motherboard supports CrossFireX™, 3-way CrossFireX™ and Quad CrossFireX™ that allows you to install up to three identical PCI Express x16 graphics cards. Currently CrossFireX™, 3-way CrossFireX™ and Quad CrossFireX™ are supported with Windows® 7 / 7 64-bit / 8 / 8 64-bit OS.



1. You should only use identical CrossFireX™-ready graphics cards that are AMD certified.
2. Make sure that your graphics card driver supports AMD CrossFireX™ technology. Download the drivers from the AMD's website: www.amd.com
3. Make sure that your power supply unit (PSU) can provide at least the minimum power your system requires. It is recommended to use a AMD certified PSU. Please refer to the AMD's website for details.
4. If you pair a 12-pipe CrossFireX™ Edition card with a 16-pipe card, both cards will operate as 12-pipe cards while in CrossFireX™ mode.
5. Different CrossFireX™ cards may require different methods to enable CrossFireX™. Please refer to AMD graphics card manuals for detailed installation guide.

2.13.1 Installing Two CrossFireX™-Ready Graphics Cards

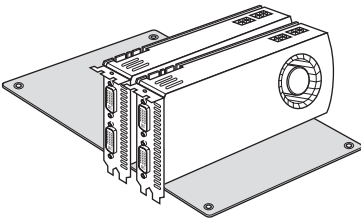

Step 1

Insert one graphics card into PCI E2 slot and the other graphics card to PCI E3 slot. Make sure that the cards are properly seated on the slots.



CrossFire Bridge

Step 2

Connect two graphics cards by installing a CrossFire Bridge on the CrossFire Bridge Interconnects on the top of the graphics cards. (The CrossFire Bridge is provided with the graphics card you purchase, not bundled with this motherboard. Please refer to your graphics card vendor for details.)

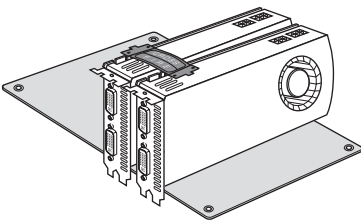

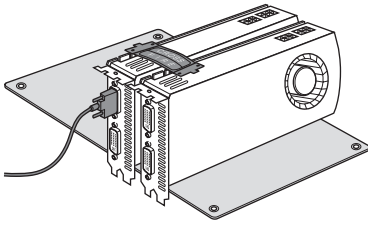

Step 3

Connect a VGA cable or a DVI cable to the monitor connector or the DVI connector of the graphics card that is inserted to PCIE2 slot.

2.13.2 Installing Three CrossFire™-Ready Graphics Cards

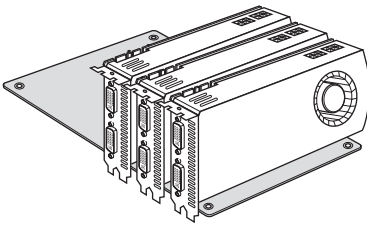

Step 1

Insert one graphics card into PCIE2 slot, another graphics card to PCIE3 slot, and the other graphics card to PCIE4 slot. Make sure that the cards are properly seated on the slots.



CrossFire Bridge

Step 2

Use one CrossFire Bridge to connect the graphics cards on PCIE2 and PCIE3 slots, and use the other CrossFire Bridge to connect the graphics cards on PCIE3 and PCIE4 slots. (The CrossFire Bridge is provided with the graphics card you purchase, not bundled with this motherboard. Please refer to your graphics card vendor for details.)

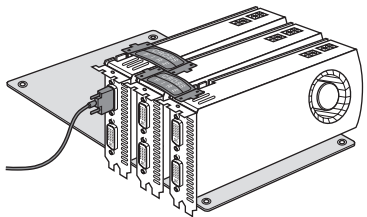
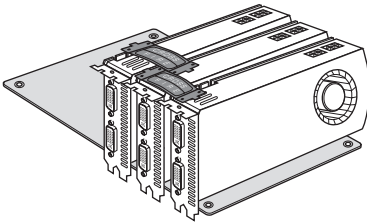

Step 3

Connect a VGA cable or a DVI cable to the monitor connector or the DVI connector of the graphics card that is inserted to PCIE2 slot.

2.13.3 Driver Installation and Setup

Step 1

Power on your computer and boot into OS.

Step 2

Remove the AMD drivers if you have any VGA drivers installed in your system.



The Catalyst Uninstaller is an optional download. We recommend using this utility to uninstall any previously installed Catalyst drivers prior to installation. Please check AMD's website for AMD driver updates.

Step 3

Install the required drivers and CATALYST Control Center then restart your computer. Please check AMD's website for details.



AMD Catalyst Control Center

Step 4

Double-click the **AMD Catalyst Control Center** icon in the Windows' system tray.



Step 5

In the left pane, click **Performance** and then **AMD CrossFireX™**. Then select **Enable AMD CrossFireX** and click **Apply**. Select the GPU number according to your graphics card and click **Apply**.

2.14 Dual LAN and Teaming Operation Guide

Dual LAN with Teaming enabled on this motherboard allows two single connections to act as one single connection for twice the transmission bandwidth, making data transmission more effective and improving the quality of transmission of distant images. Fault tolerance on the dual LAN network prevents network downtime by transferring the workload from a failed port to a working port.



The speed of transmission is subject to the actual network environment or status even with Teaming enabled.

Before setting up Teaming, please make sure whether your Switch (or Router) supports Teaming (IEEE 802.3ad Link Aggregation). You can specify a preferred adapter in Intel PROSet. Under normal conditions, the Primary adapter handles all non-TCP/IP traffic. The Secondary adapter will receive fallback traffic if the primary fails. If the Preferred Primary adapter fails, but is later restored to an active status, control is automatically switched back to the Preferred Primary adapter.

Step 1

From **Device Manager**, open the properties of a team.

Step 2

Click the **Settings** tab.

Step 3

Click the **Modify Team** button.

Step 4

Select the adapter you want to be the primary adapter and click the **Set Primary** button.

If you do not specify a preferred primary adapter, the software will choose an adapter of the highest capability (model and speed) to act as the default primary. If a failover occurs, another adapter becomes the primary. The adapter will, however, rejoin the team as a non-primary.

Chapter 3 Software and Utilities Operation

3.1 Installing Drivers

The Support CD that comes with the motherboard contains necessary drivers and useful utilities that enhance the motherboard's features.

Running The Support CD

To begin using the support CD, insert the CD into your CD-ROM drive. The CD automatically displays the Main Menu if "AUTORUN" is enabled in your computer. If the Main Menu does not appear automatically, locate and double click on the file "ASRSETUP.EXE" in the Support CD to display the menu.

Drivers Menu

The drivers compatible to your system will be auto-detected and listed on the support CD driver page. Please click **Install All** or follow the order from top to bottom to install those required drivers. Therefore, the drivers you install can work properly.

Utilities Menu

The Utilities Menu shows the application software that the motherboard supports. Click on a specific item then follow the installation wizard to install it.



To improve Windows 7 compatibility, please download and install the following hot fix provided by Microsoft.

"KB2720599": <http://support.microsoft.com/kb/2720599/en-us>

3.2 A-Tuning

A-Tuning is ASRock's multi purpose software suite with a new interface, more new features and improved utilities, including XFast RAM, Dehumidifier, Good Night LED, FAN-Tastic Tuning, OC Tweaker and a whole lot more.

3.2.1 Installing A-Tuning

When you install the all-in-one driver to your system from ASRock's support CD, A-Tuning will be auto-installed as well. After the installation, you will find the icon "A-Tuning" on your desktop. Double-click the "A-Tuning"  icon, A-Tuning main menu will pop up.

3.2.2 Using A-Tuning

There are five sections in AXTU main menu: Operation Mode, Tools, OC Tweaker, System Info and Tech Service.

Operation Mode

Choose an operation mode for your computer.

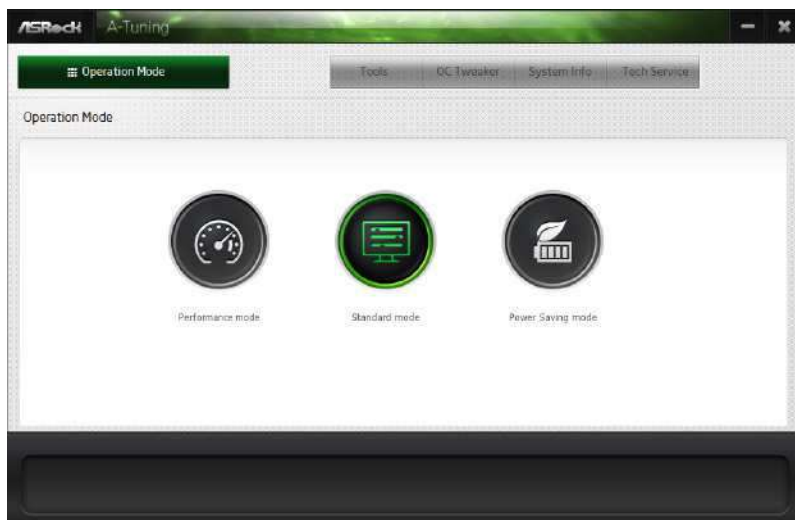

Tools

Various tools and utilities.

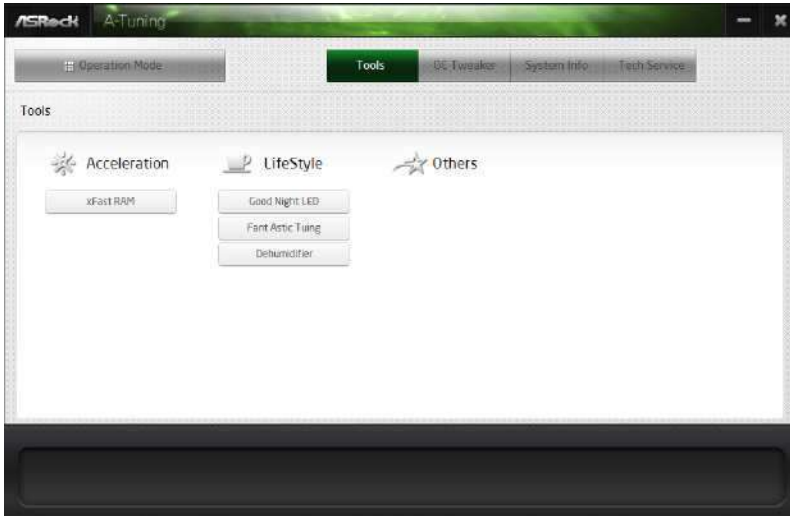

XFast RAM

Boost the system's performance and extend the HDD's or SSD's lifespan! Create a hidden partition, then assign which files should be stored in the RAM drive.

Fast Boot

Fast Boot minimizes your computer's boot time. Please note that Ultra Fast mode is only supported by Windows 8 and the VBIOS must support UEFI GOP if you are using an external graphics card.

OMG

Schedule the starting and ending hours of Internet access granted to other users. Place X marks on the time table to disable the Internet.

Good Night LED

Switch off the Power/HDD/LAN LEDs when the system is on, and automatically switch off the Power and Keyboard LEDs when the system enters into Standby/Hibernation mode.

FAN-Tastic Tuning

Configure up to five different fan speeds using the graph. The fans will automatically shift to the next speed level when the assigned temperature is met.

Dehumidifier

Prevent motherboard damages due to dampness. Enable this function and configure the period of time until the computer powers on, and the duration of the dehumidifying process.

HDMI-IN

Connect two different devices to one monitor and toggle between the primary and secondary screen without replugging the connectors every time. Please set a hotkey for switching between the two devices.

OC Tweaker

Configurations for overclocking the system.



System Info

View information about the system.

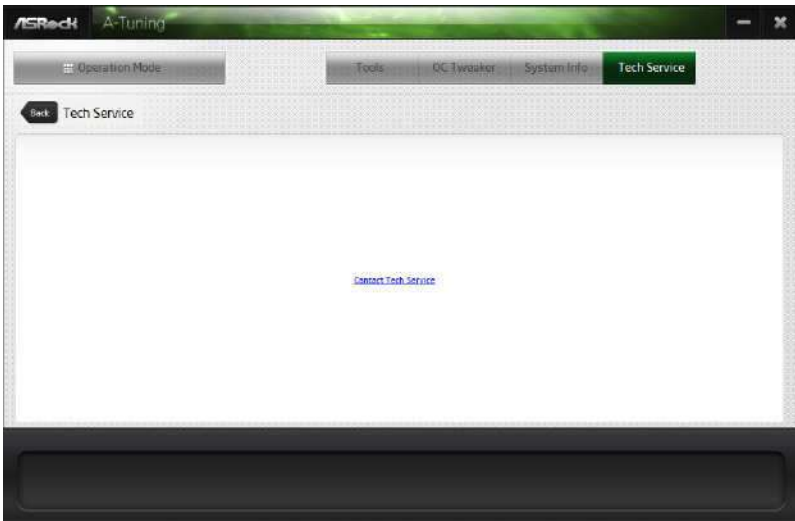

Tech Service

Contact Tech Service.

3.3 Intel® Rapid Start Technology

Intel® Rapid Start Technology enables your system to wake up faster from deep sleep, saving time and power consumption. Feel secure to know that your system will resume to working condition even if an unexpected power loss happens while the PC is in sleep mode.

3.3.1 System Requirements

- Confirm whether your motherboard supports this feature.
- Operating system: Microsoft Windows 8/7 (32- or 64-bit edition)
- Set the SATA mode to AHCI. If Windows 8/7 is already installed under IDE mode, directly changing the SATA mode to AHCI may cause Windows 8/7 to crash while booting. If your system is not in AHCI mode, please follow the instructions below.



There are certain risks. Please backup any important data before operating to avoid loss.

1. Press **Win + R** simultaneously in Windows 8/7, type "Regedit" into the word box then click **OK**.



2. Enter into **HKEY_LOCAL_MACHINE\SYSTEM\CurrentControlSet\services\msahci** in Windows Registry Editor. Double click on the value **Start** and change the value from **3** into **0**. Click on **OK**.

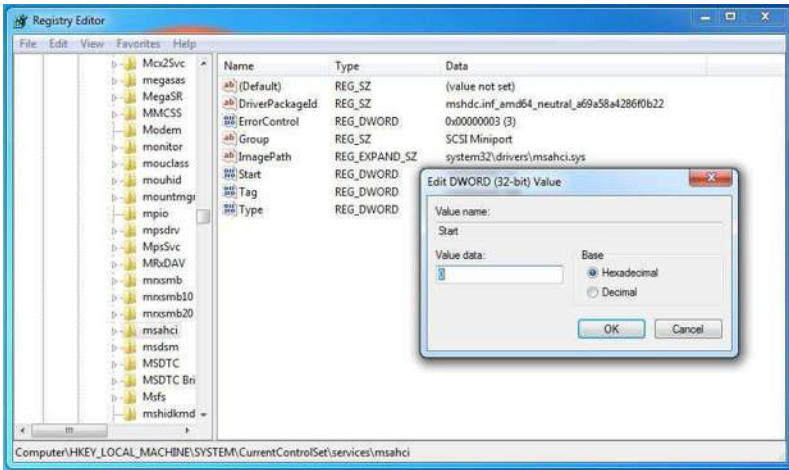

3. Exit the Registry Editor window and restart the computer.
4. Press **F2** to enter BIOS, then go to **Advanced** -> **Storage Configuration** and change SATA Mode to **AHCI**. Press **F10** to save changes and exit.
5. Enter Windows 8/7. Windows will discover the new device and install AHCI drivers automatically.

3.3.2 Setup Guide

Configuring Rapid Start

Step 1

Run ASRock Rapid Start utility from **Start** -> **All Programs** -> **ASRock Utility**.

Step 2

If you have more than one hard drives in your system, you must select one, then choose the **Partition Size** desired for your hidden partition and click on **Create**. The system will automatically create a hidden partition according to your settings. If there are SSD's installed into your system, it is recommended to create the partition on the SSD.



Step 3

When prompted to restart after the setup, click **Yes** to reboot.



Step 4

Double-click the Intel® Rapid Start Technology Manager icon  in the Windows system tray.

Step 5

Make sure Rapid Start is on. Drag the slider to configure the time. For example, if the timer value is set to ten minutes, the system will enable Rapid Start mode after entering sleep state for ten minutes. If the timer is set to 0 minutes, Windows will immediately enable Rapid Start mode as it enters sleep state.

**Using Rapid Start**

1. You may shut down the computer without terminating the applications or files you are executing currently. Click on Windows Start -> the arrow next to Shut down, and click on **Sleep**.

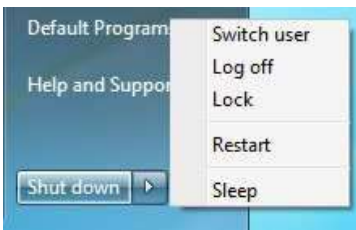

2. Windows system will enter sleep state.
3. According to your settings in Rapid Start Technology Manager, the system will automatically wake up and enable Rapid Start mode after entering sleep

state for a period of time. The power of the computer in Rapid Start mode can be cut off, it will not cause data loss of the programs or files you were executing before entering sleep state.

4. When you wish to continue to use the computer just hit the power button, the system will rapidly return to Windows, the programs and files which you were using before entering sleep state will be accessible immediately.

3.4 Intel® Smart Connect Technology

Intel® Smart Connect Technology is a feature that periodically wakes your computer from Windows® sleep state to refresh email or social networking applications. It saves your waiting time and keeps the content always up-to-date.

3.4.1 System Requirements

- Confirm whether your motherboard supports this feature.
- Operating system: Microsoft Windows 8/7 (32- or 64-bit edition)
- Set the SATA mode to AHCI. If Windows 8/7 is already installed under IDE mode, directly changing the SATA mode to AHCI may cause Windows 8/7 to crash while booting. If your system is not in AHCI mode, please follow the instructions below.



There are certain risks. Please backup any important data before operating to avoid loss.

1. Press **Win + R** simultaneously in Windows 8/7, type "Regedit" into the word box then click **OK**.



2. Enter into **HKEY_LOCAL_MACHINE\SYSTEM\CurrentControlSet\services\msahci** in Windows Registry Editor. Double click on the value **Start** and change the value from **3** into **0**. Click on **OK**.

3.4.2 Setup Guide

Installing ASRock Smart Connect Utility

Step 1

Install **ASRock Smart Connect Utility**, which is located in the folder at the following path of the Support CD: \ **ASRock Utility** > **Smart Connect**.

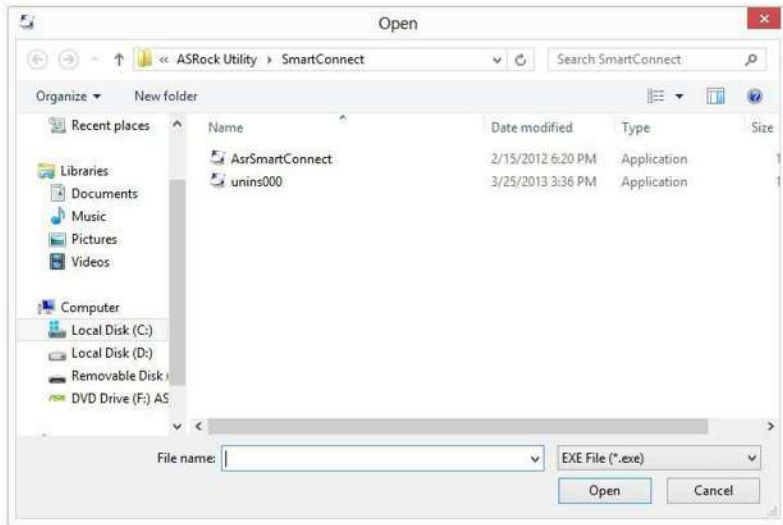

Step 2

Once installed, run ASRock Smart Connect from your desktop or go to Windows Start -> All Programs -> ASRock Utility.



Step 3

Click the **Add** button. Take Foxmail as an example, add Foxmail to the Application list.

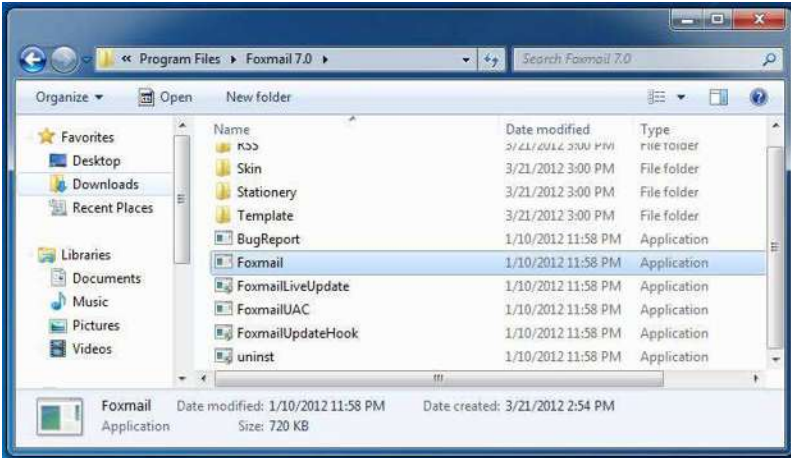
**Step 4**

Select Foxmail from the **Application List**, then click the arrow pointing right to add this application to the **Smart Connect List**.

**Step 5**

Click **Apply** to enable Smart Connect.

Step 6

Double-click the Intel® Smart Connect Technology Manager icon  in the Windows system tray.

Step 7

Drag the slider to configure how often the system will connect to the network to download updates. Shorter durations will provide more frequent updates, but may cause more power consumption.

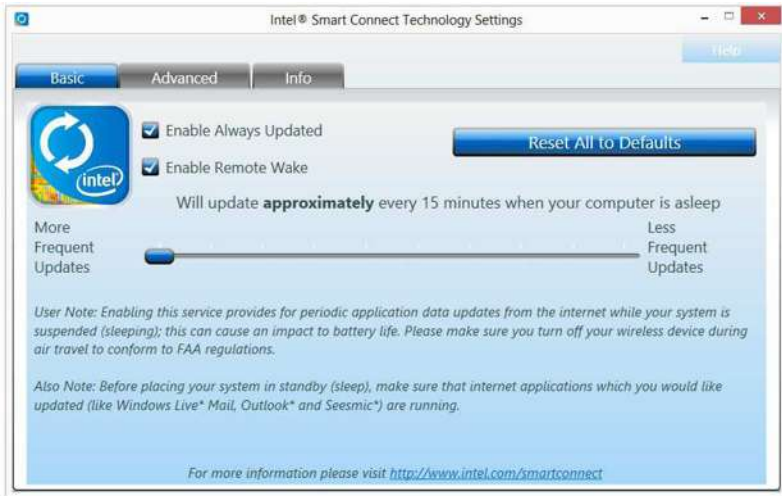

Using Smart Connect

1. Keep the applications which you wish to connect to the internet and receive updates while the system is in sleep state running. Foxmail for instance, keep Foxmail running.
2. Click on Windows Start -> the arrow next to Shut down, and click on **Sleep**.

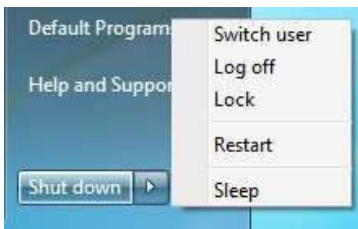

3. Windows system will enter sleep state.

4. The system will wake up from sleep state periodically, and then start to update Foxmail. The screen will not display anything so the computer can maintain minimum power usage. Afterwards, the system will automatically return to sleep state again.
5. Upon waking up the system, you will find the new mail that were sent to you during sleep state are already updated and ready to be read in Foxmail.

3.5 Intel® Remote Wake Technology

Intel® Remote Wake Technology allows you to use programs or services over the Internet to wake up your home computer from energy efficient sleep mode.

Before configuring this feature, verify the following.

- Remote Wake has been enabled in "Intel® Smart Connect Technology Manager".
- Make sure that the "PCI Device Power On" is enabled in UEFI SETUP UTILITY > Advanced > ACPI Configuration.

3.5.1 Configuring and Using MeshCentral

MeshCentral allows you to remotely wake up a PC from any network using a single web site. Just download and install the mesh agent on your computers and your computers will show up in the "My Devices" section of MeshCentral.com.

Creating a Mesh

Step 1

Login to Meshcentral.com.

If you have not created a MeshCentral account, go to MeshCentral.com and create a new account.

MeshCentral (Alpha)

Welcome

Connect with your home or office devices from anywhere in the world using MeshCentral, the remote monitoring and management web site. You will need to download and install a special management agent on your computers. Once installed, your computers will show up in the "My Devices" section of this web site and will be able to monitor them, power them on and off and take control of them.

Log In

User Name: asrock08
Password: [masked]
 Remember me next time. **Log In**

Use an OpenID provider: **Google** **YAHOO!**

Don't have an account? [Create one.](#)

[Terms & Privacy](#)

Step 2

Click the "My Account" tab. Then click on "New" to create a new mesh.

Add OpenID 



Administrative Meshes ( Manage  New  Install)

Step 3

A new mesh window will pop up. Enter a mesh name and password.

Step 4

Select all the checkboxes and click **Create Mesh**.

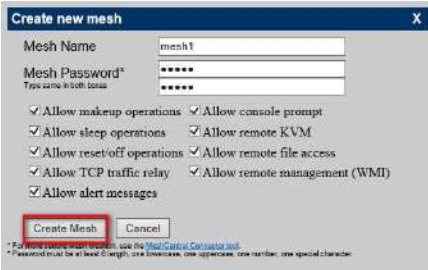

Create new mesh X

Mesh Name: mesh1

Mesh Password*
Type same in both boxes: *****

Allow makeup operations Allow console prompt
 Allow sleep operations Allow remote KVM
 Allow reset/off operations Allow remote file access
 Allow TCP traffic relay Allow remote management (WMI)
 Allow alert messages

Create Mesh Cancel

* For Windows Firewall exceptions, see the [Mesh Control Center](#) tool.
 * Password must be at least 8 length, one lowercase, one uppercase, one number, one special character.

Downloading and Installing Mesh Agent

Step 1

Click Install on the My Account page.

Add OpenID 



Administrative Meshes ( Manage  New  Install)

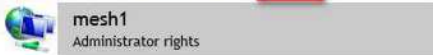

Step 2

Select the mesh and download both files. Make sure both files are in the same directory.

Step 3

Right-click on the MeshAgent.exe and select **Run as administrator**.

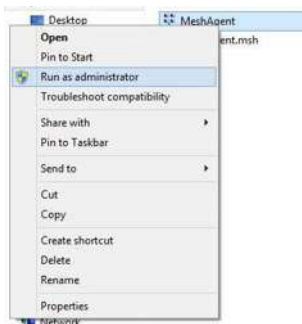

Step 4

Click **Install / Update**.

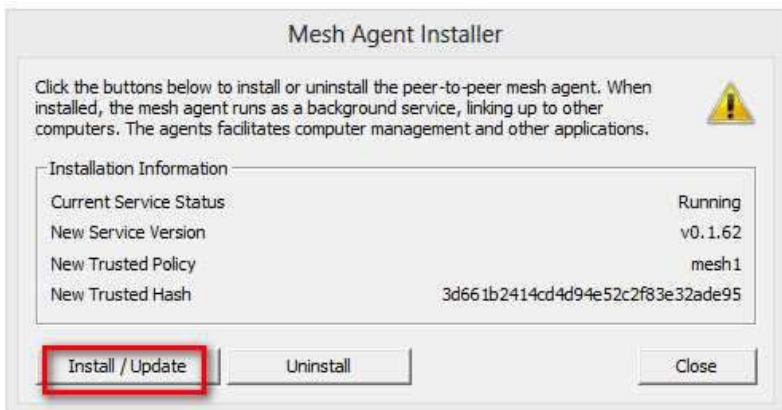

Step 5

Wait a minute for the New Machine to appear in "My Device".



Step 6

Check whether "Intel Remote Wake" appeared or not.

**Step 7**

Click on **Power Actions**.

Step 8

Click on **Wake** or **Sleep**.



Waking up a PC using mobile device.



Before waking up your home computer using a mobile device, please log out of MeshCentral on other previously used computers or devices.

Step 1

Login to meshcentral.com/m.

Step 2

Select a Machine.

Step 3

Click on **Wake** or **Sleep**.



Tutorial Video

3.5.2 Configuring and Using Splashtop

Splashtop is a remote desktop access software that lets you remotely access your home computer from your mobile device.

Before configuring this feature, verify that the "Remote Wake" has been enabled in "Intel® Smart Connect Technology Manager".

Setup Guide

Step 1

Download and install **Streamer** on your home computer, which is located in the folder at the following path of the Support CD: \ **ASRock Utility > Splashtop Streamer**. Then enter your Splashtop Account. If you have not created a Splashtop account, create one.

Step 2

Download and install "Splashtop 2" on your mobile device and log into the app.

Using Remote Wakeup

Step 1

In "Splashtop 2", tap the edit button next to an offline machine from the list.

Step 2

Tap "Wake up this computer".

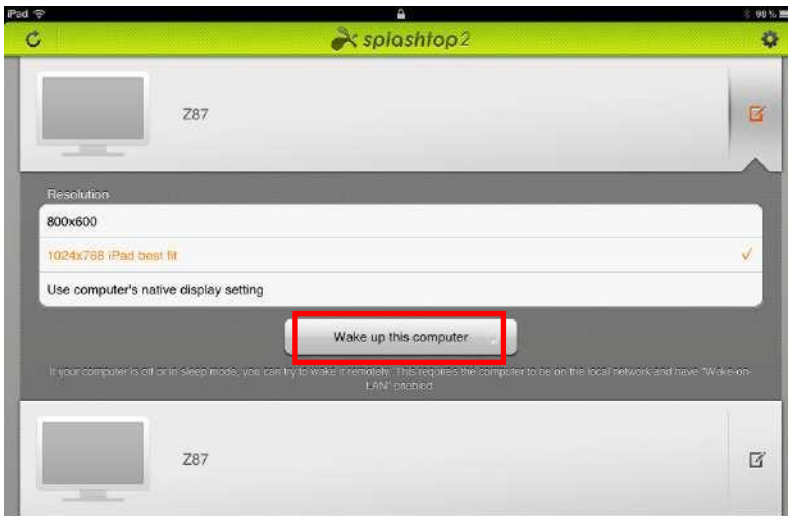

Using Remote Control

Step 1

In "Splashtop 2", tap an online machine from the list to connect to your home computer.



Step 2

Start remotely accessing your home computer.



The functionality and price of the Splashtop APP and subscription fee is subject to change. Please check www.splashtop.com for details.

Accessing Data

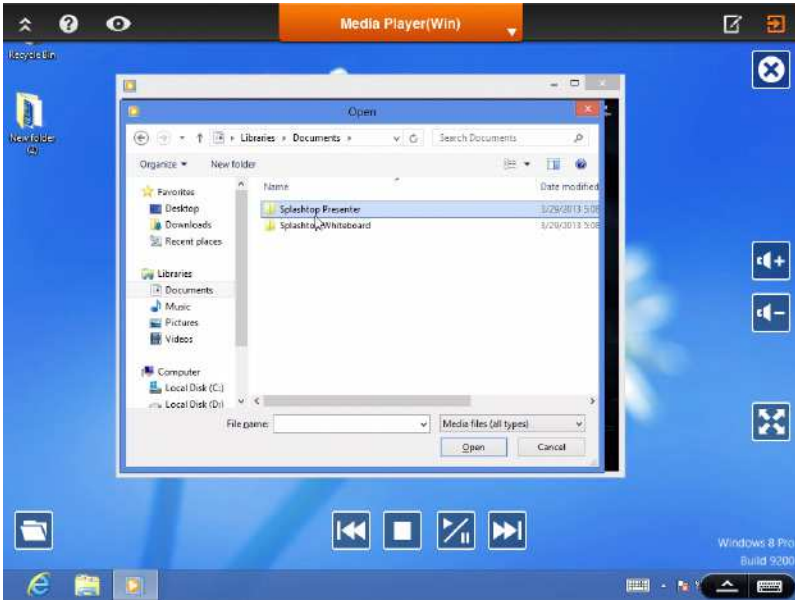

Playing Video



3.6 Start8

For those Windows 8 users who miss the Start Menu, Start8 is an ideal solution that brings back the familiar Start Menu along with added customizations for greater efficiency.

3.6.1 Installing Start8

Install **Start8**, which is located in the folder at the following path of the Support CD:
\\ASRock Utility > Start8.

3.6.2 Configuring Start8

Style

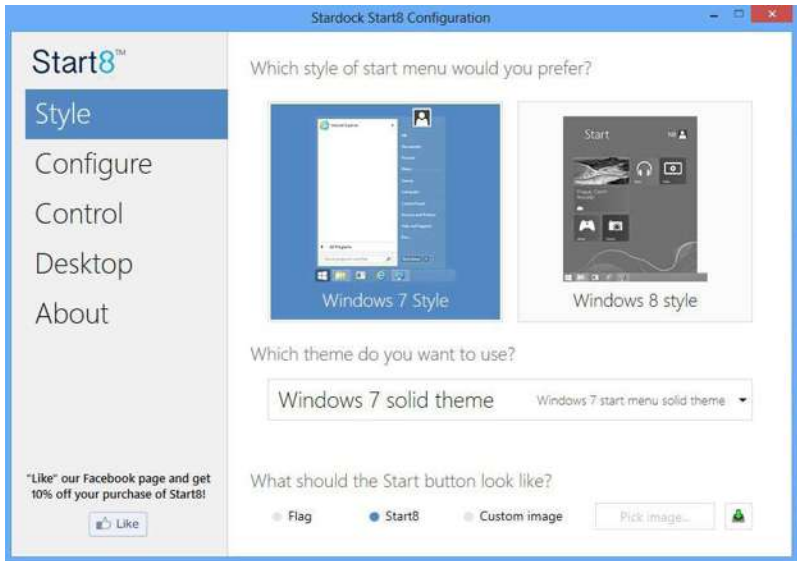

Select between the Windows 7 style and Windows 8 style Start Menu. Then select the theme of the Start Menu and customize the style of the Start icon.

Configure

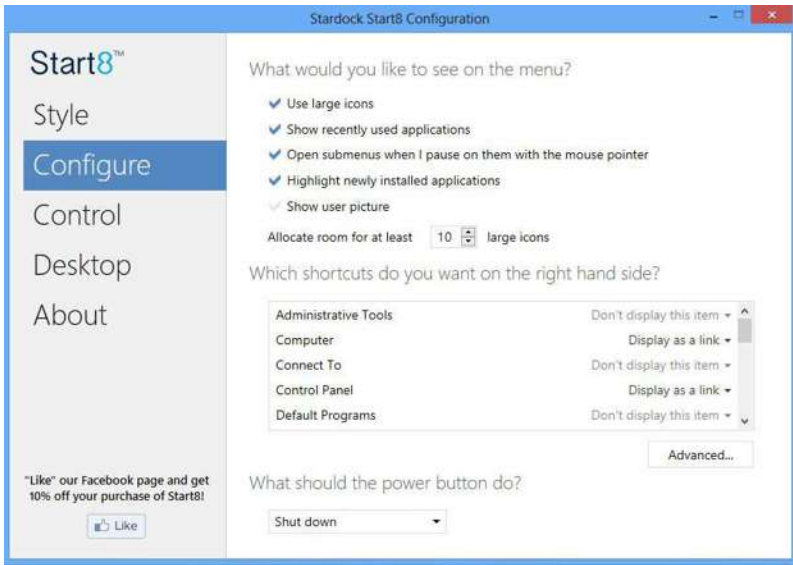

Configure provides configuration options, including icon sizes, which shortcuts you want Start Menu to display, quick access to recently used apps, the functionality of the power button, and more.

Control

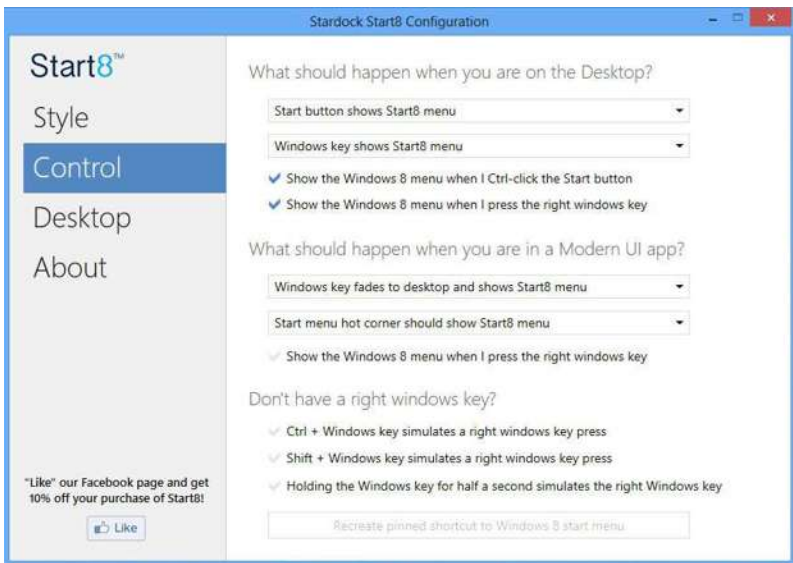

Control lets you configure what a click on the start button or a press on the Windows key does.

Desktop

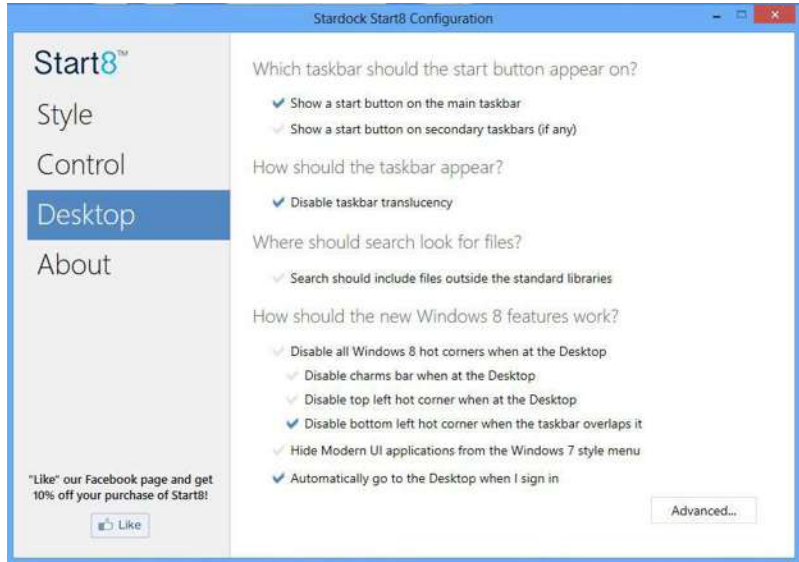

Desktop allows you to disable the hot corners when you are working on the desktop. It also lets you choose whether or not the system boots directly into desktop mode and bypass the Metro user interface.

About

Displays information about Start8.

Chapter 4 UEFI SETUP UTILITY

4.1 Introduction

ASRock Interactive UEFI is a blend of system configuration tools, cool sound effects and stunning visuals. Not only will it make BIOS setup less difficult but also a lot more amusing. This section explains how to use the UEFI SETUP UTILITY to configure your system. You may run the UEFI SETUP UTILITY by pressing <F2> or right after you power on the computer, otherwise, the Power-On-Self-Test (POST) will continue with its test routines. If you wish to enter the UEFI SETUP UTILITY after POST, restart the system by pressing <Ctl> + <Alt> + <Delete>, or by pressing the reset button on the system chassis. You may also restart by turning the system off and then back on.



Because the UEFI software is constantly being updated, the following UEFI setup screens and descriptions are for reference purpose only, and they may not exactly match what you see on your screen.

4.1.1 UEFI Menu Bar

The top of the screen has a menu bar with the following selections:

| | |
|--------------------|---|
| Main | For setting system time/date information |
| OC Tweaker | For overclocking configurations |
| Advanced | For advanced system configurations |
| Tool | Useful tools |
| H/W Monitor | Displays current hardware status |
| Boot | For configuring boot settings and boot priority |
| Security | For security settings |
| Exit | Exit the current screen or the UEFI Setup Utility |

4.1.2 Navigation Keys

Use <←→> key or <→> key to choose among the selections on the menu bar, and use <↑> key or <↓> key to move the cursor up or down to select items, then press <Enter> to get into the sub screen. You can also use the mouse to click your required item.

Please check the following table for the descriptions of each navigation key.

| Navigation Key(s) | Description |
|-------------------|--|
| + / - | To change option for the selected items |
| <Tab> | Switch to next function |
| <PGUP> | Go to the previous page |
| <PGDN> | Go to the next page |
| <HOME> | Go to the top of the screen |
| <END> | Go to the bottom of the screen |
| <F1> | To display the General Help Screen |
| <F4> | Toggle sound on/off |
| <F7> | Discard changes and exit the SETUP UTILITY |
| <F9> | Load optimal default values for all the settings |
| <F10> | Save changes and exit the SETUP UTILITY |
| <F12> | Print screen |
| <ESC> | Jump to the Exit Screen or exit the current screen |

4.2 Main Screen

When you enter the UEFI SETUP UTILITY, the Main screen will appear and display the system overview.



Active Page on Entry

Select the default page when entering the UEFI setup utility.

UEFI Guide

UEFI Guide is a quick tutorial for ASRock's UEFI setup Utility. You may abort the tutorial by pressing "esc".

4.3 OC Tweaker Screen

In the OC Tweaker screen, you can set up overclocking features.



Because the UEFI software is constantly being updated, the following UEFI setup screens and descriptions are for reference purpose only, and they may not exactly match what you see on your screen.

Advanced Turbo

You can use this option to increase your system performance. This option appears only when your CPU supports this function. This option appears only when you adopt K-Series CPU.

Load Optimized CPU OC Setting

You can use this option to load optimized CPU overclocking setting. Please note that overclocking may cause damage to your CPU and motherboard. It should be done at your own risk and expense. This option appears only when you adopt K-Series CPU.

Load Optimized GPU OC Setting

You can use this option to load optimized GPU overclocking setting. Please note that overclocking may cause damage to your GPU and motherboard. It should be done at your own risk and expense. This option appears only when you adopt K-Series CPU.

CPU Configuration

CPU Ratio

The CPU speed is determined by the CPU Ratio multiplied with the BCLK. Increasing the CPU Ratio will increase the internal CPU clock speed without affecting the clock speed of other components.

CPU Cache Ratio

The CPU Internal Bus Speed Ratio. The maximum should be the same as the CPU Ratio.

BCLK/PCIE Frequency

The CPU speed is determined by the CPU Ratio multiplied with the BCLK. Increasing the BCLK will increase the internal CPU clock speed but also affect the clock speed of other components.

Spread Spectrum

Enable Spread Spectrum to reduce electromagnetic interference for passing EMI tests. Disable to achieve higher clock speeds when overclocking.

Intel SpeedStep Technology

Intel SpeedStep technology allows processors to switch between multiple frequencies and voltage points for better power saving and heat dissipation.

Intel Turbo Boost Technology

Intel Turbo Boost Technology enables the processor to run above its base operating frequency when the operating system requests the highest performance state.

Filter PLL Frequency

CPU BCLK Filter Frequency. Choose 1.6 for better overclocking capabilities.

Long Duration Power Limit

Configure Package Power Limit 1 in watts. When the limit is exceeded, the CPU ratio will be lowered after a period of time. A lower limit can protect the CPU and save power, while a higher limit may improve performance.

Long Duration Maintained

Configure the period of time until the CPU ratio is lowered when the Long Duration Power Limit is exceeded.

Short Duration Power Limit

Configure Package Power Limit 2 in watts. When the limit is exceeded, the CPU ratio will be lowered immediately. A lower limit can protect the CPU and save power, while a higher limit may improve performance.

Primary Plane Current Limit

Configure the current limit of the CPU under Turbo Mode in ampere. A lower limit can protect the CPU and save power, while a higher limit may improve performance.

GT Frequency

Configure the frequency of the integrated GPU.

GT Voltage Mode

Auto: For optimized settings.

Adaptive: Add voltage to the integrated GPU when the system is under heavy load.

Override: The voltage is fixed.

GT Adaptive Voltage

Configure the fixed voltage added to the integrated GPU.

GT Voltage Offset

Configure the voltage added to the integrated GPU when the system is under heavy load.

DRAM Timing Configuration

Load XMP Setting

Load XMP settings to overclock the DDR3 memory and perform beyond standard specifications.

DRAM Reference Clock

Select Auto for optimized settings.

DRAM Frequency

If [Auto] is selected, the motherboard will detect the memory module(s) inserted and assign the appropriate frequency automatically.

DRAM Configuration



DRAM Tweaker

Fine tune the DRAM settings by leaving marks in checkboxes. Click OK to confirm and apply your new settings.

CAS# Latency (tCL)

The time between sending a column address to the memory and the beginning of the data in response.

RAS# to CAS# Delay (trCD)

The number of clock cycles required between the opening of a row of memory and accessing columns within it.

Row Precharge Time (trP)

The number of clock cycles required between the issuing of the precharge command and opening the next row.

RAS# Active Time (tRAS)

The number of clock cycles required between a bank active command and issuing the precharge command.

Command Rate (CR)

The delay between when a memory chip is selected and when the first active command can be issued.

Write Recovery Time (tWR)

The amount of delay that must elapse after the completion of a valid write operation, before an active bank can be precharged.

Refresh Cycle Time (tRFC)

The number of clocks from a Refresh command until the first Activate command to the same rank.

RAS to RAS Delay (tRRD)

The number of clocks between two rows activated in different banks of the same rank.

Write to Read Delay (tWTR)

The number of clocks between the last valid write operation and the next read command to the same internal bank.

Read to Precharge (tRTP)

The number of clocks that are inserted between a read command to a row pre-charge command to the same rank.

Four Activate Window (tFAW)

The time window in which four activates are allowed the same rank.

CAS Write Latency (tCWL)

Configure CAS Write Latency.

tREFI

Configure refresh cycles at an average periodic interval.

tCKE

Configure the period of time the DDR3 initiates a minimum of one refresh command internally once it enters Self-Refresh mode.

tRDRD

Configure between module read to read delay.

tRDRDDR

Configure between module read to read delay from different ranks.

tRDRDDD

Use this to change DRAM tRWSR Auto/Manual settings. The default is [Auto].

tWRRD

Configure between module write to read delay.

tWRRDDR

Configure between module write to read delay from different ranks.

tWRRDDD

Use this to change DRAM tRRSR Auto/Manual settings. The default is [Auto].

Configure between module write to read delay from different DIMMs.

tWRWR

Configure between module write to write delay.

tWRWRDR

Configure between module write to write delay from different ranks.

tWRWRDD

Configure between module write to write delay from different DIMMs.

tRDWR

Configure between module read to write delay.

tRDWRDR

Configure between module read to write delay from different ranks.

tRDWRDD

Configure between module read to write delay from different DIMMs.

RTL (CHA)

Configure round trip latency for channel A.

RTL (CHB)

Configure round trip latency for channel B.

IO-L (CHA)

Configure IO latency for channel A.

IO-L (CHB)

Configure IO latency for channel B.

ODT WR (CHA)

Configure the memory on die termination resistors' WR for channel A.

ODT WR (CHB)

Configure the memory on die termination resistors' WR for channel B.

ODT NOM (CHA)

Use this to change ODT (CHA) Auto/Manual settings. The default is [Auto].

ODT NOM (CHB)

Use this to change ODT (CHB) Auto/Manual settings. The default is [Auto].

Command Tri State

Enable for DRAM power saving.

MRC Fast Boot

Enable Memory Fast Boot to skip DRAM memory training for booting faster.

FIVR Configuration

FIVR Switch Frequency Signature

Select whether to boost or lower the FIVR Switch Frequency.

FIVR Switch Frequency Offset

Configure the percentage of frequency boost or deduction.

CPU Voltage Mode

Auto: For optimized settings.

Adaptive: Add voltage to the CPU when the system is under heavy load.

Override: The voltage is fixed.

CPU Override Voltage

Configure the voltage added to the CPU when the system is under heavy load.

CPU Voltage Offset

Configure the dynamic CPU voltage added to the CPU.

CPU Cache Override Voltage

Add voltage to the CPU Cache when the system is under heavy load.

CPU Cache Adaptive Voltage

Configure the voltage added to the CPU Cache when the system is under heavy load.

CPU Cache Voltage Offset

Configure the voltage for the CPU Cache. Setting the voltage higher may increase system stability when overclocking.

System Agent Voltage Offset

Configure the voltage for the System Agent. Setting the voltage higher may increase system stability when overclocking.

CPU Analog IO Voltage Offset

CPU I/O Analog Voltage.

CPU Digital IO Voltage Offset

CPU I/O Digital Voltage.

CPU Integrated VR Faults

Disable FIVR Faults to raise the threshold to trigger CPU over current protection and over voltage protection for better overclocking capabilities.

CPU Integrated VR Efficiency Mode

Enable FIVR Efficiency Management for power saving. Disable for better performance and overclocking capabilities.

Voltage Configuration

CPU Input Voltage

Configure the voltage for the CPU.

CPU Load-Line Calibration

CPU Load-Line Calibration helps prevent CPU voltage droop when the system is under heavy load.

VCORE External Offset

The fixed external voltage input to the CPU.

DRAM Voltage

Use this to configure DRAM Voltage. The default value is [Auto].

PCH 1.05V Voltage

Chipset 1.05V Voltage. Use default settings for best performance.

PCH 1.5V Voltage

I/O 1.5V Voltage. Use default settings for best performance.

4.4 Advanced Screen

In this section, you may set the configurations for the following items: CPU Configuration, Chipset Configuration, Storage Configuration, Intel® Rapid Start Technology, Intel® Smart Connect Technology, Super IO Configuration, ACPI Configuration and USB Configuration.



Setting wrong values in this section may cause the system to malfunction.

4.4.1 CPU Configuration



Active Processor Cores

Select the number of cores to enable in each processor package.

CPU C States Support

Enable CPU C States Support for power saving. It is recommended to keep C3, C6 and C7 all enabled for better power saving.

Enhanced Halt State (C1E)

Enable Enhanced Halt State (C1E) for lower power consumption.

CPU C3 State Support

Enable C3 sleep state for lower power consumption.

CPU C6 State Support

Enable C6 deep sleep state for lower power consumption.

CPU C7 State Support

Enable C7 deep sleep state for lower power consumption.

Package C State Support

Enable CPU, PCIe, Memory, Graphics C State Support for power saving.

CPU Thermal Throttling

Enable CPU internal thermal control mechanisms to keep the CPU from overheating.

No-Execute Memory Protection

Processors with No-Execution Memory Protection Technology may prevent certain classes of malicious buffer overflow attacks.

Intel Virtualization Technology

Intel Virtualization Technology allows a platform to run multiple operating systems and applications in independent partitions, so that one computer system can function as multiple virtual systems.

Hardware Prefetcher

Automatically prefetch data and code for the processor. Enable for better performance.

Adjacent Cache Line Prefetch

Automatically prefetch the subsequent cache line while retrieving the currently requested cache line. Enable for better performance.

4.4.2 Chipset Configuration



Primary Graphics Adapter

Select a primary VGA.

VT-d

Intel® Virtualization Technology for Directed I/O helps your virtual machine monitor better utilize hardware by improving application compatibility and reliability, and providing additional levels of manageability, security, isolation, and I/O performance.

PCIE2 Link Speed

Select the link speed for PCIE2.

PCIE3 Link Speed

Select the link speed for PCIE3.

PCIE4 Link Speed

Select the link speed for PCIE4.

Share Memory

Configure the size of memory that is allocated to the integrated graphics processor when the system boots up.

IGPU Multi-Monitor

Select disable to disable the integrated graphics when an external graphics card is installed. Select enable to keep the integrated graphics enabled at all times.

Render Standby

Power down the render unit when the GPU is idle for lower power consumption.

Onboard HD Audio

Enable/disable onboard HD audio. Set to Auto to enable onboard HD audio and automatically disable it when a sound card is installed.

Front Panel

Enable/disable front panel HD audio.

Onboard HDMI HD Audio

Enable audio for the onboard digital outputs.

Onboard LAN1

Enable or disable the onboard network interface controller.

Onboard LAN2

Enable or disable the onboard network interface controller.

Deep Sleep

Configure deep sleep mode for power saving when the computer is shut down.

Restore on AC/Power Loss

Select the power state after a power failure. If [Power Off] is selected, the power will remain off when the power recovers. If [Power On] is selected, the system will start to boot up when the power recovers.

Good Night LED

By enabling Good Night LED, the Power/HDD LEDs will be switched off when the system is on. It will also automatically switch off the Power and Keyboard LEDs when the system enters into Standby/Hibernation mode.

Onboard Debug Port LED

Enable/disable the onboard Dr. Debug LED.

4.4.3 Storage Configuration



SATA Controller(s)

Enable/disable the SATA controllers.

SATA Mode Selection

IDE: For better compatibility.

AHCI: Supports new features that improve performance.

RAID: Combine multiple disk drives into a logical unit.



AHCI (Advanced Host Controller Interface) supports NCQ and other new features that will improve SATA disk performance but IDE mode does not have these advantages.

SATA Aggressive Link Power Management

SATA Aggressive Link Power Management allows SATA devices to enter a low power state during periods of inactivity to save power. It is only supported by AHCI mode.

Hard Disk S.M.A.R.T.

S.M.A.R.T stands for Self-Monitoring, Analysis, and Reporting Technology. It is a monitoring system for computer hard disk drives to detect and report on various indicators of reliability.

ASMedia SATA3 Mode

IDE: For better compatibility.

AHCI: Supports new features that improve performance.

SATA Boot ROM

Enable to load ASMedia option ROM for better compatibility. Disable for faster boot time.

4.4.4 Intel® Rapid Start Technology



Intel® Rapid Start Technology

Intel® Rapid Start Technology is a new zero power hibernation mode which allows users to resume in just 5-6 seconds.

4.4.5 Intel® Smart Connect Technology



Intel® Smart Connect Technology

Intel® Smart Connect Technology automatically updates your email and social networks, such as Twitter, Facebook, etc. while the computer is in sleep mode.

4.4.6 Super IO Configuration



Serial Port

Enable or disable the Serial port.

Serial Port Address

Select the address of the Serial port.

Infrared Port

Enable or disable the Infrared port.

4.4.7 ACPI Configuration



Suspend to RAM

Select disable for ACPI suspend type S1. It is recommended to select auto for ACPI S3 power saving.

Check Ready Bit

Enable to enter the operating system after S3 only when the hard disk is ready, this is recommended for better system stability.

ACPI HPET Table

Enable the High Precision Event Timer for better performance and to pass WHQL tests.

PS/2 Keyboard Power On

Allow the system to be waked up by a PS/2 Keyboard.

PCI Devices Power On

Allow the system to be waked up by a PCI device and enable wake on LAN.

Wake From Onboard LAN

Allow the system to be waked up by the Onboard Intel I217V LAN.

Ring-In Power On

Allow the system to be waked up by onboard COM port modem Ring-In signals.

RTC Alarm Power On

Allow the system to be waked up by the real time clock alarm. Set it to By OS to let it be handled by your operating system.

USB Keyboard/Remote Power On

Allow the system to be waked up by an USB keyboard or remote controller.

USB Mouse Power On

Allow the system to be waked up by an USB mouse.

4.4.8 USB Configuration



USB Controller

Enable or disable all the USB ports.

USB 3.0 Controller

Enable or disable all the USB 3.0 ports.

Legacy USB Support

Enable or disable Legacy OS Support for USB 2.0 devices. If you encounter USB compatibility issues it is recommended to disable legacy USB support. Select UEFI Setup Only to support USB devices under the UEFI setup and Windows/Linux operating systems only.

Legacy USB 3.0 Support

Enable or disable Legacy OS Support for USB 3.0 devices.

4.5 Tools



System Browser

ASRock System Browser shows the overview of your current PC and the devices connected.

OMG (Online Management Guard)

Administrators are able to establish an internet curfew or restrict internet access at specified times via OMG. You may schedule the starting and ending hours of internet access granted to other users. In order to prevent users from bypassing OMG, guest accounts without permission to modify the system time are required.

UEFI Tech Service

Contact ASRock Tech Service if you are having trouble with your PC. Please setup network configuration before using UEFI Tech Service.

Easy RAID Installer

Easy RAID Installer helps you to copy the RAID driver from the support CD to your USB storage device. After copying the drivers please change the SATA mode to RAID, then you can start installing the operating system in RAID mode.

Easy Driver Installer

For users that don't have an optical disk drive to install the drivers from our support CD, Easy Driver Installer is a handy tool in the UEFI that installs the LAN driver to your system via an USB storage device, then downloads and installs the other required drivers automatically.

Instant Flash

Save UEFI files in your USB storage device and run Instant Flash to update your UEFI.

Secure Backup UEFI

Whenever one of the ROM images are corrupted or outdated, switch to the other flash ROM and execute Secure Backup UEFI to duplicate the current working ROM image to the secondary flash ROM.

Internet Flash

ASRock Internet Flash downloads and updates the latest UEFI firmware version from our servers for you. Please setup network configuration before using Internet Flash.

*For BIOS backup and recovery purpose, it is recommended to plug in your USB pen drive before using this function.

Network Configuration

Use this to configure internet connection settings for Internet Flash.



Internet Setting

Enable or disable sound effects in the setup utility.

UEFI Download Server

Select a server to download the UEFI firmware.

Dehumidifier Function

If Dehumidifier Function is enabled, the computer will power on automatically to dehumidify the system after entering S4/S5 state.

Dehumidifier Period

Configure the period of time until the computer powers on and enables Dehumidifier after entering S4/S5 state.

Dehumidifier Duration

Configure the duration of the dehumidifying process before it returns to S4/S5 state.

Dehumidifier CPU Fan Setting

Configure the speed of the CPU fan while Dehumidifier is enabled. The higher the value, the faster the fan speed.

Max: 255

Min: 1

Save User Default

Type a profile name and press enter to save your settings as user default.

Load User Default

Load previously saved user defaults.

4.6 Hardware Health Event Monitoring Screen

This section allows you to monitor the status of the hardware on your system, including the parameters of the CPU temperature, motherboard temperature, fan speed and voltage.



CPU Fan 1 & 2 Setting

Select a fan mode for CPU Fans 1&2, or choose Customize to set 5 CPU temperatures and assign a respective fan speed for each temperature.

Chassis Fan 1 Setting

Select a fan mode for Chassis Fan 1, or choose Customize to set 5 CPU temperatures and assign a respective fan speed for each temperature.

Chassis Fan 2 Setting

Select a fan mode for Chassis Fan 2.

Chassis Fan 3 Setting

Select a fan mode for Chassis Fan 3, or choose Customize to set 5 CPU temperatures and assign a respective fan speed for each temperature.

Over Temperature Protection

When Over Temperature Protection is enabled, the system automatically shuts down when the motherboard is overheated.

4.7 Boot Screen

This section displays the available devices on your system for you to configure the boot settings and the boot priority.



Fast Boot

Fast Boot minimizes your computer's boot time. In fast mode you may not boot from an USB storage device. Ultra Fast mode is only supported by Windows 8 and the VBIOS must support UEFI GOP if you are using an external graphics card. Please notice that Ultra Fast mode will boot so fast that the only way to enter this UEFI Setup Utility is to Clear CMOS or run the Restart to UEFI utility in Windows.

Boot From Onboard LAN

Allow the system to be waked up by the onboard LAN.

Setup Prompt Timeout

Configure the number of seconds to wait for the setup hot key.

Bootup Num-Lock

Select whether Num Lock should be turned on or off when the system boots up.

Boot Beep

Select whether the Boot Beep should be turned on or off when the system boots up. Please note that a buzzer is needed.

Full Screen Logo

Enable to display the boot logo or disable to show normal POST messages.

AddOn ROM Display

Enable AddOn ROM Display to see the AddOn ROM messages or configure the AddOn ROM if you've enabled Full Screen Logo. Disable for faster boot speed.

Boot Failure Guard

If the computer fails to boot for a number of times the system automatically restores the default settings.

Boot Failure Guard Count

Configure the number of attempts to boot until the system automatically restores the default settings.

CSM (Compatibility Support Module)



CSM

Enable to launch the Compatibility Support Module. Please do not disable unless you're running a WHCK test. If you are using Windows 8 64-bit and all of your devices support UEFI, you may also disable CSM for faster boot speed.

Launch PXE OpROM Policy

Select UEFI only to run those that support UEFI option ROM only. Select Legacy only to run those that support legacy option ROM only. Do not launch?

Launch Storage OpROM Policy

Select UEFI only to run those that support UEFI option ROM only. Select Legacy only to run those that support legacy option ROM only. Do not launch?

Launch Video OpROM Policy

Select UEFI only to run those that support UEFI option ROM only. Select Legacy only to run those that support legacy option ROM only. Do not launch?

4.8 Security Screen

In this section you may set or change the supervisor/user password for the system. You may also clear the user password.



Supervisor Password

Set or change the password for the administrator account. Only the administrator has authority to change the settings in the UEFI Setup Utility. Leave it blank and press enter to remove the password.

User Password

Set or change the password for the user account. Users are unable to change the settings in the UEFI Setup Utility. Leave it blank and press enter to remove the password.

Secure Boot

Enable to support Windows 8 Secure Boot.

4.9 Exit Screen



Save Changes and Exit

When you select this option the following message, “Save configuration changes and exit setup?” will pop out. Select [OK] to save changes and exit the UEFI SETUP UTILITY.

Discard Changes and Exit

When you select this option the following message, “Discard changes and exit setup?” will pop out. Select [OK] to exit the UEFI SETUP UTILITY without saving any changes.

Discard Changes

When you select this option the following message, “Discard changes?” will pop out. Select [OK] to discard all changes.

Load UEFI Defaults

Load UEFI default values for all options. The F9 key can be used for this operation.

Launch EFI Shell from filesystem device

Copy shellx64.efi to the root directory to launch EFI Shell.

Contact Information

If you need to contact ASRock or want to know more about ASRock, you're welcome to visit ASRock's website at <http://www.asrock.com>; or you may contact your dealer for further information. For technical questions, please submit a support request form at <http://www.asrock.com/support/tsd.asp>

ASRock Incorporation

2F., No.37, Sec. 2, Jhongyang S. Rd., Beitou District,

Taipei City 112, Taiwan (R.O.C.)

ASRock EUROPE B.V.

Bijsterhuizen 3151

6604 LV Wijchen

The Netherlands

Phone: +31-24-345-44-33

Fax: +31-24-345-44-38

ASRock America, Inc.

13848 Magnolia Ave, Chino, CA91710

U.S.A.

Phone: +1-909-590-8308

Fax: +1-909-590-1026