



# Z77 Extreme4

## User Manual

Version 1.2

Published June 2013

Copyright©2013 ASRock INC. All rights reserved.

---

## Copyright Notice:

No part of this manual may be reproduced, transcribed, transmitted, or translated in any language, in any form or by any means, except duplication of documentation by the purchaser for backup purpose, without written consent of ASRock Inc.

Products and corporate names appearing in this manual may or may not be registered trademarks or copyrights of their respective companies, and are used only for identification or explanation and to the owners' benefit, without intent to infringe.

## Disclaimer:

Specifications and information contained in this manual are furnished for informational use only and subject to change without notice, and should not be constructed as a commitment by ASRock. ASRock assumes no responsibility for any errors or omissions that may appear in this manual.

With respect to the contents of this manual, ASRock does not provide warranty of any kind, either expressed or implied, including but not limited to the implied warranties or conditions of merchantability or fitness for a particular purpose.

In no event shall ASRock, its directors, officers, employees, or agents be liable for any indirect, special, incidental, or consequential damages (including damages for loss of profits, loss of business, loss of data, interruption of business and the like), even if ASRock has been advised of the possibility of such damages arising from any defect or error in the manual or product.



This device complies with Part 15 of the FCC Rules. Operation is subject to the following two conditions:

- (1) this device may not cause harmful interference, and
- (2) this device must accept any interference received, including interference that may cause undesired operation.

## CALIFORNIA, USA ONLY

The Lithium battery adopted on this motherboard contains Perchlorate, a toxic substance controlled in Perchlorate Best Management Practices (BMP) regulations passed by the California Legislature. When you discard the Lithium battery in California, USA, please follow the related regulations in advance.

“Perchlorate Material-special handling may apply, see

[www.dtsc.ca.gov/hazardouswaste/perchlorate](http://www.dtsc.ca.gov/hazardouswaste/perchlorate)”

The terms HDMI™ and HDMI High-Definition Multimedia Interface, and the HDMI logo are trademarks or registered trademarks of HDMI Licensing LLC in the United States and other countries.



---

# Contents

<b>1 Introduction</b> .....	<b>7</b>
1.1 Package Contents .....	7
1.2 Specifications.....	8
1.3 Motherboard Layout.....	13
1.4 I/O Panel .....	14
<b>2 Installation</b> .....	<b>16</b>
2.1 Screw Holes.....	16
2.2 Pre-installation Precautions .....	16
2.3 CPU Installation .....	17
2.4 Installation of Heatsink and CPU fan .....	19
2.5 Installation of Memory Modules (DIMM).....	20
2.6 Expansion Slots (PCI and PCI Express Slots) .....	22
2.7 SLI™ and Quad SLI™ Operation Guide .....	23
2.8 CrossFireX™ and Quad CrossFireX™ Operation Guide .....	27
2.9 Dual Monitor and Surround Display Features.....	31
2.10 ASRock Smart Remote Installation Guide .....	34
2.11 Jumpers Setup .....	35
2.12 Onboard Headers and Connectors .....	36
2.13 Smart Switches .....	41
2.14 Dr. Debug .....	42
2.15 Serial ATA (SATA) / Serial ATA2 (SATA2) Hard Disks Installation .....	46
2.16 Serial ATA3 (SATA3) Hard Disks Installation .....	46
2.17 Hot Plug and Hot Swap Functions for SATA / SATA2 HDDs .....	47
2.18 Hot Plug and Hot Swap Functions for SATA3 HDDs .....	47
2.19 SATA / SATA2 / SATA3 HDD Hot Plug Feature and Operation Guide .....	48
2.20 Driver Installation Guide .....	50
2.21 Installing Windows® 7 / 7 64-bit / Vista™ / Vista™ 64-bit With RAID Functions .....	50
2.22 Installing Windows® 7 / 7 64-bit / Vista™ / Vista™ 64-bit / XP / XP 64-bit Without RAID Functions .....	51
2.22.1 Installing Windows® XP / XP 64-bit Without RAID Functions.....	51
2.22.2 Installing Windows® 7 / 7 64-bit / Vista™ / Vista™ 64-bit Without RAID Functions.....	51

---

<b>3 UEFI SETUP UTILITY .....</b>	<b>53</b>
3.1 Introduction .....	53
3.1.1 UEFI Menu Bar .....	53
3.1.2 Navigation Keys .....	54
3.2 Main Screen.....	54
3.3 OC Tweaker Screen .....	55
3.4 Advanced Screen.....	59
3.4.1 CPU Configuration .....	60
3.4.2 North Bridge Configuration.....	62
3.4.3 South Bridge Configuration.....	63
3.4.4 Storage Configuration .....	64
3.4.5 Intel(R) Rapid Start Technology .....	65
3.4.6 Intel(R) Smart Connect Technology .....	66
3.4.7 Super IO Configuration .....	67
3.4.8 ACPI Configuration.....	68
3.4.9 USB Configuration .....	69
3.5 Hardware Health Event Monitoring Screen .....	70
3.6 Boot Screen.....	71
3.7 Security Screen .....	72
3.8 Exit Screen .....	73
<b>4 Software Support.....</b>	<b>74</b>
4.1 Install Operating System.....	74
4.2 Support CD Information .....	74
4.2.1 Running Support CD.....	74
4.2.2 Drivers Menu.....	74
4.2.3 Utilities Menu.....	74
4.2.4 Contact Information.....	74

---

# Chapter 1: Introduction

Thank you for purchasing ASRock **Z77 Extreme4** motherboard, a reliable motherboard produced under ASRock's consistently stringent quality control. It delivers excellent performance with robust design conforming to ASRock's commitment to quality and endurance.

In this manual, chapter 1 and 2 contains introduction of the motherboard and step-by-step guide to the hardware installation. Chapter 3 and 4 contains the configuration guide to BIOS setup and information of the Support CD.



Because the motherboard specifications and the BIOS software might be updated, the content of this manual will be subject to change without notice. In case any modifications of this manual occur, the updated version will be available on ASRock website without further notice. You may find the latest VGA cards and CPU support lists on ASRock website as well.

ASRock website <http://www.asrock.com>

If you require technical support related to this motherboard, please visit our website for specific information about the model you are using.

[www.asrock.com/support/index.asp](http://www.asrock.com/support/index.asp)

## 1.1 Package Contents

ASRock **Z77 Extreme4** Motherboard

(ATX Form Factor: 12.0-in x 8.6-in, 30.5 cm x 21.8 cm)

ASRock **Z77 Extreme4** Quick Installation Guide

ASRock **Z77 Extreme4** Support CD

2 x Serial ATA (SATA) Data Cables (Optional)

1 x I/O Panel Shield

1 x ASRock SLI\_Bridge\_2S Card



### **ASRock Reminds You...**

To get better performance in Windows<sup>®</sup> 7 / 7 64-bit / Vista<sup>™</sup> / Vista<sup>™</sup> 64-bit, it is recommended to set the BIOS option in Storage Configuration to AHCI mode. For the BIOS setup, please refer to the "User Manual" in our support CD for details.

## 1.2 Specifications

<b>Platform</b>	<ul style="list-style-type: none"> <li>- ATX Form Factor: 12.0-in x 8.6-in, 30.5 cm x 21.8 cm</li> <li>- Premium Gold Capacitor design (100% Japan-made high-quality Conductive Polymer Capacitors)</li> </ul>
<b>CPU</b>	<ul style="list-style-type: none"> <li>- Supports 3<sup>rd</sup> and 2<sup>nd</sup> Generation Intel® Core™ i7 / i5 / i3 in LGA1155 Package</li> <li>- Digi Power Design</li> <li>- 8 + 4 Power Phase Design</li> <li>- Supports Intel® Turbo Boost 2.0 Technology</li> <li>- Supports Intel® K-Series unlocked CPU</li> <li>- Supports Hyper-Threading Technology (see <b>CAUTION 1</b>)</li> <li>- Supports Intel® Rapid Start Technology and Smart Connect Technology with Intel® Ivy Bridge CPU</li> </ul>
<b>Chipset</b>	<ul style="list-style-type: none"> <li>- Intel® Z77</li> </ul>
<b>Memory</b>	<ul style="list-style-type: none"> <li>- Dual Channel DDR3 Memory Technology (see <b>CAUTION 2</b>)</li> <li>- 4 x DDR3 DIMM slots</li> <li>- Supports DDR3 2800+(OC)/2400(OC)/2133(OC)/1866(OC)/1600/1333/1066 non-ECC, un-buffered memory</li> <li>- Max. capacity of system memory: 32GB (see <b>CAUTION 3</b>)</li> <li>- Supports Intel® Extreme Memory Profile (XMP)1.3/1.2</li> </ul>
<b>Expansion Slot</b>	<ul style="list-style-type: none"> <li>- 2 x PCI Express 3.0 x16 slots (PCIe2/PCIe3: single at x16 (PCIe2) / x8 (PCIe3) or dual at x8/x8 mode) (see <b>CAUTION 4</b>)</li> <li>* PCIe 3.0 is only supported with Intel® Ivy Bridge CPU. With Intel® Sandy Bridge CPU, it only supports PCIe 2.0.</li> <li>- 2 x PCI Express 2.0 x 1 slots</li> <li>- 2 x PCI slots</li> <li>- Supports AMD Quad CrossFireX™ and CrossFireX™</li> <li>- Supports NVIDIA® Quad SLI™ and SLI™</li> </ul>
<b>Graphics</b>	<ul style="list-style-type: none"> <li>* Intel® HD Graphics Built-in Visuals and the VGA outputs can be supported only with processors which are GPU integrated.</li> <li>- Supports Intel® HD Graphics Built-in Visuals: Intel® Quick Sync Video, Intel® InTru™ 3D, Intel® Clear Video HD Technology, Intel® Insider™, Intel® HD Graphics 2500/4000, Intel® Advanced Vector Extensions (AVX)</li> <li>- Pixel Shader 5.0, DirectX 11 with Intel® Ivy Bridge CPU. Pixel Shader 4.1, DirectX 10.1 with Intel® Sandy Bridge CPU.</li> <li>- Max. shared memory 1760MB (see <b>CAUTION 5</b>)</li> </ul>

	<ul style="list-style-type: none"> <li>- Three VGA Output options: D-Sub, DVI-D and HDMI (see <b>CAUTION 6</b>)</li> <li>- Supports HDMI 1.4a Technology with max. resolution up to 1920x1200 @ 60Hz</li> <li>- Supports DVI with max. resolution up to 1920x1200 @ 60Hz</li> <li>- Supports D-Sub with max. resolution up to 2048x1536 @ 75Hz</li> <li>- Supports Auto Lip Sync, Deep Color (12bpc), xvYCC and HBR (High Bit Rate Audio) with HDMI (Compliant HDMI monitor is required) (see <b>CAUTION 7</b>)</li> <li>- Supports HDCP function with DVI and HDMI ports</li> <li>- Supports Full HD 1080p Blu-ray (BD) / HD-DVD playback with DVI and HDMI ports</li> </ul>
<b>Audio</b>	<ul style="list-style-type: none"> <li>- 7.1 CH HD Audio with Content Protection (Realtek ALC898 Audio Codec)</li> <li>- Premium Blu-ray audio support</li> </ul>
<b>LAN</b>	<ul style="list-style-type: none"> <li>- PCIE x1 Gigabit LAN 10/100/1000 Mb/s</li> <li>- Broadcom BCM57781</li> <li>- Supports Wake-On-LAN</li> <li>- Supports Energy Efficient Ethernet 802.3az</li> <li>- Supports PXE</li> </ul>
<b>Rear Panel I/O</b>	<p>I/O Panel</p> <ul style="list-style-type: none"> <li>- 1 x PS/2 Keyboard/Mouse Port</li> <li>- 1 x D-Sub Port</li> <li>- 1 x DVI-D Port</li> <li>- 1 x HDMI Port</li> <li>- 1 x Optical SPDIF Out Port</li> <li>- 2 x Ready-to-Use USB 2.0 Ports</li> <li>- 1 x eSATA3 Connector</li> <li>- 4 x Ready-to-Use USB 3.0 Ports</li> <li>- 1 x RJ-45 LAN Port with LED (ACT/LINK LED and SPEED LED)</li> <li>- 1 x Clear CMOS Switch with LED</li> <li>- HD Audio Jack: Rear Speaker/Central/Bass/Line in/Front Speaker/Microphone (see <b>CAUTION 8</b>)</li> </ul>
<b>SATA3</b>	<ul style="list-style-type: none"> <li>- 2 x SATA3 6.0 Gb/s connectors by Intel® Z77, support RAID (RAID 0, RAID 1, RAID 5, RAID 10, Intel Rapid Storage and Intel Smart Response Technology), NCQ, AHCI and Hot Plug functions</li> </ul>

	<ul style="list-style-type: none"> <li>- 2 x SATA3 6.0 Gb/s connectors by ASMedia ASM1061, support NCQ, AHCI and “Hot Plug” functions (SATA3_A1 connector is shared with eSATA3 port)</li> </ul>
<b>USB3.0</b>	<ul style="list-style-type: none"> <li>- 2 x Rear USB 3.0 ports by Intel® Z77, support USB 1.0/2.0/3.0 up to 5Gb/s</li> <li>- 2 x Rear USB 3.0 ports by ASMedia ASM1042, support USB 1.0/2.0/3.0 up to 5Gb/s</li> <li>- 1 x Front USB 3.0 header by Intel® Z77 (supports 2 USB 3.0 ports), supports USB 1.0/2.0/3.0 up to 5Gb/s</li> </ul>
<b>Connector</b>	<ul style="list-style-type: none"> <li>- 4 x SATA2 3.0 Gb/s connectors, support RAID (RAID 0, RAID 1, RAID 5, RAID 10, Intel Rapid Storage and Intel Smart Response Technology), NCQ, AHCI and Hot Plug functions</li> <li>- 4 x SATA3 6.0Gb/s connectors</li> <li>- 1 x IR header</li> <li>- 1 x CIR header</li> <li>- 1 x COM port header</li> <li>- 1 x HDMI_SPDIF header</li> <li>- 1 x Power LED header</li> <li>- CPU/Chassis/Power FAN connector</li> <li>- 24 pin ATX power connector</li> <li>- 8 pin 12V power connector</li> <li>- Front panel audio connector</li> <li>- 3 x USB 2.0 headers (support 6 USB 2.0 ports)</li> <li>- 1 x USB 3.0 header (supports 2 USB 3.0 ports)</li> <li>- 1 x Dr. Debug with LED</li> </ul>
<b>Smart Switch</b>	<ul style="list-style-type: none"> <li>- 1 x Clear CMOS Switch with LED</li> <li>- 1 x Power Switch with LED</li> <li>- 1 x Reset Switch with LED</li> </ul>
<b>BIOS Feature</b>	<ul style="list-style-type: none"> <li>- 64Mb AMI UEFI Legal BIOS with GUI support</li> <li>- Supports “Plug and Play”</li> <li>- ACPI 1.1 Compliance Wake Up Events</li> <li>- Supports jumperfree</li> <li>- SMBIOS 2.3.1 Support</li> <li>- CPU Core, IGPU, DRAM, 1.8V PLL, VTT, VCCSA Voltage Multi-adjustment</li> </ul>
<b>Support CD</b>	<ul style="list-style-type: none"> <li>- Drivers, Utilities, AntiVirus Software (Trial Version), CyberLink MediaEspresso 6.5 Trial, ASRock MAGIX Multimedia Suite - OEM</li> </ul>
<b>Unique Feature</b>	<ul style="list-style-type: none"> <li>- ASRock Extreme Tuning Utility (AXTU) (see <b>CAUTION 9</b>)</li> <li>- ASRock Instant Boot</li> </ul>



	<ul style="list-style-type: none"> <li>- ASRock Instant Flash (see <b>CAUTION 10</b>)</li> <li>- ASRock APP Charger (see <b>CAUTION 11</b>)</li> <li>- ASRock SmartView (see <b>CAUTION 12</b>)</li> <li>- ASRock XFast USB (see <b>CAUTION 13</b>)</li> <li>- ASRock XFast LAN (see <b>CAUTION 14</b>)</li> <li>- ASRock XFast RAM (see <b>CAUTION 15</b>)</li> <li>- ASRock Crashless BIOS (see <b>CAUTION 16</b>)</li> <li>- Lucid Virtu Universal MVP (see <b>CAUTION 17</b>) <ul style="list-style-type: none"> <li>* Lucid Virtu Universal MVP can be supported only with processors which are GPU integrated.</li> </ul> </li> <li>- Hybrid Booster: <ul style="list-style-type: none"> <li>- CPU Frequency Stepless Control (see <b>CAUTION 18</b>)</li> <li>- ASRock U-COP (see <b>CAUTION 19</b>)</li> <li>- Boot Failure Guard (B.F.G.)</li> </ul> </li> <li>- Combo Cooler Option (C.C.O.) (see <b>CAUTION 20</b>)</li> <li>- Good Night LED</li> </ul>
<b>Hardware Monitor</b>	<ul style="list-style-type: none"> <li>- CPU Temperature Sensing</li> <li>- Chassis Temperature Sensing</li> <li>- CPU/Chassis/Power Fan Tachometer</li> <li>- CPU/Chassis Quiet Fan (Allows Chassis Fan Speed Auto-Adjust by CPU Temperature)</li> <li>- CPU/Chassis Fan Multi-Speed Control</li> <li>- Voltage Monitoring: +12V, +5V, +3.3V, CPU Vcore</li> </ul>
<b>OS</b>	<ul style="list-style-type: none"> <li>- Microsoft® Windows® 7 / 7 64-bit / Vista™ / Vista™ 64-bit / XP / XP 64-bit compliant (see <b>CAUTION 21</b>)</li> </ul>
<b>Certifications</b>	<ul style="list-style-type: none"> <li>- FCC, CE, WHQL</li> <li>- ErP/EuP Ready (ErP/EuP ready power supply is required) (see <b>CAUTION 22</b>)</li> </ul>

\* For detailed product information, please visit our website: <http://www.asrock.com>

#### **WARNING**

Please realize that there is a certain risk involved with overclocking, including adjusting the setting in the BIOS, applying Untied Overclocking Technology, or using third-party overclocking tools. Overclocking may affect your system's stability, or even cause damage to the components and devices of your system. It should be done at your own risk and expense. We are not responsible for possible damage caused by overclocking.

---

## **CAUTION!**

1. About the settings of "Hyper Threading Technology", please check page 60.
2. This motherboard supports Dual Channel Memory Technology. Before you implement Dual Channel Memory Technology, make sure to read the installation guide of memory modules on page 20 for proper installation.
3. Due to the operating system limitation, the actual memory size may be less than 4GB for the reservation for system usage under Windows® 7 / Vista™ / XP. For Windows® OS with 64-bit CPU, there is no such limitation. You can use ASRock XFast RAM to utilize the memory that Windows® cannot use.
4. Only PCIE2 and PCIE3 slots support Gen 3 speed. To run the PCI Express in Gen 3 speed, please install an Ivy Bridge CPU. If you install a Sandy Bridge CPU, the PCI Express will run only at PCI Express Gen 2 speed.
5. The maximum shared memory size is defined by the chipset vendor and is subject to change. Please check Intel® website for the latest information.
6. You can choose to use two of the three monitors only. D-Sub, DVI-D and HDMI monitors cannot be enabled at the same time. Besides, with the DVI-to-HDMI adapter, the DVI-D port can support the same features as HDMI port.
7. xvYCC and Deep Color are only supported under Windows® 7 64-bit / 7. Deep Color mode will be enabled only if the display supports 12bpc in EDID. HBR is supported under Windows® 7 64-bit / 7 / Vista™ 64-bit / Vista™.
8. For microphone input, this motherboard supports both stereo and mono modes. For audio output, this motherboard supports 2-channel, 4-channel, 6-channel, and 8-channel modes. Please check the table on page 14 for proper connection.
9. ASRock Extreme Tuning Utility (AXTU) is an all-in-one tool to re-tune different system functions in a user-friendly interface, which includes Hardware Monitor, Fan Control, Overclocking, OC DNA and IES. In Hardware Monitor, it shows the major readings of your system. In Fan Control, it shows the fan speed and temperature for you to adjust. In Overclocking, you are allowed to overclock CPU frequency for optimal system performance. In OC DNA, you can save your OC settings as a profile and share it with your friends. Your friends then can load the OC profile to their own system to get the same OC settings. In IES (Intelligent Energy Saver), the voltage regulator can reduce the number of output phases to improve efficiency when the CPU cores are idle without sacrificing computing performance. Please visit our website for the operation procedures of ASRock Extreme Tuning Utility (AXTU).  
ASRock website: <http://www.asrock.com>

- 
10. ASRock Instant Flash is a BIOS flash utility embedded in Flash ROM. This convenient BIOS update tool allows you to update system BIOS without entering operating systems first like MS-DOS or Windows®. With this utility, you can press the <F6> key during the POST or the <F2> key to enter into the BIOS setup menu to access ASRock Instant Flash. Just launch this tool and save the new BIOS file to your USB flash drive, floppy disk or hard drive, then you can update your BIOS only in a few clicks without preparing an additional floppy diskette or other complicated flash utility. Please be noted that the USB flash drive or hard drive must use FAT32/16/12 file system.
  11. If you desire a faster, less restricted way of charging your Apple devices, such as iPhone/iPad/iPod Touch, ASRock has prepared a wonderful solution for you - ASRock APP Charger. Simply install the APP Charger driver, it makes your iPhone charge much quickly from your computer and up to 40% faster than before. ASRock APP Charger allows you to quickly charge many Apple devices simultaneously and even supports continuous charging when your PC enters into Standby mode (S1), Suspend to RAM (S3), hibernation mode (S4) or power off (S5). With APP Charger driver installed, you can easily enjoy the marvelous charging experience.  
ASRock website: <http://www.asrock.com/Feature/AppCharger/index.asp>
  12. ASRock SmartView, a new function for internet browsers, is the smart start page for IE that combines your most visited web sites, your history, your Facebook friends and your real-time newsfeed into an enhanced view for a more personal Internet experience. ASRock motherboards are exclusively equipped with the ASRock SmartView utility that helps you keep in touch with friends on-the-go. To use ASRock SmartView feature, please make sure your OS version is Windows® 7 / 7 64 bit / Vista™ / Vista™ 64 bit, and your browser version is IE8.  
ASRock website: <http://www.asrock.com/Feature/SmartView/index.asp>
  13. ASRock XFast USB can boost USB storage device performance. The performance may depend on the properties of the device.
  14. ASRock XFast LAN provides a faster internet access, which includes the benefits listed below. LAN Application Prioritization: You can configure your application's priority ideally and/or add new programs. Lower Latency in Game: After setting online game's priority higher, it can lower the latency in games. Traffic Shaping: You can watch Youtube HD videos and download simultaneously. Real-Time Analysis of Your Data: With the status window, you can easily recognize which data streams you are transferring currently.

- 
15. ASRock XFast RAM is a new function that is included into ASRock Extreme Tuning Utility (AXTU). It fully utilizes the memory space that cannot be used under Windows® OS 32-bit CPU. ASRock XFast RAM shortens the loading time of previously visited websites, making web surfing faster than ever. And it also boosts the speed of Adobe Photoshop 5 times faster. Another advantage of ASRock XFast RAM is that it reduces the frequency of accessing your SSDs or HDDs in order to extend their lifespan.
  16. ASRock Crashless BIOS allows users to update their BIOS without fear of failing. If power loss occurs during the BIOS update process, ASRock Crashless BIOS will automatically finish the BIOS update procedure after regaining power. Please note that BIOS files need to be placed in the root directory of your USB disk. Only USB2.0 ports support this feature.
  17. VIRTU Universal MVP includes the base features of Virtu Universal technology, which virtualizes integrated GPU and discrete GPU for best of breed functionality. It also features Virtual Vsync™ for no-compromise visual quality. With the added benefits of HyperFormance technology, VIRTU Universal MVP improves game performance by intelligently reducing redundant rendering tasks in the flow between the CPU, GPU and the display.
  18. Although this motherboard offers stepless control, it is not recommended to perform over-clocking. Frequencies other than the recommended CPU bus frequencies may cause instability of the system or damage the CPU.
  19. While CPU overheat is detected, the system will automatically shutdown. Before you resume the system, please check if the CPU fan on the motherboard functions properly and unplug the power cord, then plug it back again. To improve heat dissipation, remember to spray thermal grease between the CPU and the heatsink when you install the PC system.
  20. Combo Cooler Option (C.C.O.) provides the flexible option to adopt three different CPU cooler types, Socket LGA 775, LGA 1155 and LGA 1156. Please be noticed that not all the 775 and 1156 CPU Fan can be used.
  21. ASRock XFast RAM is not supported by Microsoft® Windows® XP / XP 64-bit. Intel® Smart Connect Technology and Intel® USB 3.0 ports are not supported by Microsoft® Windows® Vista™ / Vista™ 64-bit / XP / XP 64-bit.
  22. EuP stands for Energy Using Product, was a provision regulated by the European Union to define the power consumption for the completed system. According to EuP, the total AC power of the completed system should be under 1.00W in off mode condition. To meet EuP standards, an EuP ready motherboard and an EuP ready power supply are required. According to Intel's suggestion, the EuP ready power supply must meet the standard of 5v, and the standby power efficiency should be higher than 50% under 100 mA current consumption. For EuP ready power supply selection, we recommend you to check with the power supply manufacturer for more details.

## 1.3 Motherboard Layout

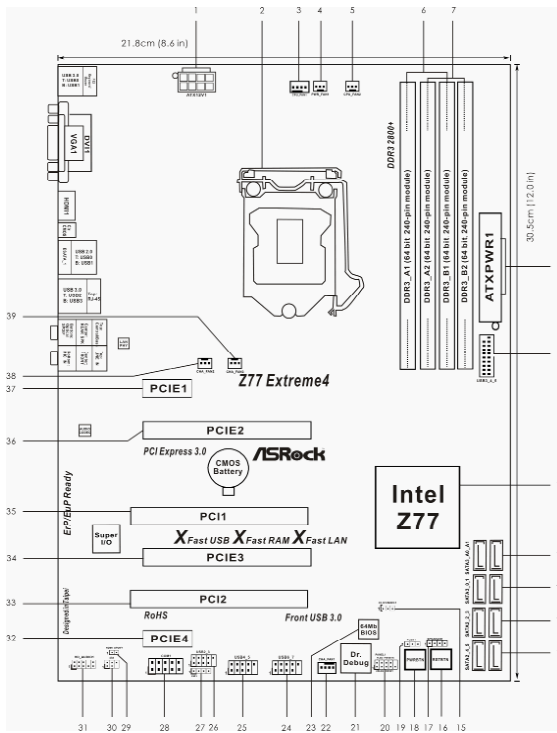

- |    |   |    |  |
|----|---|----|--|
| 1  | ATX 12V Power Connector (ATX12V1)                     | 21 | Dr. Debug                                    |
| 2  | 1155-Pin CPU Socket                                   | 22 | Chassis Fan Connector (CHA_FAN1)             |
| 3  | CPU Fan Connector (CPU_FAN1)                          | 23 | SPI Flash Memory (64Mb)                      |
| 4  | Power Fan Connector (PWR_FAN1)                        | 24 | USB 2.0 Header (USB6_7, Black)               |
| 5  | CPU Fan Connector (CPU_FAN2)                          | 25 | USB 2.0 Header (USB4_5, Black)               |
| 6  | 2 x 240-pin DDR3 DIMM Slots (DDR3_A1, DDR3_B1, Black) | 26 | USB 2.0 Header (USB2_3, Black)               |
| 7  | 2 x 240-pin DDR3 DIMM Slots (DDR3_A2, DDR3_B2, Black) | 27 | Consumer Infrared Module Header (CIR1, Gray) |
| 8  | ATX Power Connector (ATXPWR1)                         | 28 | COM Port Header (COM1)                       |
| 9  | USB 3.0 Header (USB3_4_5, Black)                      | 29 | HDMI_SPDIF Header (HDMI_SPDIF1, Black)       |
| 10 | Intel Z77 Chipset                                     | 30 | Infrared Module Header (IR1)                 |
| 11 | SATA3 Connectors (SATA3_A0_A1, Gray)                  | 31 | Front Panel Audio Header (HD_AUDIO1, Black)  |
| 12 | SATA3 Connectors (SATA3_0_1, Gray)                    | 32 | PCI Express 2.0 x1 Slot (PCIE4, Black)       |
| 13 | SATA2 Connectors (SATA2_2_3, Black)                   | 33 | PCI Slot (PCIE2, Black)                      |
| 14 | SATA2 Connectors (SATA2_4_5, Black)                   | 34 | PCI Express 3.0 x16 Slot (PCIE3, Black)      |
| 15 | Clear CMOS Jumper (CLRCMOS1)                          | 35 | PCI Slot (PCIE1, Black)                      |
| 16 | Reset Switch (RSTBTN)                                 | 36 | PCI Express 3.0 x16 Slot (PCIE2, Black)      |
| 17 | Chassis Speaker Header (SPEAKER1, Black)              | 37 | PCI Express 2.0 x1 Slot (PCIE1, Black)       |
| 18 | Power Switch (PWRBTN)                                 | 38 | Chassis Fan Connector (CHA_FAN2)             |
| 19 | Power LED Header (PLED1)                              | 39 | Chassis Fan Connector (CHA_FAN3)             |
| 20 | System Panel Header (PANEL1, Black)                   |    |  |

## 1.4 I/O Panel

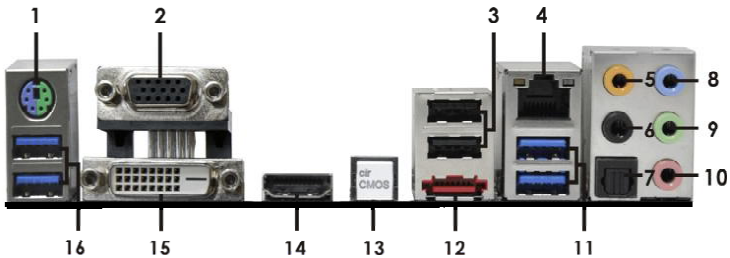

- |   |                                |
|---|--------------------------------|
| 1 PS/2 Keyboard/Mouse Port (Purple/Green) | ** 9 Front Speaker (Lime)      |
| 2 D-Sub Port (VGA1)                       | 10 Microphone (Pink)           |
| 3 USB 2.0 Ports (USB01)                   | 11 USB 3.0 Ports (USB3_2_3)    |
| * 4 LAN RJ-45 Port                        | *** 12 eSATA3 Port (ESATA_1)   |
| 5 Central / Bass (Orange)                 | 13 Clear CMOS Switch (CLRCBTN) |
| 6 Rear Speaker (Black)                    | 14 HDMI Port (HDMI1)           |
| 7 Optical SPDIF Out Port                  | 15 DVI-D Port (DVI1)           |
| 8 Line In (Light Blue)                    | 16 USB 3.0 Ports (USB3_01)     |

\* There are two LED next to the LAN port. Please refer to the table below for the LAN port LED indications.

### LAN Port LED Indications

Activity/Link LED	
Status	Description
Off	No Link
Blinking	Data Activity
On	Link

SPEED LED	
Status	Description
Off	10Mbps connection
Orange	100Mbps connection
Green	1Gbps connection

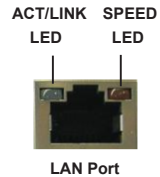

\*\* If you use 2-channel speaker, please connect the speaker's plug into "Front Speaker Jack".  
See the table below for connection details in accordance with the type of speaker you use.

### TABLE for Audio Output Connection

Audio Output Channels	Front Speaker (No. 9)	Rear Speaker (No. 6)	Central / Bass (No. 5)	Line in (No. 8)
2	V	--	--	--
4	V	V	--	--
6	V	V	V	--
8	V	V	V	V

---

To enable Multi-Streaming function, you need to connect a front panel audio cable to the front panel audio header. After restarting your computer, you will find "Mixer" tool on your system. Please select "Mixer ToolBox" , click "Enable playback multi-streaming", and click "ok". Choose "2CH", "4CH", "6CH", or "8CH" and then you are allowed to select "Realtek HDA Primary output" to use Rear Speaker, Central/Bass, and Front Speaker, or select "Realtek HDA Audio 2nd output" to use front panel audio.

\*\*\* eSATA3 connector supports SATA Gen3 in cable 1M.

---

## Chapter 2: Installation

This is an ATX form factor (12.0" x 8.6", 30.5 x 21.8 cm) motherboard. Before you install the motherboard, study the configuration of your chassis to ensure that the motherboard fits into it.



Make sure to unplug the power cord before installing or removing the motherboard. Failure to do so may cause physical injuries to you and damages to motherboard components.

### 2.1 Screw Holes

Place screws into the holes indicated by circles to secure the motherboard to the chassis.



Do not over-tighten the screws! Doing so may damage the motherboard.

### 2.2 Pre-installation Precautions

Take note of the following precautions before you install motherboard components or change any motherboard settings.

1. Unplug the power cord from the wall socket before touching any components.
2. To avoid damaging the motherboard's components due to static electricity, NEVER place your motherboard directly on the carpet or the like. Also remember to use a grounded wrist strap or touch a safety grounded object before you handle the components.
3. Hold components by the edges and do not touch the ICs.
4. Whenever you uninstall any component, place it on a grounded anti-static pad or in the bag that comes with the component.
5. When placing screws into the screw holes to secure the motherboard to the chassis, please do not over-tighten the screws! Doing so may damage the motherboard.



Before you install or remove any component, ensure that the power is switched off or the power cord is detached from the power supply. Failure to do so may cause severe damage to the motherboard, peripherals, and/or components.



---

## 2.3 CPU Installation

In order to provide the LGA 1155 CPU sockets more protection and make the installation process easier, ASRock has added a new protection cover on top of the load plate to replace the former PnP caps that were under the load plate. For the installation of Intel® 1155-Pin CPUs with the new protection cover, please follow the steps below.

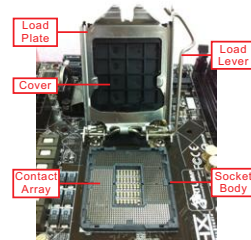

1155-Pin Socket Overview



Before you insert the 1155-Pin CPU into the socket, please check if the CPU surface is unclean or if there are any bent pins in the socket. Do not force to insert the CPU into the socket if above situation is found. Otherwise, the CPU will be seriously damaged.

### Step 1. Open the socket:

Step 1-1. Disengage the lever by pressing it down and sliding it out of the hook. You do not have to remove the protection cover.



Step 1-2. Keep the lever positioned at about 135 degrees in order to flip up the load plate.



### Step 2. Insert the 1155-Pin CPU:

Step 2-1. Hold the CPU by the edge which is marked with a black line.

Step 2-2. Orient the CPU with the IHS (Integrated Heat Sink) up. Locate Pin1 and the two orientation key notches.



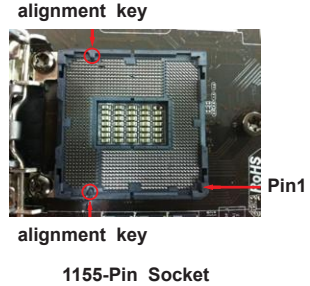
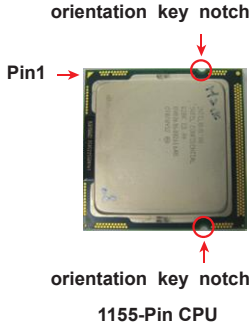

For proper installation, please ensure to match the two orientation key notches of the CPU with the two alignment keys of the socket.

Step 2-3. Carefully place the CPU into the socket.

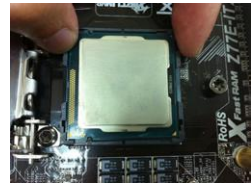

Step 2-4. Verify that the CPU is within the socket and properly mated to the orientation keys.

Step 3. Close the socket:

Step 3-1. Flip the load plate onto the IHS.



Step 3-2. Press down the load lever, and secure it with the load plate tab under the retention tab. The protection cover will automatically come off by itself.



Please save and replace the cover if the processor is removed. The cover must be placed if you wish to return the motherboard for after service.

## 2.4 Installation of CPU Fan and Heatsink

This motherboard is equipped with 1155-Pin socket that supports Intel 1155-Pin CPUs. Please adopt the type of heatsink and cooling fan compliant with Intel 1155-Pin CPU to dissipate heat. Before you install the heatsink, you need to spray thermal interface material between the CPU and the heatsink to improve heat dissipation. Ensure that the CPU and the heatsink are securely fastened and in good contact with each other. Then connect the CPU fan to the CPU\_FAN connector (CPU\_FAN1, see page 13, No. 3 or CPU\_FAN2, see page 13. No. 5).

**For proper installation, please kindly refer to the instruction manuals of your CPU fan and heatsink.**

Below is an example to illustrate the installation of the heatsink for 1155-Pin CPUs.

Step 1. Apply thermal interface material onto the center of the IHS on the socket's surface.



Step 2. Place the heatsink onto the socket. Ensure that the fan cables are oriented on side closest to the CPU fan connector on the motherboard (CPU\_FAN1, see page 13, No. 3 or CPU\_FAN2, see page 13. No. 5).

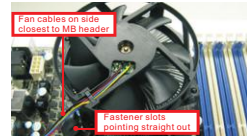

Step 3. Align fasteners with the motherboard through-holes.

Step 4. Rotate the fastener clockwise, then press down on fastener caps with thumb to install and lock. Repeat with remaining fasteners.



If you press down the fasteners without rotating them clockwise, the heatsink cannot be secured on the motherboard.

Step 5. Connect fan header with the CPU fan connector on the motherboard.

Step 6. Secure redundant cable with tie-wrap to ensure the cable does not interfere with fan operation or contact other components.



Please be noticed that this motherboard supports Combo Cooler Option (C.C.O.), which provides flexible options to adopt three different CPU cooler types, Socket LGA 775, LGA 1155 and LGA 1156. The white throughholes are for Socket LGA 1155/1156 CPU fan.



---

## 2.5 Installation of Memory Modules (DIMM)

This motherboard provides four 240-pin DDR3 (Double Data Rate 3) DIMM slots, and supports Dual Channel Memory Technology. For dual channel configuration, you always need to install **identical** (the same brand, speed, size and chip-type) DDR3 DIMM pair in the slots: You have to install **identical** DDR3 DIMMs in **Dual Channel A** (DDR3\_A1 and DDR3\_B1; Black slots; see p.13 No. 6) or **identical** DDR3 DIMMs in **Dual Channel B** (DDR3\_A2 and DDR3\_B2; Black slots; see p.13 No. 7), so that Dual Channel Memory Technology can be activated. This motherboard also allows you to install four DDR3 DIMMs for dual channel configuration, please install **identical** DDR3 DIMMs in all four slots. You may refer to the Dual Channel Memory Configuration Table below.

### Dual Channel Memory Configuration

	DDR3_A1 (Black Slot)	DDR3_A2 (Black Slot)	DDR3_B1 (Black Slot)	DDR3_B2 (Black Slot)
(1)	Populated	-	Populated	-
(2)	-	Populated	-	Populated
(3)*	Populated	Populated	Populated	Populated

- \* For configuration (3), please install **identical** DDR3 DIMMs in all four slots.



1. If you want to install two memory modules, for optimal compatibility and reliability, it is recommended to install them in the slots: DDR3\_A1 and DDR3\_B1, or DDR3\_A2 and DDR3\_B2.
2. If only one memory module or three memory modules are installed in the DDR3 DIMM slots on this motherboard, it is unable to activate Dual Channel Memory Technology.
3. If a pair of memory modules is NOT installed in the same Dual Channel, for example, installing a pair of memory modules in DDR3\_A1 and DDR3\_A2, it is unable to activate Dual Channel Memory Technology.
4. It is not allowed to install a DDR or DDR2 memory module into DDR3 slot; otherwise, this motherboard and DIMM may be damaged.
5. Some DDR3 1GB double-sided DIMMs with 16 chips may not work on this motherboard. It is not recommended to install them on this motherboard.
6. For optimal compatibility and stability while overclocking memory frequency, it is recommended to install one memory module on DDR3\_B2 slot or two memory modules on DDR3\_A2 and DDR3\_B2 slots.

---

## Installing a DIMM



Please make sure to disconnect power supply before adding or removing DIMMs or the system components.

- Step 1. Unlock a DIMM slot by pressing the retaining clips outward.
- Step 2. Align a DIMM on the slot such that the notch on the DIMM matches the break on the slot.

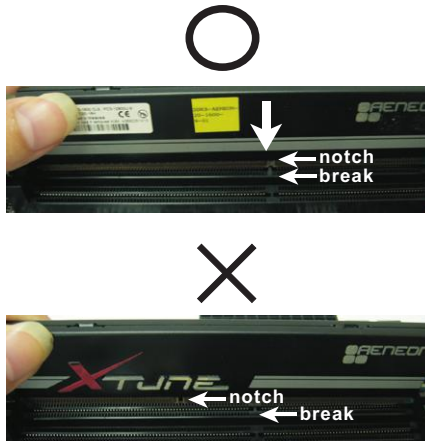

The DIMM only fits in one correct orientation. It will cause permanent damage to the motherboard and the DIMM if you force the DIMM into the slot at incorrect orientation.

- Step 3. Firmly insert the DIMM into the slot until the retaining clips at both ends fully snap back in place and the DIMM is properly seated.

---

## 2.6 Expansion Slots (PCI and PCI Express Slots)

There are 2 PCI slots and 4 PCI Express slots on this motherboard.

**PCI slots:** PCI slots are used to install expansion cards that have the 32-bit PCI interface.

**PCIe slots:** PCIe1 (PCIe 2.0 x1 slot) is used for a PCI Express x1 lane width card, such as a Gigabit LAN card, SATA2 card or ASRock Game Blaster, etc. PCIe4 (PCIe 2.0 x1 slot) is used for a PCI Express x1 lane width card, such as a Gigabit LAN card, SATA2 card, etc.

PCIe2 (PCIe 3.0 x16 slot) is used for PCI Express x16 lane width graphics cards, or to install PCI Express graphics cards to support CrossFireX™ or SLI™ function.

PCIe3 (PCIe 3.0 x16 slot) is used for PCI Express x8 lane width graphics cards, or to install PCI Express graphics cards to support CrossFireX™ or SLI™ function.



1. In single VGA card mode, it is recommended to install a PCI Express x16 graphics card on PCIe2 slot.
2. In CrossFireX™ mode or SLI™ mode, please install the PCI Express x16 graphics cards on PCIe2 and PCIe3 slots. Therefore, both these two slots will work at x8 bandwidth.
3. Please connect a chassis fan to the motherboard's chassis fan connector (CHA\_FAN1, CHA\_FAN2 or CHA\_FAN3) when using multiple graphics cards for better thermal environment.
4. Only PCIe2 and PCIe3 slots support Gen 3 speed. To run the PCI Express in Gen 3 speed, please install an Ivy Bridge CPU. If you install a Sandy Bridge CPU, the PCI Express will run only at PCI Express Gen 2 speed.

### Installing an expansion card

- Step 1. Before installing an expansion card, please make sure that the power supply is switched off or the power cord is unplugged. Please read the documentation of the expansion card and make necessary hardware settings for the card before you start the installation.
- Step 2. Remove the system unit cover (if your motherboard is already installed in a chassis).
- Step 3. Remove the bracket facing the slot that you intend to use. Keep the screws for later use.
- Step 4. Align the card connector with the slot and press firmly until the card is completely seated on the slot.
- Step 5. Fasten the card to the chassis with screws.
- Step 6. Replace the system cover.

---

## 2.7 SLI™ and Quad SLI™ Operation Guide

This motherboard supports NVIDIA® SLI™ and Quad SLI™ (Scalable Link Interface) technology that allows you to install up to two identical PCI Express x16 graphics cards. Currently, NVIDIA® SLI™ technology supports Windows® XP / XP 64-bit / Vista™ / Vista™ 64-bit / 7 / 7 64-bit OS. NVIDIA® Quad SLI™ technology support Windows® Vista™ / Vista™ 64-bit / 7 / 7 64-bit OS only. Please follow the installation procedures in this section.



### Requirements

1. For SLI™ technology, you should have two identical SLI™-ready graphics cards that are NVIDIA® certified. For Quad SLI™ technology, you should have two identical Quad SLI™-ready graphics cards (dual-GPU on each graphics card) that are NVIDIA® certified.
2. Make sure that your graphics card driver supports NVIDIA® SLI™ technology. Download the driver from NVIDIA® website ([www.nvidia.com](http://www.nvidia.com)).
3. Make sure that your power supply unit (PSU) can provide at least the minimum power required by your system. It is recommended to use NVIDIA® certified PSU. Please refer to NVIDIA® website for details.

## 2.7.1 Graphics Card Setup

### 2.7.1.1 Installing Two SLI™-Ready Graphics Cards

- Step 1. Install the identical SLI™-ready graphics cards that are NVIDIA® certified because different types of graphics cards will not work together properly. (Even the GPU chips version shall be the same.) Insert one graphics card into PCIE2 slot and the other graphics card to PCIE3 slot. Make sure that the cards are properly seated on the slots.



- Step2. If required, connect the auxiliary power source to the PCI Express graphics cards.

---

Step3. Align and insert the ASRock SLI\_Bridge\_2S Card to the goldfingers on each graphics card. Make sure the ASRock SLI\_Bridge\_2S Card is firmly in place.



ASRock SLI\_Bridge\_2S Card



Step4. Connect a VGA cable or a DVI cable to the monitor connector or the DVI connector of the graphics card that is inserted to PCIE2 slot.



---

## 2.7.2 Driver Installation and Setup

Install the graphics card drivers to your system. After that, you can enable the Multi-Graphics Processing Unit (GPU) feature in the NVIDIA® nView system tray utility. Please follow the below procedures to enable the multi-GPU feature.

### For Windows® XP / XP 64-bit OS: (For SLI™ mode only)

A. Double-click **NVIDIA Settings** icon on your Windows® taskbar.



B. From the pop-up menu, select **Set SLI and PhysX configuration**. In **Set PhysX GPU acceleration** item, please select **Enabled**. In **Select an SLI configuration** item, please select **Enable SLI**. And click **Apply**.

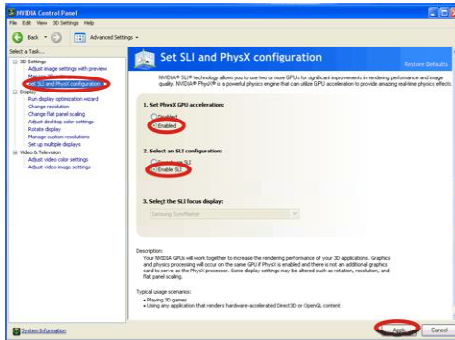

C. Reboot your system.

D. You can freely enjoy the benefit of SLI™ feature.

**For Windows® Vista™ / Vista™ 64-bit / 7 / 7 64-bit OS:  
(For SLI™ and Quad SLI™ mode)**

- A. Click the **Start** icon on your Windows taskbar.
- B. From the pop-up menu, select **All Programs**, and then click **NVIDIA Corporation**.
- C. Select **NVIDIA Control Panel** tab.
- D. Select **Control Panel** tab.

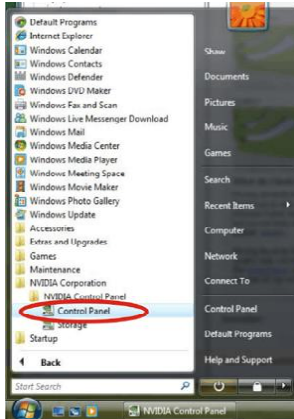

- E. From the pop-up menu, select **Set SLI and PhysX configuration**. In **Set PhysX GPU acceleration** item, please select **Enabled**. In **Select an SLI configuration** item, please select **Enable SLI**. And click **Apply**.

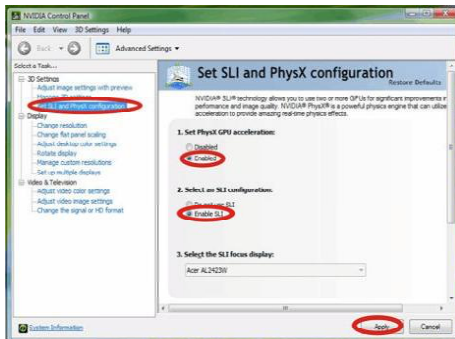

- F. Reboot your system.
- G. You can freely enjoy the benefit of SLI™ or Quad SLI™ feature.

\* SLI™ appearing here is a registered trademark of NVIDIA® Technologies Inc., and is used only for identification or explanation and to the owners' benefit, without intent to infringe.

---

## 2.8 CrossFireX™ and Quad CrossFireX™ Operation Guide

This motherboard supports CrossFireX™ and Quad CrossFireX™ feature. CrossFireX™ technology offers the most advantageous means available of combining multiple high performance Graphics Processing Units (GPU) in a single PC. Combining a range of different operating modes with intelligent software design and an innovative interconnect mechanism, CrossFireX™ enables the highest possible level of performance and image quality in any 3D application. Currently CrossFireX™ feature is supported with Windows® XP with Service Pack 2 / Vista™ / 7 OS. Quad CrossFireX™ feature is supported with Windows® Vista™ / 7 OS only. Please check AMD website for ATI™ CrossFireX™ driver updates.



1. If a customer incorrectly configures their system they will not see the performance benefits of CrossFireX™. All three CrossFireX™ components, a CrossFireX™ Ready graphics card, a CrossFireX™ Ready motherboard and a CrossFireX™ Edition co-processor graphics card, must be installed correctly to benefit from the CrossFireX™ multi-GPU platform.
2. If you pair a 12-pipe CrossFireX™ Edition card with a 16-pipe card, both cards will operate as 12-pipe cards while in CrossFireX™ mode.

### 2.8.1 Installing Two CrossFireX™-Ready Graphics Cards



Different CrossFireX™ cards may require different methods to enable CrossFireX™ feature. For other CrossFireX™ cards that AMD has released or will release in the future, please refer to AMD graphics card manuals for detailed installation guide.

- Step 1. Insert one Radeon graphics card into PCIE2 slot and the other Radeon graphics card to PCIE3 slot. Make sure that the cards are properly seated on the slots.



---

Step 2. Connect two Radeon graphics cards by installing CrossFire Bridge on CrossFire Bridge Interconnects on the top of Radeon graphics cards. (CrossFire Bridge is provided with the graphics card you purchase, not bundled with this motherboard. Please refer to your graphics card vendor for details.)



**CrossFire Bridge**



or

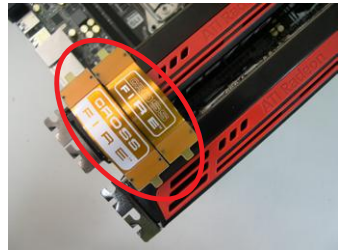

Step 3. Connect the DVI monitor cable to the DVI connector on the Radeon graphics card on PCIe2 slot. (You may use the DVI to D-Sub adapter to convert the DVI connector to D-Sub interface, and then connect the D-Sub monitor cable to the DVI to D-Sub adapter.)

---

## 2.8.2 Driver Installation and Setup

- Step 1. Power on your computer and boot into OS.
- Step 2. Remove the ATI™ driver if you have any VGA driver installed in your system.



The Catalyst Uninstaller is an optional download. We recommend using this utility to uninstall any previously installed Catalyst drivers prior to installation. Please check AMD website for ATI™ driver updates.

- Step 3. Install the required drivers to your system.

### For Windows® XP OS:

- A. ATI™ recommends Windows® XP Service Pack 2 or higher to be installed (If you have Windows® XP Service Pack 2 or higher installed in your system, there is no need to download it again):

<http://www.microsoft.com/windowsxp/sp2/default.mspx>

- B. You must have Microsoft .NET Framework installed prior to downloading and installing the CATALYST Control Center. Please check Microsoft website for details.

### For Windows® 7 / Vista™ OS:

Install the CATALYST Control Center. Please check AMD website for details.

- Step 4. Restart your computer.
- Step 5. Install the VGA card drivers to your system, and restart your computer. Then you will find “ATI Catalyst Control Center” on your Windows® taskbar.

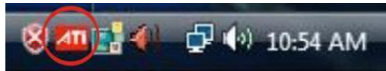

ATI Catalyst Control Center

- Step 6. Double-click “ATI Catalyst Control Center”. Click “View”, select “CrossFireX™”, and then check the item “Enable CrossFireX™”. Select “2 GPUs” and click “Apply”.





Although you have selected the option “Enable CrossFire™”, the CrossFire™ function may not work actually. Your computer will automatically reboot. After restarting your computer, please confirm whether the option “Enable CrossFire™” in “ATI Catalyst Control Center” is selected or not; if not, please select it again, and then you are able to enjoy the benefits of CrossFire™.

Step 7. You can freely enjoy the benefits of CrossFire™ or Quad CrossFire™.

\* CrossFire™ appearing here is a registered trademark of AMD Technologies Inc., and is used only for identification or explanation and to the owners' benefit, without intent to infringe.

\* For further information of AMD CrossFire™ technology, please check AMD's website for updates and details.

---

## 2.9 Dual Monitor and Surround Display Features

### Dual Monitor Feature

This motherboard supports dual monitor feature. With the internal VGA output support (DVI-D, D-Sub and HDMI), you can easily enjoy the benefits of dual monitor feature without installing any add-on VGA cards to this motherboard. This motherboard also provides independent display controllers for DVI-D, D-Sub and HDMI to support dual VGA output so that DVI-D, D-sub and HDMI can drive same or different display contents.

To enable dual monitor feature, please follow the steps below:

1. Connect a DVI-D monitor cable to the DVI-D port on the I/O panel, connect a D-Sub monitor cable to the D-Sub port on the I/O panel and connect a HDMI monitor cable to the HDMI port on the I/O panel.

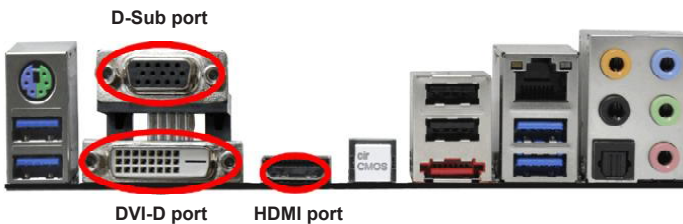

2. If you have already installed the onboard VGA driver from our support CD to your system, you can freely enjoy the benefits of dual monitor function after your system boots. If you haven't installed the onboard VGA driver yet, please install the onboard VGA driver from our support CD to your system and restart your computer.



D-Sub, DVI-D and HDMI monitors cannot be enabled at the same time. You can only choose the combination: DVI-D + HDMI, DVI-D + D-Sub, or HDMI + D-Sub.

---

## Surround Display Feature

This motherboard supports surround display upgrade. With the internal VGA output support (DVI-D, D-Sub and HDMI) and external add-on PCI Express VGA cards, you can easily enjoy the benefits of surround display feature.

Please refer to the following steps to set up a surround display environment:

1. Install the PCI Express VGA cards on PCIE2 and PCIE3 slots. Please refer to page 22 for proper expansion card installation procedures.
2. Connect a DVI-D monitor cable to the DVI-D port on the I/O panel, connect a D-Sub monitor cable to the D-Sub port on the I/O panel and connect a HDMI monitor cable to the HDMI port on the I/O panel. Then connect other monitor cables to the corresponding connectors of the add-on PCI Express VGA cards on PCIE2 and PCIE3 slots.
3. Boot your system. Press <F2> or <Del> to enter UEFI setup. Enter "Share Memory" option to adjust the memory capability to [32MB], [64MB], [128MB], [256MB] or [512MB] to enable the function of D-sub. Please make sure that the value you select is less than the total capability of the system memory. If you do not adjust the UEFI setup, the default value of "Share Memory", [Auto], will disable D-Sub function when an add-on VGA card is inserted to this motherboard.
4. Install the onboard VGA driver and the add-on PCI Express VGA card driver to your system. If you have installed the drivers already, there is no need to install them again.
5. Set up a multi-monitor display.

### For Windows® XP / XP 64-bit OS:

Right click on desktop, choose "Properties", and select the "Settings" tab so that you can adjust the parameters of the multi-monitors according to the steps below.

- A. Click the "Identify" button to display a large number on each monitor.
- B. Right-click the display icon in the Display Properties dialog that you wish to be your primary monitor, and then select "Primary". When you use multiple monitors with your card, one monitor will always be Primary, and all additional monitors will be designated as Secondary.
- C. Select the display icon identified by the number 2.
- D. Click "Extend my Windows desktop onto this monitor".
- E. Right-click the display icon and select "Attached", if necessary.
- F. Set the appropriate "Screen Resolution" and "Color Quality" for the second monitor. Click "Apply" or "OK" to apply these new values.
- G. Repeat steps C through E for the display icon identified by the numbers three to six.



---

**For Windows® 7 / 7 64-bit / Vista™ / Vista™ 64-bit OS:**

Right click the desktop, choose “Personalize”, and select the “Display Settings” tab so that you can adjust the parameters of the multi-monitors according to the steps below.

- A. Click the number “2” icon.
- B. Click the items “This is my main monitor” and “Extend the desktop onto this monitor”.
- C. Click “OK” to save your change.
- D. Repeat steps A through C for the display icons identified by the number three to six.

6. Use Surround Display. Click and drag the display icons to positions representing the physical setup of your monitors that you would like to use. The placement of display icons determines how you move items from one monitor to another.



#### **HDCP Function**

HDCP function is supported on this motherboard. To use HDCP function with this motherboard, you need to adopt a monitor that supports HDCP function as well. Therefore, you can enjoy the superior display quality with high-definition HDCP encryption contents. Please refer to the instructions below for more details about HDCP function.

#### **What is HDCP?**

HDCP stands for High-Bandwidth Digital Content Protection, a specification developed by Intel® for protecting digital entertainment content that uses the DVI interface. HDCP is a copy protection scheme to eliminate the possibility of intercepting digital data midstream between the video source, or transmitter - such as a computer, DVD player or set-top box - and the digital display, or receiver - such as a monitor, television or projector. In other words, HDCP specification is designed to protect the integrity of content as it is being transmitted.

Products compatible with the HDCP scheme such as DVD players, satellite and cable HDTV set-top-boxes, as well as few entertainment PCs requires a secure connection to a compliant display. Due to the increase in manufacturers employing HDCP in their equipment, it is highly recommended that the HDTV or LCD monitor you purchase is compatible.

## 2.10 ASRock Smart Remote Installation Guide

ASRock Smart Remote is only used for ASRock motherboard with CIR header. Please refer to below procedures for the quick installation and usage of ASRock Smart Remote.

Step1. Find the CIR header located next to the USB 2.0 header on ASRock motherboard.



Step2. Connect the front USB cable to the USB 2.0 header (as below, pin 1-5) and the CIR header. Please make sure the wire assignments and the pin assignments are matched correctly.

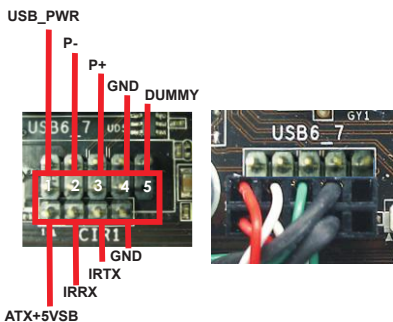

Step3. Install Multi-Angle CIR Receiver to the front USB port. If Multi-Angle CIR Receiver cannot successfully receive the infrared signals from MCE Remote Controller, please try to install it to the other front USB port.

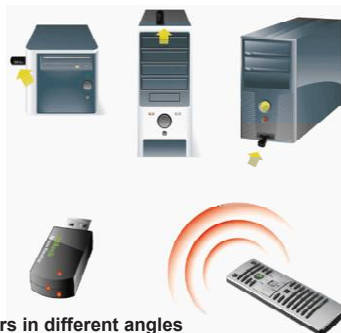

3 CIR sensors in different angles



1. Only one of the front USB port can support CIR function. When the CIR function is enabled, the other port will remain USB function.
2. Multi-Angle CIR Receiver is used for front USB only. Please do not use the rear USB bracket to connect it on the rear panel. Multi-Angle CIR Receiver can receive the multi-direction infrared signals (top, down and front), which is compatible with most of the chassis on the market.
3. The Multi-Angle CIR Receiver does not support Hot-Plug function. Please install it before you boot the system.



\* ASRock Smart Remote is only supported by some of ASRock motherboards. Please refer to ASRock website for the motherboard support list: <http://www.asrock.com>

---

## 2.1.1 Jumpers Setup

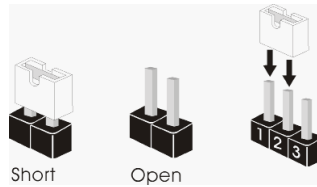
The illustration shows how jumpers are set up. When the jumper cap is placed on pins, the jumper is “Short”. If no jumper cap is placed on pins, the jumper is “Open”. The illustration shows a 3-pin jumper whose pin1 and pin2 are “Short” when jumper cap is placed on these 2 pins.



Jumper	Setting	Description
Clear CMOS Jumper (CLR CMOS1) (see p.13, No. 15)	<b>1_2</b>  Default	<b>2_3</b>  Clear CMOS

Note: CLR CMOS1 allows you to clear the data in CMOS. To clear and reset the system parameters to default setup, please turn off the computer and unplug the power cord from the power supply. After waiting for 15 seconds, use a jumper cap to short pin2 and pin3 on CLR CMOS1 for 5 seconds. However, please do not clear the CMOS right after you update the BIOS. If you need to clear the CMOS when you just finish updating the BIOS, you must boot up the system first, and then shut it down before you do the clear-CMOS action. Please be noted that the password, date, time, user default profile, 1394 GUID and MAC address will be cleared only if the CMOS battery is removed.



The Clear CMOS Switch has the same function as the Clear CMOS jumper.

## 2.12 Onboard Headers and Connectors



Onboard headers and connectors are NOT jumpers. Do NOT place jumper caps over these headers and connectors. Placing jumper caps over the headers and connectors will cause permanent damage of the motherboard!

### Serial ATA2 Connectors

(SATA2\_2\_3: see p.13, No. 13)

(SATA2\_4\_5: see p.13, No. 14)

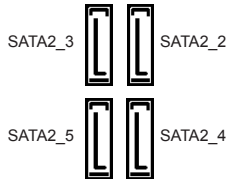

These four Serial ATA2 (SATA2) connectors support SATA data cables for internal storage devices. The current SATA2 interface allows up to 3.0 Gb/s data transfer rate.

### Serial ATA3 Connectors

(SATA3\_A0\_A1: see p.13, No. 11)

(SATA3\_0\_1: see p.13, No. 12)

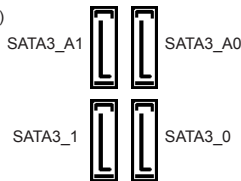

These four Serial ATA3 (SATA3) connectors support SATA data cables for internal storage devices. The current SATA3 interface allows up to 6.0 Gb/s data transfer rate. If the eSATA3 port on the rear I/O has been connected, the internal SATA3\_A1 will not function.

### Serial ATA (SATA)

#### Data Cable

(Optional)



Either end of the SATA data cable can be connected to the SATA / SATA2 / SATA3 hard disk or the SATA2 / SATA3 connector on this motherboard.

### USB 2.0 Headers

(9-pin USB2\_3)

(see p.13, No. 26)

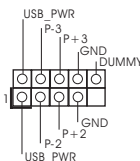

(9-pin USB4\_5)

(see p.13, No. 25)

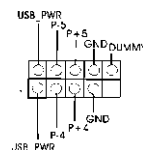

Besides two default USB 2.0 ports on the I/O panel, there are three USB 2.0 headers on this motherboard. Each USB 2.0 header can support two USB 2.0 ports.

(9-pin USB6\_7)  
(see p.13, No. 24)

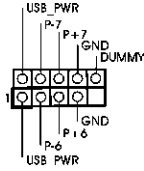

USB 3.0 Header  
(19-pin USB3\_4\_5)  
(see p.13, No. 9)

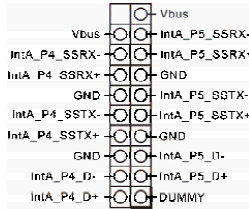

Besides four default USB 3.0 ports on the I/O panel, there is one USB 3.0 header on this motherboard. This USB 3.0 header can support two USB 3.0 ports.

Infrared Module Header  
(5-pin IR1)  
(see p.13, No. 20)

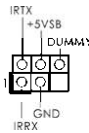

This header supports an optional wireless transmitting and receiving infrared module.

Consumer Infrared Module Header  
(4-pin CIR1)  
(see p.13 No. 27)

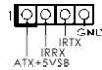

This header can be used to connect the remote controller receiver.

Front Panel Audio Header  
(9-pin HD\_AUDIO1)  
(see p.13, No. 31)

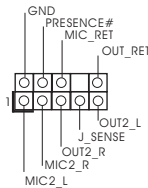

This is an interface for front panel audio cable that allows convenient connection and control of audio devices.



1. High Definition Audio supports Jack Sensing, but the panel wire on the chassis must support HDA to function correctly. Please follow the instruction in our manual and chassis manual to install your system.
2. If you use AC'97 audio panel, please install it to the front panel audio header as below:
  - A. Connect Mic\_IN (MIC) to MIC2\_L.
  - B. Connect Audio\_R (RIN) to OUT2\_R and Audio\_L (LIN) to OUT2\_L.
  - C. Connect Ground (GND) to Ground (GND).
  - D. MIC\_RET and OUT\_RET are for HD audio panel only. You don't need to connect them for AC'97 audio panel.

E. To activate the front mic.

For Windows® XP / XP 64-bit OS:

Select "Mixer". Select "Recorder". Then click "FrontMic".

For Windows® 7 / 7 64-bit / Vista™ / Vista™ 64-bit OS:

Go to the "FrontMic" Tab in the Realtek Control panel. Adjust "Recording Volume".

## System Panel Header

(9-pin PANEL1)

(see p.13, No. 20)

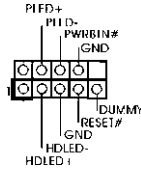

This header accommodates several system front panel functions.



Connect the power switch, reset switch and system status indicator on the chassis to this header according to the pin assignments below. Note the positive and negative pins before connecting the cables.

### **PWRBTN (Power Switch):**

Connect to the power switch on the chassis front panel. You may configure the way to turn off your system using the power switch.

### **RESET (Reset Switch):**

Connect to the reset switch on the chassis front panel. Press the reset switch to restart the computer if the computer freezes and fails to perform a normal restart.

### **PLED (System Power LED):**

Connect to the power status indicator on the chassis front panel. The LED is on when the system is operating. The LED keeps blinking when the system is in S1/S3 sleep state. The LED is off when the system is in S4 sleep state or powered off (S5).

### **HDLED (Hard Drive Activity LED):**

Connect to the hard drive activity LED on the chassis front panel. The LED is on when the hard drive is reading or writing data.

The front panel design may differ by chassis. A front panel module mainly consists of power switch, reset switch, power LED, hard drive activity LED, speaker and etc. When connecting your chassis front panel module to this header, make sure the wire assignments and the pin assignments are matched correctly.

## Chassis Speaker Header

(4-pin SPEAKER 1)

(see p.13, No. 17)

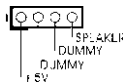

Please connect the chassis speaker to this header.

## Power LED Header

(3-pin PLED1)

(see p.13, No. 19)



Please connect the chassis power LED to this header to indicate system power status. The LED is on when the system is operating. The LED keeps blinking in S1/S3 state. The LED is off in S4 state or S5 state (power off).

## Chassis and Power Fan Connectors

(4-pin CHA\_FAN1)

(see p.13, No. 22)



(3-pin CHA\_FAN2)

(see p.13, No. 38)

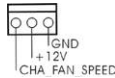

(3-pin CHA\_FAN3)

(see p.13, No. 39)

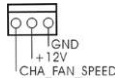

(3-pin PWR\_FAN1)

(see p.13, No. 4)

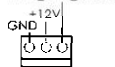

Please connect the fan cables to the fan connectors and match the black wire to the ground pin. CHA\_FAN1, CHA\_FAN2 and CHA\_FAN3 support Fan Control.

## CPU Fan Connectors

(4-pin CPU\_FAN1)

(see p.13, No. 3)

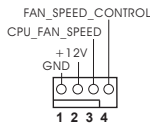

Please connect the CPU fan cable to the connector and match the black wire to the ground pin.



Though this motherboard provides 4-Pin CPU fan (Quiet Fan) support, the 3-Pin CPU fan still can work successfully even without the fan speed control function. If you plan to connect the 3-Pin CPU fan to the CPU fan connector on this motherboard, please connect it to Pin 1-3.

Pin 1-3 Connected ←

3-Pin Fan Installation



(3-pin CPU\_FAN2)

(see p.13, No. 5)

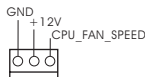

## ATX Power Connector

(24-pin ATXPWR1)

(see p.13, No. 8)

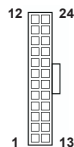

Please connect an ATX power supply to this connector.



Though this motherboard provides 24-pin ATX power connector, it can still work if you adopt a traditional 20-pin ATX power supply. To use the 20-pin ATX power supply, please plug your power supply along with Pin 1 and Pin 13.



20-Pin ATX Power Supply Installation

### ATX 12V Power Connector

(8-pin ATX12V1)

(see p.13, No. 1)



Please connect an ATX 12V

power supply to this connector.



Though this motherboard provides 8-pin ATX 12V power connector, it can still work if you adopt a traditional 4-pin ATX 12V power supply. To use the 4-pin ATX power supply, please plug your power supply along with Pin 1 and Pin 5.

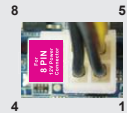

4-Pin ATX 12V Power Supply Installation

### Serial port Header

(9-pin COM1)

(see p.13, No. 28)

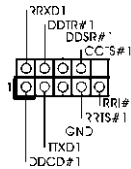

This COM1 header supports a

serial port module.

### HDMI\_SPDIF Header

(2-pin HDMI\_SPDIF1)

(see p.13, No. 29)



HDMI\_SPDIF header, providing

SPDIF audio output to HDMI

VGA card, allows the system to

connect HDMI Digital TV/

projector/LCD devices. Please

connect the HDMI\_SPDIF

connector of HDMI VGA card to

this header.



---

## 2.13 Smart Switches

The motherboard has three smart switches: power switch, reset switch and clear CMOS switch, allowing users to quickly turn on/off or reset the system clear the CMOS values.

---

Power Switch  
(PWRBTN)  
(see p.13 No. 18)



Power Switch is a smart switch, allowing users to quickly turn on/off the system.

---

Reset Switch  
(RSTBTN)  
(see p.13 No. 16)



Reset Switch is a smart switch, allowing users to quickly reset the system.

---

Clear CMOS Switch  
(CLRBTN)  
(see p.14 No. 13)



Clear CMOS Switch is a smart switch, allowing users to quickly clear the CMOS values.

---

## 2.14 Dr. Debug

Dr. Debug is used to provide code information, which makes troubleshooting even easier. Please see the diagrams below for reading the Dr. Debug codes.

Status Code	Description
0x00	Not used
0x01	Power on. Reset type detection (soft/hard)
0x02	AP initialization before microcode loading
0x03	North Bridge initialization before microcode loading
0x04	South Bridge initialization before microcode loading
0x05	OEM initialization before microcode loading
0x06	Microcode loading
0x07	AP initialization after microcode loading
0x08	North Bridge initialization after microcode loading
0x09	South Bridge initialization after microcode loading
0x0A	OEM initialization after microcode loading
0x0B	Cache initialization
0x0C – 0x0D	Reserved for future AMI SEC error codes
0x0E	Microcode not found
0x0F	Microcode not loaded
0x10	PEI Core is started
0x11	Pre-memory CPU initialization is started
0x12	Pre-memory CPU initialization (CPU module specific)
0x13	Pre-memory CPU initialization (CPU module specific)
0x14	Pre-memory CPU initialization (CPU module specific)
0x15	Pre-memory North Bridge initialization is started
0x16	Pre-Memory North Bridge initialization (North Bridge module specific)
0x17	Pre-Memory North Bridge initialization (North Bridge module specific)
0x18	Pre-Memory North Bridge initialization (North Bridge module specific)
0x19	Pre-memory South Bridge initialization is started
0x1A	Pre-memory South Bridge initialization (South Bridge module specific)
0x1B	Pre-memory South Bridge initialization (South Bridge module specific)
0x1C	Pre-memory South Bridge initialization (South Bridge module specific)
0x1D – 0x2A	OEM pre-memory initialization codes
0x2B	Memory initialization. Serial Presence Detect (SPD) data reading
0x2C	Memory initialization. Memory presence detection
0x2D	Memory initialization. Programming memory timing information
0x2E	Memory initialization. Configuring memory
0x2F	Memory initialization (other)
0x30	Reserved for ASL
0x31	Memory Installed
0x32	CPU post-memory initialization is started
0x33	CPU post-memory initialization. Cache initialization
0x34	CPU post-memory initialization. Application Processor(s) (AP) initialization
0x35	CPU post-memory initialization. Boot Strap Processor (BSP) selection
0x36	CPU post-memory initialization. System Management Mode (SMM) initialization

0x37	Post-Memory North Bridge initialization is started
0x38	Post-Memory North Bridge initialization (North Bridge module specific)
0x39	Post-Memory North Bridge initialization (North Bridge module specific)
0x3A	Post-Memory North Bridge initialization (North Bridge module specific)
0x3B	Post-Memory South Bridge initialization is started
0x3C	Post-Memory South Bridge initialization (South Bridge module specific)
0x3D	Post-Memory South Bridge initialization (South Bridge module specific)
0x3E	Post-Memory South Bridge initialization (South Bridge module specific)
0x3F-0x4E	OEM post memory initialization codes
0x4F	DXE IPL is started
0x50	Memory initialization error. Invalid memory type or incompatible memory speed
0x51	Memory initialization error. SPD reading has failed
0x52	Memory initialization error. Invalid memory size or memory modules do not match
0x53	Memory initialization error. No usable memory detected
0x54	Unspecified memory initialization error
0x55	Memory not installed
0x56	Invalid CPU type or Speed
0x57	CPU mismatch
0x58	CPU self test failed or possible CPU cache error
0x59	CPU micro-code is not found or micro-code update is failed
0x5A	Internal CPU error
0x5B	reset PPI is not available
0x5C-0x5F	Reserved for future AMI error codes
0xE0	S3 Resume is started (S3 Resume PPI is called by the DXE IPL)
0xE1	S3 Boot Script execution
0xE2	Video repost
0xE3	OS S3 wake vector call
0xE4-0xE7	Reserved for future AMI progress codes
0xE8	S3 Resume Failed
0xE9	S3 Resume PPI not Found
0xEA	S3 Resume Boot Script Error
0xEB	S3 OS Wake Error
0xEC-0xEF	Reserved for future AMI error codes
0xF0	Recovery condition triggered by firmware (Auto recovery)
0xF1	Recovery condition triggered by user (Forced recovery)
0xF2	Recovery process started
0xF3	Recovery firmware image is found
0xF4	Recovery firmware image is loaded
0xF5-0xF7	Reserved for future AMI progress codes
0xF8	Recovery PPI is not available
0xF9	Recovery capsule is not found
0xFA	Invalid recovery capsule
0xFB – 0xFF	Reserved for future AMI error codes
0x60	DXE Core is started
0x61	NVRAM initialization

0x62	Installation of the South Bridge Runtime Services
0x63	CPU DXE initialization is started
0x64	CPU DXE initialization (CPU module specific)
0x65	CPU DXE initialization (CPU module specific)
0x66	CPU DXE initialization (CPU module specific)
0x67	CPU DXE initialization (CPU module specific)
0x68	PCI host bridge initialization
0x69	North Bridge DXE initialization is started
0x6A	North Bridge DXE SMM initialization is started
0x6B	North Bridge DXE initialization (North Bridge module specific)
0x6C	North Bridge DXE initialization (North Bridge module specific)
0x6D	North Bridge DXE initialization (North Bridge module specific)
0x6E	North Bridge DXE initialization (North Bridge module specific)
0x6F	North Bridge DXE initialization (North Bridge module specific)
0x70	South Bridge DXE initialization is started
0x71	South Bridge DXE SMM initialization is started
0x72	South Bridge devices initialization
0x73	South Bridge DXE Initialization (South Bridge module specific)
0x74	South Bridge DXE Initialization (South Bridge module specific)
0x75	South Bridge DXE Initialization (South Bridge module specific)
0x76	South Bridge DXE Initialization (South Bridge module specific)
0x77	South Bridge DXE Initialization (South Bridge module specific)
0x78	ACPI module initialization
0x79	CSM initialization
0x7A – 0x7F	Reserved for future AMI DXE codes
0x80 – 0x8F	OEM DXE initialization codes
0x90	Boot Device Selection (BDS) phase is started
0x91	Driver connecting is started
0x92	PCI Bus initialization is started
0x93	PCI Bus Hot Plug Controller Initialization
0x94	PCI Bus Enumeration
0x95	PCI Bus Request Resources
0x96	PCI Bus Assign Resources
0x97	Console Output devices connect
0x98	Console input devices connect
0x99	Super IO Initialization
0x9A	USB initialization is started
0x9B	USB Reset
0x9C	USB Detect
0x9D	USB Enable
0x9E – 0x9F	Reserved for future AMI codes
0xA0	IDE initialization is started
0xA1	IDE Reset
0xA2	IDE Detect
0xA3	IDE Enable
0xA4	SCSI initialization is started
0xA5	SCSI Reset

---

0xA6	SCSI Detect
0xA7	SCSI Enable
0xA8	Setup Verifying Password
0xA9	Start of Setup
0xAA	Reserved for ASL (see ASL Status Codes section below)
0xAB	Setup Input Wait
0xAC	Reserved for ASL (see ASL Status Codes section below)
0xAD	Ready To Boot event
0xAE	Legacy Boot event
0xAF	Exit Boot Services event
0xB0	Runtime Set Virtual Address MAP Begin
0xB1	Runtime Set Virtual Address MAP End
0xB2	Legacy Option ROM Initialization
0xB3	System Reset
0xB4	USB hot plug
0xB5	PCI bus hot plug
0xB6	Clean-up of NVRAM
0xB7	Configuration Reset (reset of NVRAM settings)
0xB8 – 0xBF	Reserved for future AMI codes
0xC0 – 0xCF	OEM BDS initialization codes
0xD0	CPU initialization error
0xD1	North Bridge initialization error
0xD2	South Bridge initialization error
0xD3	Some of the Architectural Protocols are not available
0xD4	PCI resource allocation error. Out of Resources
0xD5	No Space for Legacy Option ROM
0xD6	No Console Output Devices are found
0xD7	No Console Input Devices are found
0xD8	Invalid password
0xD9	Error loading Boot Option (LoadImage returned error)
0xDA	Boot Option is failed (StartImage returned error)
0xDB	Flash update is failed
0xDC	Reset protocol is not available

---

## 2.15 Serial ATA (SATA) / Serial ATA2 (SATA2) Hard Disks Installation

This motherboard adopts Intel® Z77 chipset that supports Serial ATA (SATA) / Serial ATA2 (SATA2) hard disks and RAID (RAID 0, RAID 1, RAID 5, RAID 10, Intel Rapid Storage and Intel Smart Response Technology) functions. You may install SATA / SATA2 hard disks on this motherboard for internal storage devices. This section will guide you to install the SATA / SATA2 hard disks.

STEP 1: Install the SATA / SATA2 hard disks into the drive bays of your chassis.

STEP 2: Connect the SATA power cable to the SATA / SATA2 hard disk.

STEP 3: Connect one end of the SATA data cable to the motherboard's SATA2 connector.

STEP 4: Connect the other end of the SATA data cable to the SATA / SATA2 hard disk.

## 2.16 Serial ATA3 (SATA3) Hard Disks Installation

This motherboard adopts Intel® Z77 chipset that supports Serial ATA3 (SATA3) hard disks and RAID (RAID 0, RAID 1, RAID 5, RAID 10, Intel Rapid Storage and Intel Smart Response Technology) functions for SATA3\_0 and SATA3\_1 connectors. ASMedia ASM1061 chipset supports Serial ATA3 (SATA3) hard disks for SATA3\_A0 and SATA3\_A1 connectors. You may install SATA3 hard disks on this motherboard for internal storage devices. This section will guide you to install the SATA3 hard disks.

STEP 1: Install the SATA3 hard disks into the drive bays of your chassis.

STEP 2: Connect the SATA power cable to the SATA3 hard disk.

STEP 3: Connect one end of the SATA data cable to the motherboard's SATA3 connector.

STEP 4: Connect the other end of the SATA data cable to the SATA3 hard disk.



Please be noted that SATA3\_A0 and SATA3\_A1 do not support RAID function. If you want to use RAID function on SATA3 connectors, please use SATA3\_0 and SATA3\_1 connectors.

---

## 2.17 Hot Plug and Hot Swap Functions for SATA / SATA2 HDDs

This motherboard supports Hot Plug and Hot Swap functions for SATA / SATA2 in RAID / AHCI mode. Intel® Z77 chipset provides hardware support for Advanced Host controller Interface (AHCI), a new programming interface for SATA host controllers developed through a joint industry effort.



### NOTE

#### What is Hot Plug Function?

If the SATA / SATA2 HDDs are NOT set for RAID configuration, it is called “Hot Plug” for the action to insert and remove the SATA / SATA2 HDDs while the system is still power-on and in working condition.

However, please note that it cannot perform Hot Plug if the OS has been installed into the SATA / SATA2 HDD.

#### What is Hot Swap Function?

If SATA / SATA2 HDDs are built as RAID 1 or RAID 5 then it is called “Hot Swap” for the action to insert and remove the SATA / SATA2 HDDs while the system is still power-on and in working condition.

## 2.18 Hot Plug and Hot Swap Functions for SATA3 HDDs

This motherboard supports Hot Plug and Hot Swap functions for SATA3 in RAID / AHCI mode. Intel® Z77 and ASMedia ASM1061 chipsets provide hardware support for Advanced Host controller Interface (AHCI), a new programming interface for SATA host controllers developed through a joint industry effort.



### NOTE

#### What is Hot Plug Function?

If the SATA3 HDDs are NOT set for RAID configuration, it is called “Hot Plug” for the action to insert and remove the SATA3 HDDs while the system is still power-on and in working condition.

However, please note that it cannot perform Hot Plug if the OS has been installed into the SATA3 HDD.

#### What is Hot Swap Function?

If SATA3 HDDs are built as RAID 1 or RAID 5 then it is called “Hot Swap” for the action to insert and remove the SATA3 HDDs while the system is still power-on and in working condition.

---

## 2.19 SATA / SATA2 / SATA3 HDD Hot Plug Feature and Operation Guide

This motherboard supports Hot Plug feature for SATA / SATA2 / SATA3 HDD in RAID / AHCI mode. Please read below operation guide of Hot Plug feature carefully. Before you process the SATA / SATA2 / SATA3 HDD Hot Plug, please check below cable accessories from the motherboard gift box pack.

A. 7-pin SATA data cable

B. SATA power cable with SATA 15-pin power connector interface

A. SATA data cable (Red)

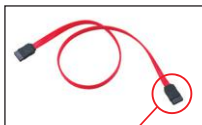

SATA 7-pin  
connector

B. SATA power cable



The SATA 15-pin power  
connector (Black) connect  
to SATA / SATA2 / SATA3 HDD

1x4-pin conventional  
power connector (White)  
connect to power supply

### Caution

1. Without SATA 15-pin power connector interface, the SATA / SATA2 / SATA3 Hot Plug cannot be processed.
2. Even some SATA / SATA2 / SATA3 HDDs provide both SATA 15-pin power connector and IDE 1x4-pin conventional power connector interfaces, the IDE 1x4-pin conventional power connector interface is definitely not able to support Hot Plug and will cause the HDD damage and data loss.

### Points of attention, before you process the Hot Plug:

1. Below operation procedure is designed only for our motherboard, which supports SATA / SATA2 / SATA3 HDD Hot Plug.
    - \* The SATA / SATA2 / SATA3 Hot Plug feature might not be supported by the chipset because of its limitation, the SATA / SATA2 / SATA3 Hot Plug support information of our motherboard is indicated in the product spec on our website: [www.asrock.com](http://www.asrock.com)
  2. Make sure your SATA / SATA2 / SATA3 HDD can support Hot Plug function from your dealer or HDD user manual. The SATA / SATA2 / SATA3 HDD, which cannot support Hot Plug function, will be damaged under the Hot Plug operation.
  3. Please make sure the SATA / SATA2 / SATA3 driver is installed into system properly. The latest SATA / SATA2 / SATA3 driver is available on our support website: [www.asrock.com](http://www.asrock.com)
  4. Make sure to use the SATA power cable & data cable, which are from our motherboard package.
  5. Please follow below instructions step by step to reduce the risk of HDD crash or data loss.
-



---

## How to Hot Plug a SATA / SATA2 / SATA3 HDD:

Points of attention, before you process the Hot Plug:

Please do follow below instruction sequence to process the Hot Plug, improper procedure will cause the SATA / SATA2 / SATA3 HDD damage and data loss.

**Step 1** Please connect SATA power cable 1x4-pin end (White) to the power supply 1x4-pin cable.

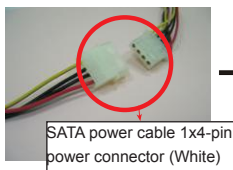

**Step 2** Connect SATA data cable to the motherboard's SATA2 / SATA3 connector.

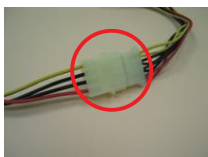

**Step 3** Connect SATA 15-pin power cable connector (Black) end to SATA / SATA2 / SATA3 HDD.



**Step 4** Connect SATA data cable to the SATA / SATA2 / SATA3 HDD.



## How to Hot Unplug a SATA / SATA2 / SATA3 HDD:

Points of attention, before you process the Hot Unplug:

Please do follow below instruction sequence to process the Hot Unplug, improper procedure will cause the SATA / SATA2 / SATA3 HDD damage and data loss.

**Step 1** Unplug SATA data cable from SATA / SATA2 / SATA3 HDD side.



**Step 2** Unplug SATA 15-pin power cable connector (Black) from SATA / SATA2 / SATA3 HDD side.



---

## 2.20 Driver Installation Guide

To install the drivers to your system, please insert the support CD to your optical drive first. Then, the drivers compatible to your system can be auto-detected and listed on the support CD driver page. Please follow the order from up to bottom side to install those required drivers. Therefore, the drivers you install can work properly.

## 2.21 Installing Windows® 7 / 7 64-bit / Vista™ / Vista™ 64-bit With RAID Functions

If you want to install Windows® 7 / 7 64-bit / Vista™ / Vista™ 64-bit OS on your SATA / SATA2 / SATA3 HDDs with RAID functions, please follow the steps below.



RAID mode is not supported under Windows® XP / XP 64-bit.

### STEP 1: Set up UEFI.

- A. Enter UEFI SETUP UTILITY → Advanced screen → Storage Configuration.
- B. Set the option “SATA Mode Selection” to [RAID] for SATA2\_2 to SATA2\_5 and SATA3\_0 and SATA3\_1 ports.

### STEP 2: Use “RAID Installation Guide” to set RAID configuration.

Before you start to configure the RAID function, you need to check the installation guide in the Support CD for proper configuration. Please refer to the document in the Support CD, “Guide to SATA Hard Disks Installation and RAID Configuration”, which is located in the folder at the following path:

.. \ RAID Installation Guide

### STEP 3: Install Windows® 7 / 7 64-bit / Vista™ / Vista™ 64-bit OS on your system.

After the installation of Windows® 7 / 7 64-bit / Vista™ / Vista™ 64-bit OS, if you want to manage RAID functions, you are allowed to use both “RAID Installation Guide” and “Intel Rapid Storage Information” for RAID configuration. Please refer to the document in the Support CD, “Guide to SATA Hard Disks Installation and RAID Configuration”, which is located in the folder at the following path: .. \ RAID Installation Guide and the document in the support CD, “Guide to Intel Rapid Storage”, which is located in the folder at the following path: .. \ Intel Rapid Storage Information



If you want to use “Intel Rapid Storage” in Windows® environment, install “SATAII driver” from the Support CD again so that “Intel Rapid Storage” will be installed to your system as well.

---

## 2.22 Installing Windows® 7 / 7 64-bit / Vista™ / Vista™ 64-bit / XP / XP 64-bit Without RAID Functions

If you want to install Windows® 7 / 7 64-bit / Vista™ / Vista™ 64-bit / XP / XP 64-bit OS on your SATA / SATA2 / SATA3 HDDs without RAID functions, please follow below procedures according to the OS you install.

### 2.22.1 Installing Windows® XP / XP 64-bit Without RAID Functions

If you want to install Windows® XP / XP 64-bit OS on your SATA / SATA2 / SATA3 HDDs without RAID functions, please follow below steps.



AHCI mode is not supported under Windows® XP / XP 64-bit.

#### Using SATA / SATA2 / SATA3 HDDs without NCQ function

##### STEP 1: Set Up UEFI.

A. Enter UEFI SETUP UTILITY → Advanced screen → Storage Configuration.

B. Set the option “SATA Mode Selection” to [IDE] for SATA2\_2 to SATA2\_5 and SATA3\_0 and SATA3\_1 ports.

Set the option “ASMedia SATA3 Mode” to [IDE] for SATA3\_A0 and SATA2\_A1 ports.

##### STEP 2: Install Windows® XP / XP 64-bit OS on your system.

## 2.22.2 Installing Windows® 7 / 7 64-bit / Vista™ / Vista™ 64-bit Without RAID Functions

If you want to install Windows® 7 / 7 64-bit / Vista™ / Vista™ 64-bit OS on your SATA / SATA2 / SATA3 HDDs without RAID functions, please follow below steps.

#### Using SATA / SATA2 / SATA3 HDDs with NCQ function

##### STEP 1: Set Up UEFI.

A. Enter UEFI SETUP UTILITY → Advanced screen → Storage Configuration.

B. Set the option “SATA Mode Selection” to [AHCI] for SATA2\_2 to SATA2\_5 and SATA3\_0 and SATA3\_1 ports.

Set the option “ASMedia SATA3 Mode” to [AHCI] for SATA3\_A0 and SATA2\_A1 ports.

##### STEP 2: Install Windows® 7 / 7 64-bit / Vista™ / Vista™ 64-bit OS on your system.

---

## Using SATA / SATA2 / SATA3 HDDs without NCQ function

### **STEP 1: Set Up UEFI.**

A. Enter UEFI SETUP UTILITY → Advanced screen → Storage Configuration.

B. Set the option "SATA Mode Selection" to [IDE] for SATA2\_2 to SATA2\_5 and SATA3\_0 and SATA3\_1 ports.

Set the option "ASMedia SATA3 Mode" to [IDE] for SATA3\_A0 and SATA2\_A1 ports.

**STEP 2: Install Windows® 7 / 7 64-bit / Vista™ / Vista™ 64-bit OS on your system.**

---

## Chapter 3: UEFI SETUP UTILITY

### 3.1 Introduction

This section explains how to use the UEFI SETUP UTILITY to configure your system. The UEFI chip on the motherboard stores the UEFI SETUP UTILITY. You may run the UEFI SETUP UTILITY when you start up the computer. Please press <F2> or <Del> during the Power-On-Self-Test (POST) to enter the UEFI SETUP UTILITY, otherwise, POST will continue with its test routines.

If you wish to enter the UEFI SETUP UTILITY after POST, restart the system by pressing <Ctl> + <Alt> + <Delete>, or by pressing the reset button on the system chassis. You may also restart by turning the system off and then back on.



Because the UEFI software is constantly being updated, the following UEFI setup screens and descriptions are for reference purpose only, and they may not exactly match what you see on your screen.

#### 3.1.1 UEFI Menu Bar

The top of the screen has a menu bar with the following selections:

<b>Main</b>	To set up the system time/date information
<b>OC Tweaker</b>	To set up overclocking features
<b>Advanced</b>	To set up the advanced UEFI features
<b>H/W Monitor</b>	To display current hardware status
<b>Boot</b>	To set up the default system device to locate and load the Operating System
<b>Security</b>	To set up the security features
<b>Exit</b>	To exit the current screen or the UEFI SETUP UTILITY

Use < ← > key or < → > key to choose among the selections on the menu bar, and then press <Enter> to get into the sub screen. You can also use the mouse to click your required item.

### 3.1.2 Navigation Keys

Please check the following table for the function description of each navigation key.

Navigation Key(s)	Function Description
← / →	Moves cursor left or right to select Screens
↑ / ↓	Moves cursor up or down to select items
+ / -	To change option for the selected items
<Tab>	Switch to next function
<Enter>	To bring up the selected screen
<PGUP>	Go to the previous page
<PGDN>	Go to the next page
<HOME>	Go to the top of the screen
<END>	Go to the bottom of the screen
<F1>	To display the General Help Screen
<F7>	Discard changes and exit the UEFI SETUP UTILITY
<F9>	Load optimal default values for all the settings
<F10>	Save changes and exit the UEFI SETUP UTILITY
<F12>	Print screen
<ESC>	Jump to the Exit Screen or exit the current screen

### 3.2 Main Screen

When you enter the UEFI SETUP UTILITY, the Main screen will appear and display the system overview.

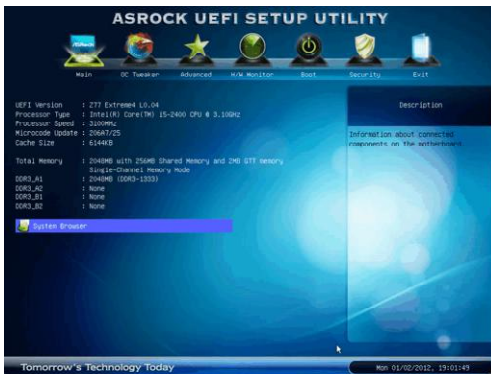

#### System Browser

System Browser can let you easily check your current system configuration in UEFI setup.

---

### 3.3 OC Tweaker Screen

In the OC Tweaker screen, you can set up overclocking features.



#### Load Optimized CPU OC Setting

You can use this option to load optimized CPU overclocking setting. Please note that overcloing may cause damage to your CPU and motherboard. It should be done at your own risk and expense.

#### CPU Configuration

##### CPU Turbo Ratio

Use this item to change the ratio value of this motherboard.

##### Host Clock Override (BCLK)

Use this to adjust the host clock (BCLK) frequency. The default value is [Auto].

##### Spread Spectrum

This item should always be [Auto] for better system stability.

##### Intel SpeedStep Technology

Intel SpeedStep technology is Intel's new power saving technology. Processors can switch between multiple frequencies and voltage points to enable power saving. The default value is [Enabled]. Configuration options: [Enabled] and [Disabled]. If you install Windows® Vista™ / 7 and want to enable this function, please set this item to [Enabled]. This item will be hidden if the current CPU does not support Intel SpeedStep technology.



Please note that enabling this function may reduce CPU voltage and lead to system stability or compatibility issues with some power supplies. Please set this item to [Disabled] if above issues occur.

---

### **Intel Turbo Boost Technology**

Use this item to enable or disable Intel Turbo Boost Mode Technology. Turbo Boost Mode allows processor cores to run faster than marked frequency in specific conditions. The default value is [Enabled].

### **Additional Turbo Voltage**

Use this item to add voltage when CPU is in Turbo mode.

### **Internal PLL Overvoltage**

Use this item to enable/disable CPU Internal PLL Overvoltage Function.

### **Long Duration Power Limit**

Use this item to configure long duration power limit in watts. The default value is [Auto].

### **Long Duration Maintained**

Use this item to configure time window which the long duration power is maintained. The default value is [Auto].

### **Short Duration Power Limit**

Use this item to configure short duration power limit in watts. The default value is [Auto].

### **Primary Plane Current Limit**

Use this item to configure the maximum instantaneous current allowed for the primary plane. The default value is [Auto].

### **Secondary Plane Current Limit**

Use this item to configure the maximum instantaneous current allowed for the secondary plane. The default value is [Auto].

### **GT OverClocking Support**

Use this item to enable or disable GT OverClocking Support. The default value is [Disabled].

## **DRAM Timing Configuration**

### **Load XMP Setting**

Use this to load XMP setting. Configuration options: [Auto], [Default], [Profile 1] and [Profile 2]. The default value is [Auto].

### **DRAM Frequency**

If [Auto] is selected, the motherboard will detect the memory module(s) inserted and assign the appropriate frequency automatically.



---

## DRAM Configuration



### DRAM tCL

Use this item to change CAS# Latency (tCL) Auto/Manual setting. The default is [Auto].

### DRAM tRCD

Use this item to change RAS# to CAS# Delay (tRCD) Auto/Manual setting. The default is [Auto].

### DRAM tRP

Use this item to change Row Precharge Time (tRP) Auto/Manual setting. The default is [Auto].

### DRAM tRAS

Use this item to change RAS# Active Time (tRAS) Auto/Manual setting. The default is [Auto].

### Command Rate (CR)

Use this item to change Command Rate (CR) Auto/Manual setting. The default is [Auto].

### DRAM tWR

Use this item to change Write Recovery Time (tWR) Auto/Manual setting. The default is [Auto].

### DRAM tRFC

Use this item to change Refresh Cycle Time (tRFC) Auto/Manual setting. The default is [Auto].

### DRAM tRRD

Use this item to change RAS to RAS Delay (tRRD) Auto/Manual setting. The default is [Auto].

### DRAM tWTR

Use this item to change Write to Read Delay (tWTR) Auto/Manual setting. The default is [Auto].

---

**DRAM tRTP**

Use this item to change Read to Precharge (tRTP) Auto/Manual setting. The default is [Auto].

**DRAM tFAW**

Use this item to change Four Activate Window (tFAW) Auto/Manual setting. The default is [Auto].

**DRAM tCWL**

Use this item to change CAS# Write Latency (tCWL) Auto/Manual setting. The default is [Auto].

**ODT WR (CH A)**

Use this item to change ODT WR (CH A) setting. The default is [Auto].

**ODT WR (CH B)**

Use this item to change ODT WR (CH B) setting. The default is [Auto].

**ODT NOM (CH A)**

Use this item to change ODT NOM (CH A) setting. The default is [Auto].

**ODT NOM (CH B)**

Use this item to change ODT NOM (CH B) setting. The default is [Auto].

**MRC Fast Boot**

Use this item to enable or disable MRC Fast Boot. The default is [Enabled].

**Voltage Configuration****CPU Core Voltage**

Use this to select CPU Core Voltage. The default value is [Auto].

**CPU Load-Line Calibration**

CPU Load-Line Calibration helps prevent CPU voltage droop when the system is under heavy load.

**IGPU Voltage**

Use this to select IGPU Voltage. The default value is [Auto].

**IGPU Load-Line Calibration**

IGPU Load-Line Calibration helps prevent IGPU voltage droop when the system is under heavy load.

**DRAM Voltage**

Use this to select DRAM Voltage. The default value is [Auto].

**VTT Voltage**

Use this to select VTT Voltage. The default value is [Auto].

**PCH Voltage**

Use this to select PCH Voltage. The default value is [Auto].

**CPU PLL Voltage**

Use this to select CPU PLL Voltage. The default value is [Auto].

**VCCSA Voltage**

Use this to select VCCSA Voltage. The default value is [Auto].

---

## User Defaults

In this option, you are allowed to load and save three user defaults according to your own requirements.

## 3.4 Advanced Screen

In this section, you may set the configurations for the following items: CPU Configuration, North Bridge Configuration, South Bridge Configuration, Storage Configuration, Intel(R) Rapid Start Technology, Intel(R) Smart Connect Technology, Super IO Configuration, ACPI Configuration and USB Configuration.



Setting wrong values in this section may cause the system to malfunction.

### Instant Flash

Instant Flash is a UEFI flash utility embedded in Flash ROM. This convenient UEFI update tool allows you to update system UEFI without entering operating systems first like MS-DOS or Windows®. Just save the new UEFI file to your USB flash drive, floppy disk or hard drive and launch this tool, then you can update your UEFI only in a few clicks without preparing an additional floppy diskette or other complicated flash utility. Please be noted that the USB flash drive or hard drive must use FAT32/16/12 file system. If you execute Instant Flash utility, the utility will show the UEFI files and their respective information. Select the proper UEFI file to update your UEFI, and reboot your system after the UEFI update process is completed.

---

## 3.4.1 CPU Configuration



### Intel Hyper Threading Technology

To enable this feature, a computer system with an Intel processor that supports Hyper-Threading technology and an operating system that includes optimization for this technology, such as Microsoft® Windows® XP / Vista™ / 7 is required. Set to [Enabled] if using Microsoft® Windows® XP, Vista™, 7, or Linux kernel version 2.4.18 or higher. This option will be hidden if the installed CPU does not support Hyper-Threading technology.

### Active Processor Cores

Use this item to select the number of cores to enable in each processor package. The default value is [All].

### Enhance Halt State (C1E)

All processors support the Halt State (C1). The C1 state is supported through the native processor instructions HLT and MWAIT and requires no hardware support from the chipset. In the C1 power state, the processor maintains the context of the system caches.

### CPU C3 State Support

Use this to enable or disable CPU C3 (ACPI C2) report to OS.

### CPU C6 State Support

Use this to enable or disable CPU C6 (ACPI C3) report to OS.

### Package C State Support

Selected option will program into C State package limit register. The default value is [Auto].

### CPU Thermal Throttling

You may select [Enabled] to enable CPU internal thermal control mechanism to keep the CPU from overheating.

### No-Execute Memory Protection

No-Execution (NX) Memory Protection Technology is an enhancement

---

to the IA-32 Intel Architecture. An IA-32 processor with “No Execute (NX) Memory Protection” can prevent data pages from being used by malicious software to execute codes. This option will be hidden if the current CPU does not support No-Execute Memory Protection.

**Intel Virtualization Technology**

When this option is set to [Enabled], a VMM (Virtual Machine Architecture) can utilize the additional hardware capabilities provided by Vanderpool Technology. This option will be hidden if the installed CPU does not support Intel Virtualization Technology.

**Hardware Prefetcher**

Use this item to turn on/off the MLC streamer prefetcher.

**Adjacent Cache Line Prefetch**

Use this item to turn on/off prefetching of adjacent cache lines.

---

## 3.4.2 North Bridge Configuration



### Primary Graphics Adapter

This allows you to select [Onboard], [PCI] or [PCI Express] as the boot graphic adapter priority. The default value is [PCI Express].

### VT-d

Use this to enable or disable Intel® VT-d technology (Intel® Virtualization Technology for Directed I/O). The default value of this feature is [Disabled].

### PCIE 2 Link Speed

This allows you to select PCIE 2 Link Speed. The default value is [Auto].

### PCIE 3 Link Speed

This allows you to select PCIE 3 Link Speed. The default value is [Auto].

### Share Memory

This allows you to set onboard VGA share memory feature. The default value is [Auto].

### IGPU Multi-Monitor

This allows you to enable or disable IGPU Multi-Monitor. The default value is [Enabled]. If you install the PCI Express card under Windows® X / Vista™ OS, please disable this option.

### Render Standby

Use this to enable or disable Render Standby by Internal Graphics Device. The default value is [Enabled].

### Deep Render Standby

Use this to enable or disable Deep Render Standby by Internal Graphics Device. The default value is [Enabled].

---

### 3.4.3 South Bridge Configuration



#### **Onboard HD Audio**

Select [Auto], [Enabled] or [Disabled] for the onboard HD Audio feature. If you select [Auto], the onboard HD Audio will be disabled when PCI Sound Card is plugged.

#### **Front Panel**

Select [Auto] or [Disabled] for the onboard HD Audio Front Panel.

#### **Onboard HDMI HD Audio**

This allows you to enable or disable the Onboard HDMI HD Audio feature.

#### **Onboard LAN**

This allows you to enable or disable the Onboard LAN feature.

#### **Deep Sleep**

Mobile platforms support Deep S4/S5 in DC only and desktop platforms support Deep S4/S5 in AC only. The default value is [Enabled in S5].

#### **Restore on AC/Power Loss**

This allows you to set the power state after an unexpected AC/power loss. If [Power Off] is selected, the AC/power remains off when the power recovers. If [Power On] is selected, the AC/power resumes and the system starts to boot up when the power recovers.

#### **Good Night LED**

Use this item to enable or disable Power LED and LAN LED.

#### **Onboard Debug Port LED**

Use this item to enable or disable Onboard Debug Port LED.

---

## 3.4.4 Storage Configuration



### SATA Controller(s)

Use this item to enable or disable the SATA Controller feature.

### SATA Mode Selection

This item is for SATA3\_0, SATA3\_1 and SATA2\_2 to SATA2\_5 ports. Use this to select SATA mode. Configuration options: [IDE Mode], [AHCI Mode] and [RAID Mode]. The default value is [AHCI Mode].



AHCI (Advanced Host Controller Interface) supports NCQ and other new features that will improve SATA disk performance but IDE mode does not have these advantages.

### SATA Aggressive Link Power Management

Use this item to configure SATA Aggressive Link Power Management.

### Hard Disk S.M.A.R.T.

Use this item to enable or disable the S.M.A.R.T. (Self-Monitoring, Analysis, and Reporting Technology) feature. Configuration options: [Disabled] and [Enabled].

### ASMedia SATA3 Mode

This item is for SATA3\_A0 and SATA3\_A1 ports. Use this to select ASMedia SATA3 mode. Configuration options: [IDE Mode], [AHCI Mode] and [Disabled]. The default value is [AHCI Mode].

### SATA Boot ROM

Use this to enable or disable ASMedia SATA Boot ROM. The default value is [Disabled].





We recommend to use Intel® Z77 SATA ports (SATA3\_0, SATA3\_1, SATA2\_2, SATA2\_3, SATA2\_4 and SATA2\_5) for your bootable devices. This will minimum your boot time and get the best performance. But if you still want to boot from ASMedia SATA3 controller, you can still enable this in UEFI.

### 3.4.5 Intel(R) Rapid Start Technology



#### Intel(R) Rapid Start Technology

Use this item to enable or disable Intel(R) Rapid Start Technology. Intel(R) Rapid Start Technology is a new zero power hibernation mode which allows users to resume in just 5-6 seconds. The default is [Disabled].

---

### 3.4.6 Intel(R) Smart Connect Technology



#### **Intel(R) Smart Connect Technology**

Use this item to enable or disable Intel(R) Smart Connect Technology. Intel(R) Smart Connect Technology keeps your e-mail and social networks, such as Twitter, Facebook, etc. updated automatically while the computer is in sleep mode. The default is [Disabled].

---

### 3.4.7 Super IO Configuration



#### **Serial Port**

Use this item to enable or disable the onboard serial port.

#### **Serial Port Address**

Use this item to set the address for the onboard serial port. Configuration options: [3F8h / IRQ4] and [3E8h / IRQ4].

#### **Infrared Port**

Use this item to enable or disable the onboard infrared port.

---

### 3.4.8 ACPI Configuration



#### **Suspend to RAM**

Use this item to select whether to auto-detect or disable the Suspend-to-RAM feature. Selecting [Auto] will enable this feature if the OS supports it.

#### **Check Ready Bit**

Use this item to enable or disable the feature Check Ready Bit.

#### **ACPI HPET Table**

Use this item to enable or disable ACPI HPET Table. The default value is [Enabled]. Please set this option to [Enabled] if you plan to use this motherboard to submit Windows® Vista™ certification.

#### **PS/2 Keyboard Power On**

Use this item to enable or disable PS/2 keyboard to turn on the system from the power-soft-off mode.

#### **PCI Devices Power On**

Use this item to enable or disable PCI devices to turn on the system from the power-soft-off mode.

#### **Ring-In Power On**

Use this item to enable or disable Ring-In signals to turn on the system from the power-soft-off mode.

#### **RTC Alarm Power On**

Use this item to enable or disable RTC (Real Time Clock) to power on the system.

#### **USB Keyboard/Remote Power On**

Use this item to enable or disable USB Keyboard/Remote to turn on the system from the power-soft-off mode.

#### **USB Mouse Power On**

Use this item to enable or disable USB Mouse to turn on the system from the power-soft-off mode.

---

### 3.4.9 USB Configuration



#### **USB 2.0 Controller**

Use this item to enable or disable the use of USB 2.0 controller.

#### **USB 3.0 Controller**

Use this item to enable or disable the use of USB 3.0 controller.

#### **Legacy USB Support**

Use this option to select legacy support for USB devices. There are four configuration options: [Enabled], [Auto], [Disabled] and [UEFI Setup Only]. The default value is [Enabled]. Please refer to below descriptions for the details of these four options:

[Enabled] - Enables support for legacy USB.

[Auto] - Enables legacy support if USB devices are connected.

[Disabled] - USB devices are not allowed to use under legacy OS and UEFI setup when [Disabled] is selected. If you have USB compatibility issues, it is recommended to select [Disabled] to enter OS.

[UEFI Setup Only] - USB devices are allowed to use only under UEFI setup and Windows / Linux OS.

#### **Legacy USB 3.0 Support**

Use this option to enable or disable legacy support for USB 3.0 devices. The default value is [Enabled].

---

### 3.5 Hardware Health Event Monitoring Screen

In this section, it allows you to monitor the status of the hardware on your system, including the parameters of the CPU temperature, motherboard temperature, CPU fan speed, chassis fan speed, and the critical voltage.



#### CPU Fan 1 & 2 Setting

This allows you to set CPU fan 1 & 2's speed. Configuration options: [Full On] and [Automatic Mode]. The default value is [Full On].

#### Chassis Fan 1 Setting

This allows you to set chassis fan 1's speed. Configuration options: [Full On], [Automatic Mode] and [Manual]. The default value is [Full On].

#### Chassis Fan 2 Setting

This allows you to set chassis fan 2's speed. Configuration options: [Level 1] to [Level 4]. The default is value [Level 4].

#### Chassis Fan 3 Setting

This allows you to set chassis fan 3's speed. Configuration options: [Full On] and [Manual]. The default value is [Full On].

#### Over Temperature Protection

Use this to enable or disable Over Temperature Protection. The default value is [Enabled].

---

## 3.6 Boot Screen

In this section, it will display the available devices on your system for you to configure the boot settings and the boot priority.



### Setup Prompt Timeout

This shows the number of seconds to wait for setup activation key. 65535(0XFFFF) means indefinite waiting.

### Bootup Num-Lock

If this item is set to [On], it will automatically activate the Numeric Lock function after boot-up.

### PCI ROM Priority

Use this item to adjust PCI ROM Priority. The default value is [Legacy ROM].

### Full Screen Logo

Use this item to enable or disable OEM Logo. The default value is [Enabled].

### AddOn ROM Display

Use this option to adjust AddOn ROM Display. If you enable the option "Full Screen Logo" but you want to see the AddOn ROM information when the system boots, please select [Enabled]. Configuration options: [Enabled] and [Disabled]. The default value is [Enabled].

### Boot From Onboard LAN

Use this item to enable or disable the Boot From Onboard LAN feature.

### Boot Failure Guard

Enable or disable the feature of Boot Failure Guard.

### Boot Failure Guard Count

Use this item to configure Boot Failure Guard Count.

---

### 3.7 Security Screen

In this section, you may set or change the supervisor/user password for the system. For the user password, you may also clear it.





---

## 3.8 Exit Screen



### **Save Changes and Exit**

When you select this option, the following message "Save configuration changes and exit setup?" will pop-out. Select [Yes] to save the changes and exit the UEFI SETUP UTILITY.

### **Discard Changes and Exit**

When you select this option, the following message "Discard changes and exit setup?" will pop-out. Select [Yes] to exit the UEFI SETUP UTILITY without saving any changes.

### **Discard Changes**

When you select this option, the following message "Discard changes?" will pop-out. Select [Yes] to discard all changes.

### **Load UEFI Defaults**

Load UEFI default values for all the setup questions. F9 key can be used for this operation.

### **Launch EFI Shell from filesystem device**

Attempts to Launch EFI Shell application (Shell64.efi) from one of the available filesystem devices.

---

# Chapter 4: Software Support

## 4.1 Install Operating System

This motherboard supports various Microsoft® Windows® operating systems: 7 / 7 64-bit / Vista™ / Vista™ 64-bit / XP / XP 64-bit. Because motherboard settings and hardware options vary, use the setup procedures in this chapter for general reference only. Refer to your OS documentation for more information.

## 4.2 Support CD Information

The Support CD that came with the motherboard contains necessary drivers and useful utilities that enhance the motherboard's features.

### 4.2.1 Running The Support CD

To begin using the support CD, insert the CD into your CD-ROM drive. The CD automatically displays the Main Menu if "AUTORUN" is enabled in your computer. If the Main Menu does not appear automatically, locate and double click on the file "ASSETUP.EXE" from the BIN folder in the Support CD to display the menu.

### 4.2.2 Drivers Menu

The Drivers Menu shows the available device's drivers if the system detects installed devices. Please install the necessary drivers to activate the devices.

### 4.2.3 Utilities Menu

The Utilities Menu shows the application softwares that the motherboard supports. Click on a specific item then follow the installation wizard to install it.

### 4.2.4 Contact Information

If you need to contact ASRock or want to know more about ASRock, welcome to visit ASRock's website at <http://www.asrock.com>; or you may contact your dealer for further information.

---

## Installing OS on a HDD Larger Than 2TB in AHCI Mode

This motherboard adopts UEFI BIOS that allows Windows® OS to be installed on a large size HDD (>2TB). Please follow the procedures below to install the operating system.

1. Please make sure to use **Windows® Vista™ 64-bit (with SP2 or above)** or **Windows® 7 64-bit (with SP1 or above)**.
2. Press <F2> or <Delete> at system POST. Set **AHCI Mode** in UEFI Setup Utility > Advanced > Storage Configuration > SATA Mode.
3. Choose the item **“UEFI:xxx”** to boot in UEFI Setup Utility > Boot > Boot Option #1. (“xxx” is the device which contains your Windows® installation files. Normally it is an optical drive.) You can also press <F11> to launch boot menu at system POST and choose the item **“UEFI:xxx”** to boot.
4. Start Windows® installation.

---

## Installing OS on a HDD Larger Than 2TB in RAID Mode

This motherboard adopts UEFI BIOS that allows Windows® OS to be installed on a large size HDD (>2TB). Please follow the procedures below to install the operating system.

1. Please make sure to use **Windows® Vista™ 64-bit (with SP2 or above)** or **Windows® 7 64-bit (with SP1 or above)**.
2. Copy Intel® RAID drivers into a USB flash disk. You can download the driver from ASRock's website and unzip the file into a USB flash disk **OR** copy the file from ASRock motherboard support CD. (please copy the files under following directory:  
**32 bit: ..\i386\Win7\_Vista\_Intel\_v11.0.0.1032**  
**64-bit: ..\AMD64\Win7-64\_Vista64\_Intel\_v11.0.0.1032**
3. Create RAID array for you system. Please refer to "Intel RAID Installation Guide" file for details.
4. Install Windows® Vista™ 64-bit / 7 64-bit:
  - A. Insert your Windows® Vista™ 64-bit / 7 64-bit installation disc to the optical drive.
  - B. Press <F11> to launch boot menu at system POST and choose the item "UEFI:xxx" to boot.
  - C. Start Windows® Installation. When you see "Where do you want to install Windows?" page, please click "Load Driver".



- D. Plug the USB flash disk into your USB port; select "Browse" to find the RAID driver. Then choose the directory (xx\AMD64\) you have copied in the first step.

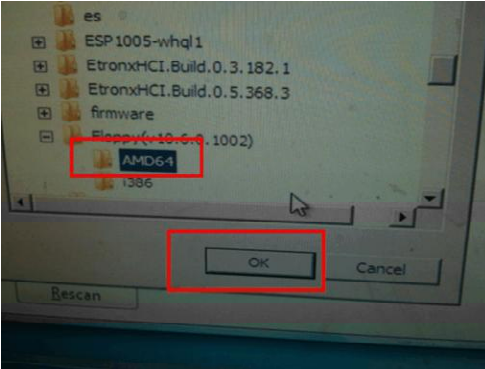

- E. Please keep the USB flash disk installed until the system's first reboot.
- F. Continue to install OS by following the Windows® instructions.
- 5. Follow Windows® Installation Guide to install OS.

If you install Windows® 7 64-bit / Vista™ 64-bit on a large hard disk (ex. Disk volume > 2TB), it may take more time to boot into Windows® or install driver/utilities. If you encounter this problem, you will need to follow the instructions below to fix this problem.

#### Windows® Vista™ 64-bit:

Microsoft® does not provide hotfix for this problem. The steps listed below are Microsoft®'s suggested solution:

##### A. Disable System Restore.

- a. Type "systempropertiesprotection" in the Start Menu. Then press "Enter".

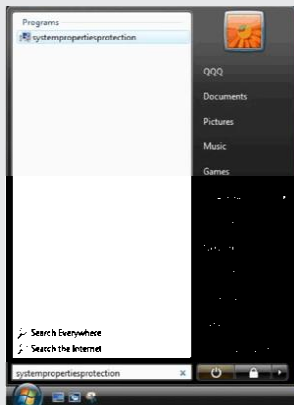

- b. De-select Local Disks for System Restore. Then Click "Turn System Restore Off" to confirm. Then Press "OK".

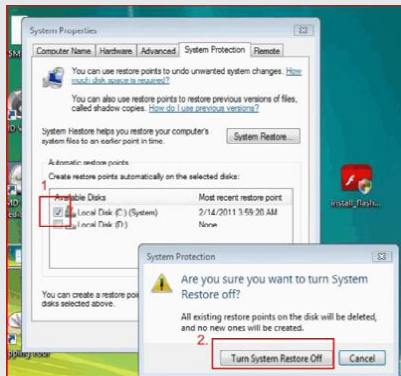

## B. Disable “Volume Shadow Copy” service.

a. Type “computer management” in the Start Menu, then press “Enter”.

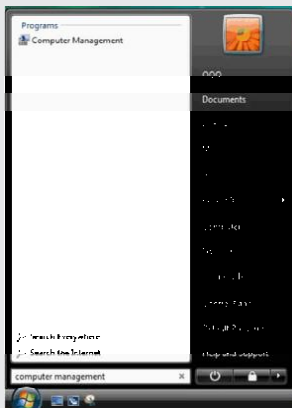

b. Go to “Services and Applications>Services”; Then double click “Volume Shadow Copy”.

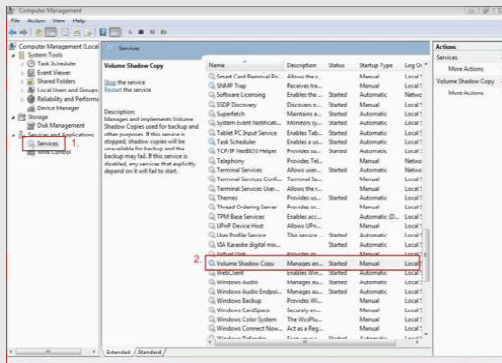

c. Set "Startup type" to "Disable" then Click "OK".

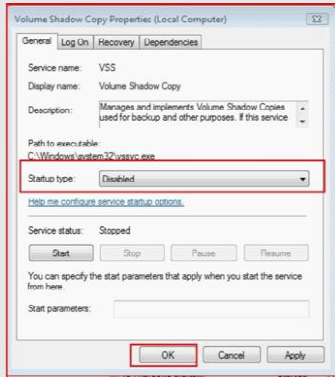

C. Reboot your system.

D. After reboot, please start to install motherboard drivers and utilities.

**Windows® 7 64-bit:**

A. Please request the hotfix KB2505454 through this link:

<http://support.microsoft.com/kb/2505454/>

B. After installing Windows® 7 64-bit, install the hotfix kb2505454.

(This may take a long time; >30 mins.)

C. Reboot your system. (It may take about 5 minutes to reboot.)

D. Windows® will install this hotfix then reboot by itself.

E. Please start to install motherboard drivers and utilities.

6. Finish.