

ASRock®

# Z690-C/ac

User Manual

Version 1.0

Published October 2021

Copyright©2021 ASRock INC. All rights reserved.

### Copyright Notice:

No part of this documentation may be reproduced, transcribed, transmitted, or translated in any language, in any form or by any means, except duplication of documentation by the purchaser for backup purpose, without written consent of ASRock Inc.

Products and corporate names appearing in this documentation may or may not be registered trademarks or copyrights of their respective companies, and are used only for identification or explanation and to the owners' benefit, without intent to infringe.

### Disclaimer:

Specifications and information contained in this documentation are furnished for informational use only and subject to change without notice, and should not be constructed as a commitment by ASRock. ASRock assumes no responsibility for any errors or omissions that may appear in this documentation.

With respect to the contents of this documentation, ASRock does not provide warranty of any kind, either expressed or implied, including but not limited to the implied warranties or conditions of merchantability or fitness for a particular purpose.

In no event shall ASRock, its directors, officers, employees, or agents be liable for any indirect, special, incidental, or consequential damages (including damages for loss of profits, loss of business, loss of data, interruption of business and the like), even if ASRock has been advised of the possibility of such damages arising from any defect or error in the documentation or product.



This device complies with Part 15 of the FCC Rules. Operation is subject to the following two conditions:

- (1) this device may not cause harmful interference, and
- (2) this device must accept any interference received, including interference that may cause undesired operation.

### CALIFORNIA, USA ONLY

The Lithium battery adopted on this motherboard contains Perchlorate, a toxic substance controlled in Perchlorate Best Management Practices (BMP) regulations passed by the California Legislature. When you discard the Lithium battery in California, USA, please follow the related regulations in advance.

“Perchlorate Material-special handling may apply, see [www.dtsc.ca.gov/hazardouswaste/perchlorate](http://www.dtsc.ca.gov/hazardouswaste/perchlorate)”

ASRock Website: <http://www.asrock.com>



## AUSTRALIA ONLY

Our goods come with guarantees that cannot be excluded under the Australian Consumer Law. You are entitled to a replacement or refund for a major failure and compensation for any other reasonably foreseeable loss or damage caused by our goods. You are also entitled to have the goods repaired or replaced if the goods fail to be of acceptable quality and the failure does not amount to a major failure. If you require assistance please call ASRock Tel : +886-2-28965588 ext.123 (Standard International call charges apply)

The terms HDMI® and HDMI High-Definition Multimedia Interface, and the HDMI logo are trademarks or registered trademarks of HDMI Licensing LLC in the United States and other countries.



### INTEL END USER SOFTWARE LICENSE AGREEMENT IMPORTANT - READ BEFORE COPYING, INSTALLING OR USING.

LICENSE. Licensee has a license under Intel's copyrights to reproduce Intel's Software only in its unmodified and binary form, (with the accompanying documentation, the "Software") for Licensee's personal use only, and not commercial use, in connection with Intel-based products for which the Software has been provided, subject to the following conditions:

- (a) Licensee may not disclose, distribute or transfer any part of the Software, and You agree to prevent unauthorized copying of the Software.
- (b) Licensee may not reverse engineer, decompile, or disassemble the Software.
- (c) Licensee may not sublicense the Software.
- (d) The Software may contain the software and other intellectual property of third party suppliers, some of which may be identified in, and licensed in accordance with, an enclosed license.txt file or other text or file.
- (e) Intel has no obligation to provide any support, technical assistance or updates for the Software.

OWNERSHIP OF SOFTWARE AND COPYRIGHTS. Title to all copies of the Software remains with Intel or its licensors or suppliers. The Software is copyrighted and protected by the laws of the United States and other countries, and international treaty provisions. Licensee may not remove any copyright notices from the Software. Except as otherwise expressly provided above, Intel grants no express or implied right under Intel patents, copyrights, trademarks, or other intellectual property rights. Transfer of the license terminates Licensee's right to use the Software.

DISCLAIMER OF WARRANTY. The Software is provided "AS IS" without warranty of any kind, EITHER EXPRESS OR IMPLIED, INCLUDING WITHOUT LIMITATION, WARRANTIES OF MERCHANTABILITY OR FITNESS FOR ANY PARTICULAR PURPOSE.

LIMITATION OF LIABILITY. NEITHER INTEL NOR ITS LICENSORS OR SUPPLIERS WILL BE LIABLE FOR ANY LOSS OF PROFITS, LOSS OF USE, INTERRUPTION OF BUSINESS, OR INDIRECT, SPECIAL, INCIDENTAL, OR CONSEQUENTIAL DAMAGES.

ES OF ANY KIND WHETHER UNDER THIS AGREEMENT OR OTHERWISE, EVEN IF INTEL HAS BEEN ADVISED OF THE POSSIBILITY OF SUCH DAMAGES.

**LICENSE TO USE COMMENTS AND SUGGESTIONS.** This Agreement does NOT obligate Licensee to provide Intel with comments or suggestions regarding the Software. However, if Licensee provides Intel with comments or suggestions for the modification, correction, improvement or enhancement of (a) the Software or (b) Intel products or processes that work with the Software, Licensee grants to Intel a non-exclusive, worldwide, perpetual, irrevocable, transferable, royalty-free license, with the right to sublicense, under Licensee's intellectual property rights, to incorporate or otherwise utilize those comments and suggestions.

**TERMINATION OF THIS LICENSE.** Intel or the sublicensor may terminate this license at any time if Licensee is in breach of any of its terms or conditions. Upon termination, Licensee will immediately destroy or return to Intel all copies of the Software.

**THIRD PARTY BENEFICIARY.** Intel is an intended beneficiary of the End User License Agreement and has the right to enforce all of its terms.

**U.S. GOVERNMENT RESTRICTED RIGHTS.** The Software is a commercial item (as defined in 48 C.F.R. 2.101) consisting of commercial computer software and commercial computer software documentation (as those terms are used in 48 C.F.R. 12.212), consistent with 48 C.F.R. 12.212 and 48 C.F.R. 227.7202-1 through 227.7202-4. You will not provide the Software to the U.S. Government. Contractor or Manufacturer is Intel Corporation, 2200 Mission College Blvd., Santa Clara, CA 95054.

**EXPORT LAWS.** Licensee agrees that neither Licensee nor Licensee's subsidiaries will export/re-export the Software, directly or indirectly, to any country for which the U.S. Department of Commerce or any other agency or department of the U.S. Government or the foreign government from where it is shipping requires an export license, or other governmental approval, without first obtaining any such required license or approval. In the event the Software is exported from the U.S.A. or re-exported from a foreign destination by Licensee, Licensee will ensure that the distribution and export/re-export or import of the Software complies with all laws, regulations, orders, or other restrictions of the U.S. Export Administration Regulations and the appropriate foreign government.

**APPLICABLE LAWS.** This Agreement and any dispute arising out of or relating to it will be governed by the laws of the U.S.A. and Delaware, without regard to conflict of laws principles. The Parties to this Agreement exclude the application of the United Nations Convention on Contracts for the International Sale of Goods (1980). The state and federal courts sitting in Delaware, U.S.A. will have exclusive jurisdiction over any dispute arising out of or relating to this Agreement. The Parties consent to personal jurisdiction and venue in those courts. A Party that obtains a judgment against the other Party in the courts identified in this section may enforce that judgment in any court that has jurisdiction over the Parties.

Licensee's specific rights may vary from country to country.

## CE Warning

This device complies with directive 2014/53/EU issued by the Commission of the European Community.

This equipment complies with EU radiation exposure limits set forth for an uncontrolled environment.

This equipment should be installed and operated with minimum distance 20cm between the radiator & your body.

Operations in the 5.15-5.35GHz band are restricted to indoor usage only.

	AT	BE	BG	CH	CY	CZ	DE
	DK	EE	EL	ES	FI	FR	HR
	HU	IE	IS	IT	LI	LT	LU
	LV	MT	NL	NO	PL	PT	RO
	SE	SI	SK	TR			



Radio transmit power per transceiver type

Function	Frequency	Maximum Output Power (EIRP)
WiFi	2400-2483.5 MHz	18.5 + / -1.5 dbm
	5150-5250 MHz	21.5 + / -1.5 dbm
	5250-5350 MHz	18.5 + / -1.5 dbm (no TPC) 21.5 + / -1.5 dbm (TPC)
	5470-5725 MHz	25.5 + / -1.5 dbm (no TPC) 28.5 + / -1.5 dbm (TPC)
Bluetooth	2400-2483.5 MHz	8.5 + / -1.5 dbm

**ASRock Incorporation**  
Contains Wi-Fi module with Bluetooth

**Intel® Wi-Fi 3168**  
Model: 3168NGW

FCC ID: PD93168NG

IC: 1000M-3168NG

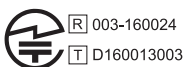

5.15~5.35GHz indoor use only



**ASRock Incorporation**  
Contains Wi-Fi module with Bluetooth

**Intel® Wi-Fi 9462**  
Model: 9462NGW

FCC ID: PD99462NG

IC: 1000M-9462NG

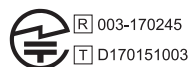

5.15~5.35GHz indoor use only



# Contents

<b>Chapter 1 Introduction</b>	<b>1</b>
1.1 Package Contents	1
1.2 Specifications	2
1.3 Motherboard Layout	6
1.4 I/O Panel	9
1.5 WiFi-802.11ac Module and ASRock WiFi 2.4/5 GHz Antennas	11
<b>Chapter 2 Installation</b>	<b>13</b>
2.1 Installing the CPU	14
2.2 Installing the CPU Fan and Heatsink	17
2.3 Installing Memory Modules (DIMM)	18
2.4 Expansion Slots (PCIe Slots)	20
2.5 Jumpers Setup	21
2.6 Onboard Headers and Connectors	22
2.7 Smart Button	27
2.8 Post Status Checker	28
2.9 CrossFireX™ and Quad CrossFireX™ Operation Guide	29
2.9.1 Installing Two CrossFireX™-Ready Graphics Cards	29
2.9.2 Driver Installation and Setup	31
2.10 M.2_SSD (NGFF) Module Installation Guide (M2_1)	32
2.11 M.2_SSD (NGFF) Module Installation Guide (M2_2)	35
2.12 M.2_SSD (NGFF) Module Installation Guide (M2_3)	38

2.12	M.2_SSD (NGFF) Module Installation Guide (M2_4)	42
------	---	----

## **Chapter 3 Software and Utilities Operation 45**

3.1	Installing Drivers	45
-----	--------------------	----

3.2	ASRock Motherboard Utility (A-Tuning)	46
-----	---------------------------------------	----

3.2.1	Installing ASRock Motherboard Utility (A-Tuning)	46
-------	--	----

3.2.2	Using ASRock Motherboard Utility (A-Tuning)	46
-------	---	----

3.3	ASRock Live Update & APP Shop	49
-----	-------------------------------	----

3.3.1	UI Overview	49
-------	-------------	----

3.3.2	Apps	50
-------	------	----

3.3.3	BIOS & Drivers	53
-------	----------------	----

3.3.4	Setting	54
-------	---------	----

3.4	ASRock Polychrome SYNC	55
-----	------------------------	----

## **Chapter 4 UEFI SETUP UTILITY 58**

4.1	Introduction	58
-----	--------------	----

4.2	EZ Mode	59
-----	---------	----

4.3	Advanced Mode	60
-----	---------------	----

4.3.1	UEFI Menu Bar	60
-------	---------------	----

4.3.2	Navigation Keys	61
-------	-----------------	----

4.4	Main Screen	62
-----	-------------	----

4.5	OC Tweaker Screen	63
-----	-------------------	----

4.6	Advanced Screen	79
-----	-----------------	----

4.6.1	CPU Configuration	80
-------	-------------------	----

4.6.2	Chipset Configuration	83
-------	-----------------------	----

4.6.3	Storage Configuration	86
-------	-----------------------	----

---

4.6.4	Intel(R) Thunderbolt	88
4.6.5	Super IO Configuration	89
4.6.6	ACPI Configuration	90
4.6.7	USB Configuration	91
4.6.8	Trusted Computing	92
4.7	Tools	94
4.8	Hardware Health Event Monitoring Screen	96
4.9	Security Screen	100
4.10	Boot Screen	101
4.11	Exit Screen	104



# Chapter 1 Introduction

Thank you for purchasing ASRock Z690-C/ac motherboard, a reliable motherboard produced under ASRock's consistently stringent quality control. It delivers excellent performance with robust design conforming to ASRock's commitment to quality and endurance.

In this documentation, Chapter 1 and 2 contains the introduction of the motherboard and step-by-step installation guides. Chapter 3 contains the operation guide of the software and utilities. Chapter 4 contains the configuration guide of the BIOS setup.



*Because the motherboard specifications and the BIOS software might be updated, the content of this documentation will be subject to change without notice. In case any modifications of this documentation occur, the updated version will be available on ASRock's website without further notice. If you require technical support related to this motherboard, please visit our website for specific information about the model you are using. You may find the latest VGA cards and CPU support list on ASRock's website as well. ASRock website <http://www.asrock.com>.*

## 1.1 Package Contents

- ASRock Z690-C/ac Motherboard (ATX Form Factor)
- 2 x Serial ATA (SATA) Data Cables (Optional)
- 2 x ASRock WiFi 2.4/5 GHz Antennas (Optional)
- 4 x Screws for M.2 Sockets (Optional)
- 1 x I/O Panel Shield

## 1.2 Specifications

- Platform**
- ATX Form Factor
  - Solid Capacitor design

- CPU**
- Supports 14<sup>th</sup>, 13<sup>th</sup> & 12<sup>th</sup> Gen Intel® Core™ Processors (LGA1700)
  - 9 Power Phase design
  - Supports Intel® Hybrid Technology
  - Supports Intel® Turbo Boost Max 3.0 Technology

- Chipset**
- Intel® Z690

- Memory**
- Dual Channel DDR4 Memory Technology
  - 4 x DDR4 DIMM Slots
  - Supports DDR4 non-ECC, un-buffered memory up to 5333+(OC)\*
  - \* Supports DDR4 3200 natively.
  - \* Please refer to Memory Support List on ASRock's website for more information. (<http://www.asrock.com/>)
  - Supports ECC UDIMM memory modules (operate in non-ECC mode)
  - Max. capacity of system memory: 128GB
  - Supports Intel® Extreme Memory Profile (XMP) 2.0

- Expansion Slot**
- 2 x PCIe x16 Slots (PCIe1/PCIe3: single at Gen5x16 (PCIe1); dual at Gen5x16 (PCIe1) / Gen4x4 (PCIe3))\*

- \* Supports NVMe SSD as boot disks
- 1 x PCIe Gen3x16 Slot (PCIe5: x1 mode)
- 2 x PCIe Gen3x1 Slots
- Supports AMD Quad CrossFireX™ and CrossFireX™
- 1 x M.2 Socket (Key E), supports type 2230 WiFi/BT PCIe WiFi module and Intel® CNVi (Integrated WiFi/BT)

- Graphics**
- Intel® UHD Graphics Built-in Visuals and the VGA outputs can be supported only with processors which are GPU integrated.
  - Intel® X<sup>c</sup> Graphics Architecture (Gen 12)

- Supports HDMI 2.1 TMDS Compatible with max. resolution up to 4K x 2K (4096x2160) @ 60Hz
- Supports HDCP 2.3 with HDMI 2.1 TMDS Compatible Port

**Audio**

- 7.1 CH HD Audio (Realtek ALC897 Audio Codec)
- Supports Surge Protection

**LAN**

- Gigabit LAN 10/100/1000 Mb/s
- Giga PHY Intel® I219V
- Supports Wake-On-LAN
- Supports Lightning/ESD Protection
- Supports Energy Efficient Ethernet 802.3az
- Supports PXE

**Wireless  
LAN**

- 802.11ac WiFi Module
- Supports IEEE 802.11a/b/g/n/ac
- Supports Dual-Band (2.4/5 GHz)
- Supports high speed wireless connections up to 433Mbps
- Supports Bluetooth + High speed class II

**Rear Panel  
I/O**

- 2 x Antenna Ports
- 1 x PS/2 Mouse/Keyboard Port
- 1 x HDMI Port
- 1 x USB 3.2 Gen2 Type-A Port (10 Gb/s) (ReDriver) (Supports ESD Protection)
- 1 x USB 3.2 Gen2 Type-C Port (10 Gb/s) (ReDriver) (Supports ESD Protection)
- 4 x USB 3.2 Gen1 Ports (Supports ESD Protection)
- 2 x USB 2.0 Ports (Supports ESD Protection)
- 1 x RJ-45 LAN Port with LED (ACT/LINK LED and SPEED LED)
- 1 x BIOS Flashback Button
- HD Audio Jacks: Line in / Front Speaker / Microphone

**Storage**

- 4 x SATA3 6.0 Gb/s Connectors
- 1 x Hyper M.2 Socket (M2\_1, Key M), supports type 2260/2280 PCIe Gen4x4 (64 Gb/s) mode\*
- 1 x Hyper M.2 Socket (M2\_2, Key M), supports type 2242/2260/2280 PCIe Gen4x4 (64 Gb/s) mode\*

- 1 x Hyper M.2 Socket (M2\_3, Key M), supports type 2260/2280/22110 SATA3 6.0 Gb/s & PCIe Gen4x4 (64 Gb/s) modes\*
- 1 x Ultra M.2 Socket (M2\_4, Key M), supports type 2280 PCIe Gen3x4 (32 Gb/s) mode\*
- \* Supports Intel® Optane™ Technology (M2\_2, M2\_3 and M2\_4 only)
- \* Supports Intel® Volume Management Device (VMD)
- \* Supports NVMe SSD as boot disks
- \* Supports ASRock U.2 Kit

## RAID

- Supports RAID 0, RAID 1, RAID 5 and RAID 10 for SATA storage devices
- Supports RAID 0, RAID 1 and RAID 5 for M.2 NVMe storage devices

## Connector

- 1 x SPI TPM Header
- 1 x Power LED and Speaker Header
- 1 x RGB LED Header
- \* Supports in total up to 12V/3A, 36W LED Strip
- 3 x Addressable LED Headers
- \* Support in total up to 5V/3A, 15W LED Strip
- 1 x CPU Fan Connector (4-pin)
- \* The CPU Fan Connector supports the CPU fan of maximum 1A (12W) fan power.
- 1 x CPU/Water Pump Fan Connector (4-pin) (Smart Fan Speed Control)
- \* The CPU/Water Pump Fan supports the water cooler fan of maximum 2A (24W) fan power.
- 4 x Chassis/Water Pump Fan Connectors (4-pin) (Smart Fan Speed Control)
- \* The Chassis/Water Pump Fan supports the water cooler fan of maximum 2A (24W) fan power.
- \* CPU\_FAN2/WP and CHA\_FAN1~4/WP can auto detect if 3-pin or 4-pin fan is in use.
- 1 x 24 pin ATX Power Connector
- 1 x 8 pin 12V Power Connector (Hi-Density Power Connector)
- 1 x 4 pin 12V Power Connector (Hi-Density Power Connector)

- 1 x Front Panel Audio Connector
- 1 x Thunderbolt AIC Connector (5-pin) (Supports ASRock Thunderbolt 4 AIC Card)
- 1 x USB 2.0 Header (Supports 2 USB 2.0 ports) (Supports ESD Protection)
- 2 x USB 3.2 Gen1 Headers (Support 4 USB 3.2 Gen1 ports) (ASMedia ASM1074 hub) (Supports ESD Protection)
- 1 x Front Panel Type C USB 3.2 Gen2x2 Header (20 Gb/s) (Supports ESD Protection)

### BIOS Feature

- AMI UEFI Legal BIOS with multilingual GUI support
- ACPI 6.0 Compliant wake up events
- SMBIOS 2.7 Support
- CPU Core/Cache, CPU GT, DRAM, VCCIN AUX, +1.05V PROC, +1.8V PROC, +0.82V PCH , +1.05V PCH Voltage Multi-adjustment

### Hardware Monitor

- Fan Tachometer: CPU, CPU/Water Pump, Chassis/Water Pump Fans
- Quiet Fan (Auto adjust chassis fan speed by CPU temperature): CPU, CPU/Water Pump, Chassis/Water Pump Fans
- Fan Multi-Speed Control: CPU, CPU/Water Pump, Chassis/Water Pump Fans
- Voltage monitoring: CPU Vcore, PCH, DRAM, VCCIN AUX, +1.05V PROC, +1.8V PROC, +0.82V PCH, +12V, +5V, +3.3V

### OS

- Microsoft® Windows® 10 64-bit / 11 64-bit

### Certifica- tions

- FCC, CE
- ErP/EuP ready (ErP/EuP ready power supply is required)
- CEC Tier II ready

\* For detailed product information, please visit our website: <http://www.asrock.com>



Please realize that there is a certain risk involved with overclocking, including adjusting the setting in the BIOS, applying Untied Overclocking Technology, or using third-party overclocking tools. Overclocking may affect your system's stability, or even cause damage to the components and devices of your system. It should be done at your own risk and expense. We are not responsible for possible damage caused by overclocking.

# 1.3 Motherboard Layout

## Top Side View

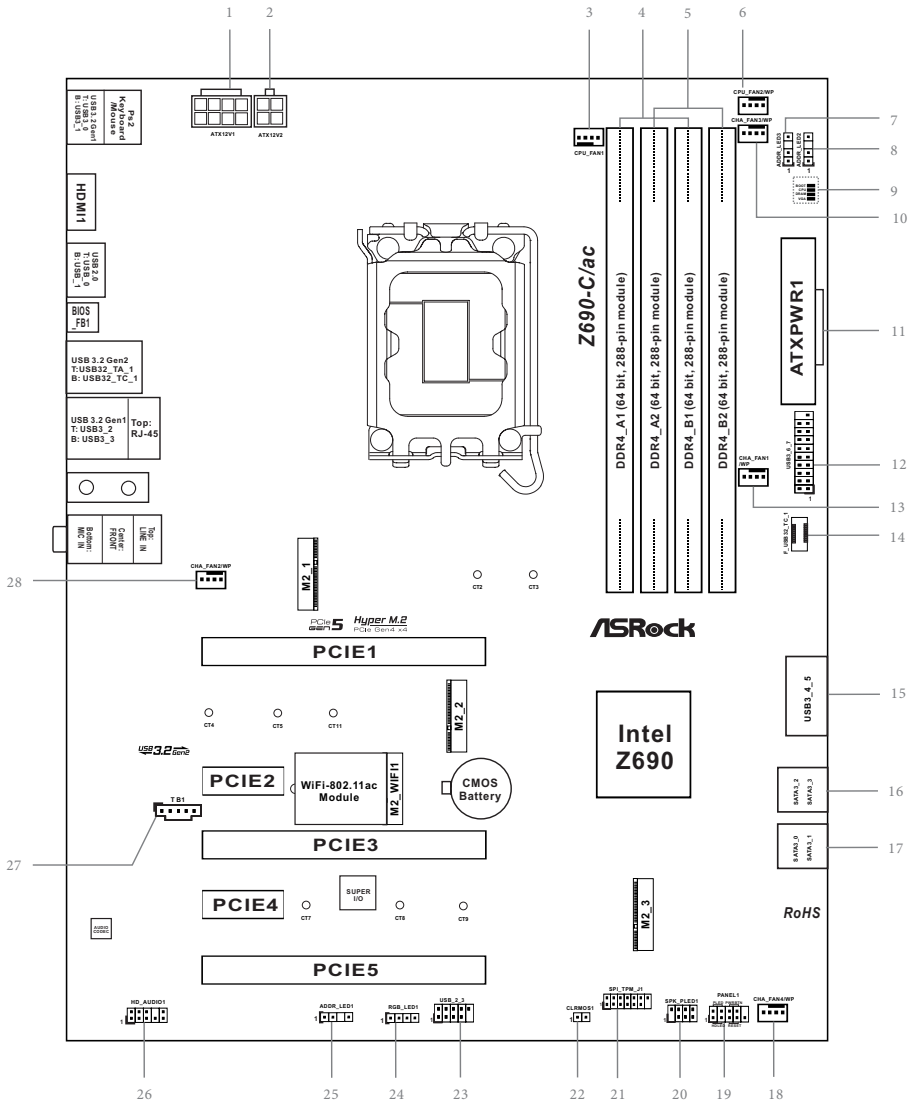

## Back Side View

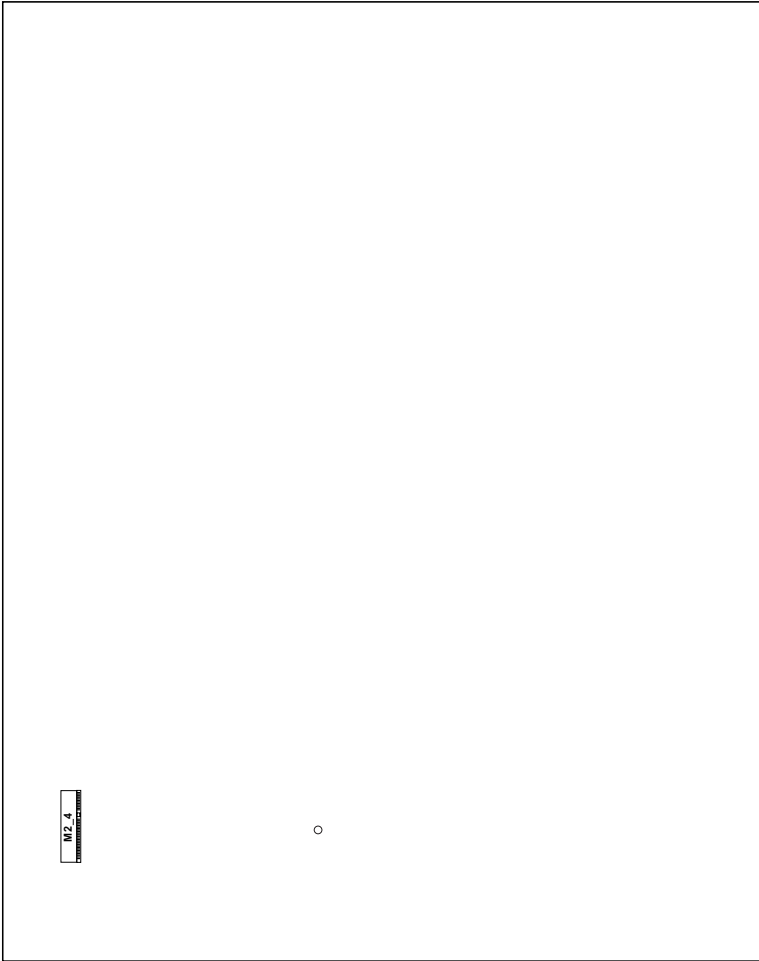

No.	Description
1	8 pin 12V Power Connector (ATX12V1)
2	4 pin 12V Power Connector (ATX12V2)
3	CPU Fan Connector (CPU_FAN1)
4	2 x 288-pin DDR4 DIMM Slots (DDR4_A1, DDR4_B1)
5	2 x 288-pin DDR4 DIMM Slots (DDR4_A2, DDR4_B2)
6	CPU/Water Pump Fan Connector (CPU_FAN2/WP)
7	Addressable LED Header (ADDR_LED3)
8	Addressable LED Header (ADDR_LED2)
9	Post Status Checker (PSC)
10	Chassis/Water Pump Fan Connector (CHA_FAN3/WP)
11	ATX Power Connector (ATXPWR1)
12	USB 3.2 Gen1 Header (USB3_6_7)
13	Chassis/Water Pump Fan Connector (CHA_FAN1/WP)
14	Front Panel Type C USB 3.2 Gen2x2 Header (F_USB32_TC_1)
15	USB 3.2 Gen1 Header (USB3_4_5)
16	SATA3 Connectors (SATA3_2)(Upper), (SATA3_3)(Lower)
17	SATA3 Connectors (SATA3_0)(Upper), (SATA3_1)(Lower)
18	Chassis/Water Pump Fan Connector (CHA_FAN4/WP)
19	System Panel Header (PANEL1)
20	Power LED and Speaker Header (SPK_PLED1)
21	SPI TPM Header (SPI_TPM_J1)
22	Clear CMOS Jumper (CLRMOSS1)
23	USB 2.0 Header (USB_2_3)
24	RGB LED Header (RGB_LED1)
25	Addressable LED Header (ADDR_LED1)
26	Front Panel Audio Header (HD_AUDIO1)
27	5-pin Thunderbolt AIC Connector (TB1)
28	Chassis/Water Pump Fan Connector (CHA_FAN2/WP)



## 1.4 I/O Panel

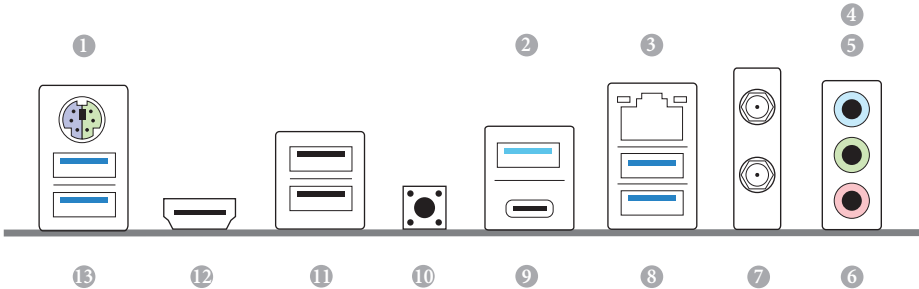

No.	Description	No.	Description
1	PS/2 Mouse/Keyboard Port	8	USB 3.2 Gen1 Ports (USB3_2_3)
2	USB 3.2 Gen2 Type-A Port (USB32_TA_1)	9	USB 3.2 Gen2 Type-C Port (USB32_TC_1)
3	LAN RJ-45 Port*	10	BIOS Flashback Button
4	Line In (Light Blue)**	11	USB 2.0 Ports (USB_0_1)
5	Front Speaker (Lime)**	12	HDMI Port
6	Microphone (Pink)**	13	USB 3.2 Gen1 Ports (USB3_0_1)
7	Antenna Ports		

\* There are two LEDs on each LAN port. Please refer to the table below for the LAN port LED indications.

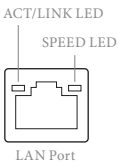

Activity / Link LED		Speed LED	
Status	Description	Status	Description
Off	No Link	Off	10Mbps connection
Blinking	Data Activity	Orange	100Mbps connection
On	Link	Green	1Gbps connection

**\*\* Function of the Audio Ports in 7.1-channel Configuration:**

<b>Port</b>	<b>Function</b>
Light Blue (Rear panel)	Rear Speaker Out
Lime (Rear panel)	Front Speaker Out
Pink (Rear panel)	Central /Subwoofer Speaker Out
Lime (Front panel)	Side Speaker Out

## 1.5 WiFi-802.11ac Module and ASRock WiFi 2.4/5 GHz Antennas

### WiFi-802.11ac + BT Module

This motherboard comes with an exclusive WiFi 802.11 a/b/g/n/ac + BT module that offers support for WiFi 802.11 a/b/g/n/ac connectivity standards and Bluetooth. WiFi + BT module is an easy-to-use wireless local area network (WLAN) adapter to support WiFi + BT. Bluetooth standard features Smart Ready technology that adds a whole new class of functionality into the mobile devices. BT also includes Low Energy Technology and ensures extraordinary low power consumption for PCs.

\* The transmission speed may vary according to the environment.

## WiFi Antennas Installation Guide



### **Step 1**

Prepare the WiFi 2.4/5 GHz Antennas that come with the package.

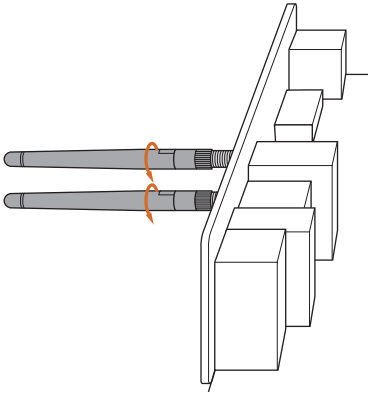

### **Step 2**

Connect the two WiFi 2.4/5 GHz Antennas to the antenna connectors. Turn the antenna clockwise until it is securely connected.

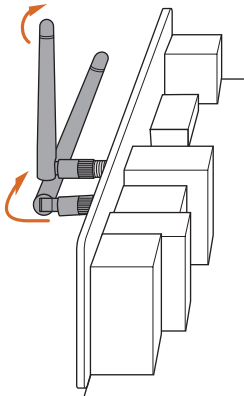

### **Step 3**

Set the WiFi 2.4/5 GHz Antenna as shown in the illustration.

\*You may need to adjust the direction of the antenna for a stronger signal.

## Chapter 2 Installation

This is an ATX form factor motherboard. Before you install the motherboard, study the configuration of your chassis to ensure that the motherboard fits into it.

### Pre-installation Precautions

Take note of the following precautions before you install motherboard components or change any motherboard settings.

- Make sure to unplug the power cord before installing or removing the motherboard components. Failure to do so may cause physical injuries and damages to motherboard components.
- In order to avoid damage from static electricity to the motherboard's components, NEVER place your motherboard directly on a carpet. Also remember to use a grounded wrist strap or touch a safety grounded object before you handle the components.
- Hold components by the edges and do not touch the ICs.
- Whenever you uninstall any components, place them on a grounded anti-static pad or in the bag that comes with the components.
- When placing screws to secure the motherboard to the chassis, please do not over-tighten the screws! Doing so may damage the motherboard.

## 2.1 Installing the CPU



1. Before you insert the 1700-Pin CPU into the socket, please check if the **PnP cap** is on the socket, if the CPU surface is unclean, or if there are any **bent pins** in the socket. Do not force to insert the CPU into the socket if above situation is found. Otherwise, the CPU will be seriously damaged.
2. Unplug all power cables before installing the CPU.

1

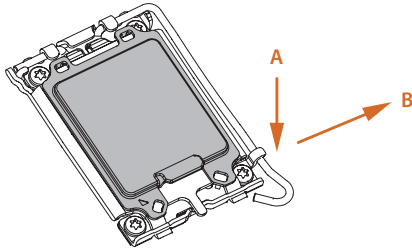

2

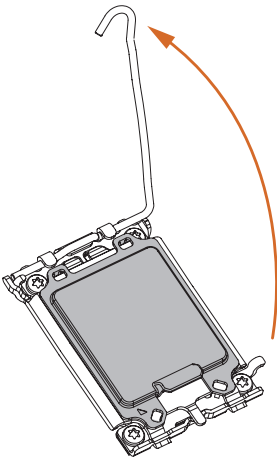

3

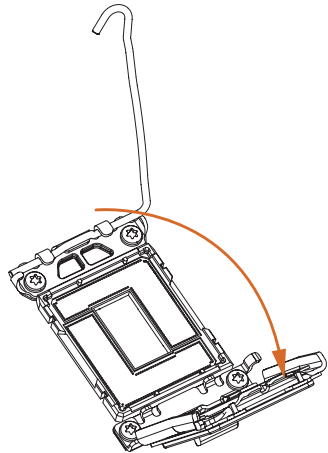

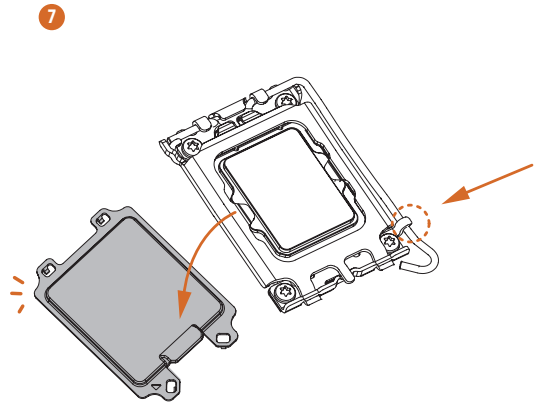
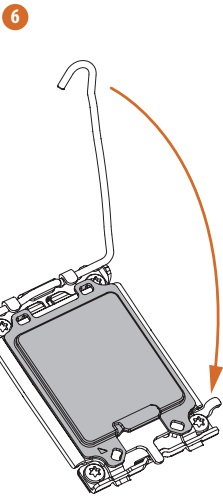
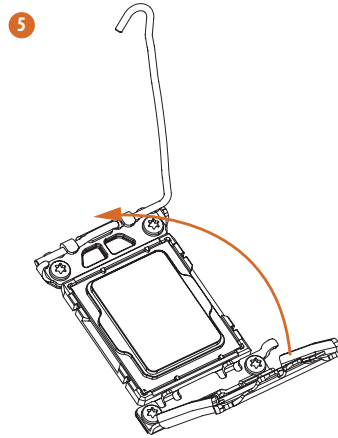
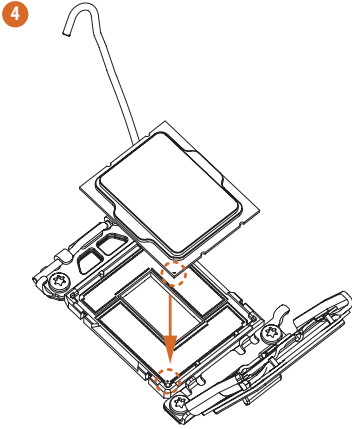



*Please save and replace the cover if the processor is removed. The cover must be placed if you wish to return the motherboard for after service.*

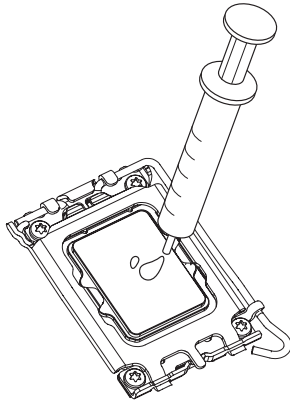
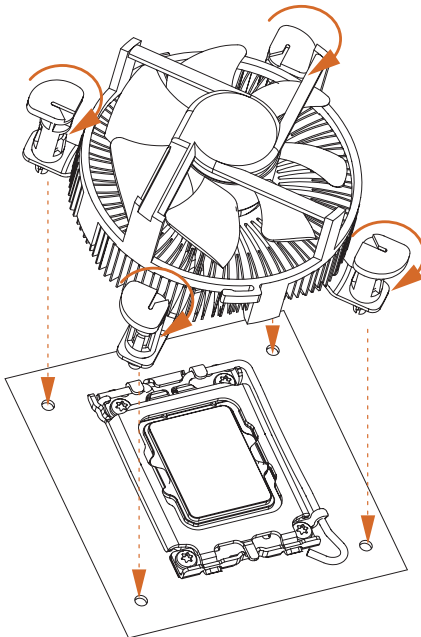
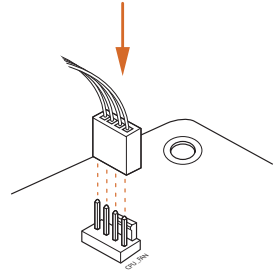

## 2.2 Installing the CPU Fan and Heatsink

**1****2**

## 2.3 Installing Memory Modules (DIMM)

This motherboard provides four 288-pin DDR4 (Double Data Rate 4) DIMM slots, and supports Dual Channel Memory Technology.



1. For dual channel configuration, you always need to install identical (the same brand, speed, size and chip-type) DDR4 DIMM pairs.
2. It is unable to activate Dual Channel Memory Technology with only one or three memory module installed.
3. It is not allowed to install a DDR, DDR2 or DDR3 memory module into a DDR4 slot; otherwise, this motherboard and DIMM may be damaged.

### Dual Channel Memory Configuration

Priority	DDR4_A1	DDR4_A2	DDR4_B1	DDR4_B2
1		Populated		Populated
2	Populated	Populated	Populated	Populated



*The DIMM only fits in one correct orientation. It will cause permanent damage to the motherboard and the DIMM if you force the DIMM into the slot at incorrect orientation.*

1

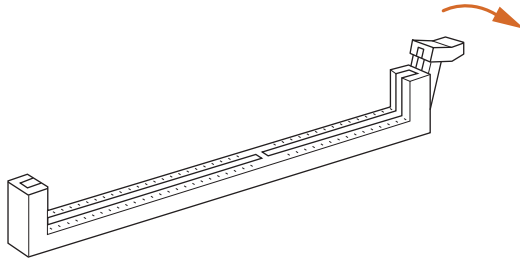

2

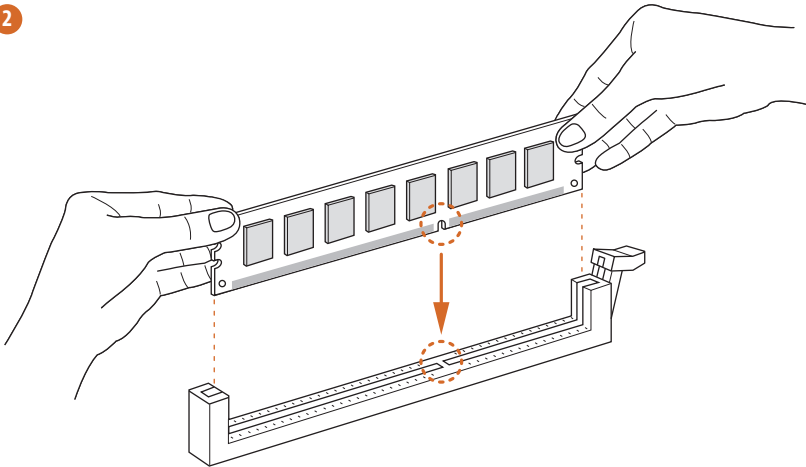

3

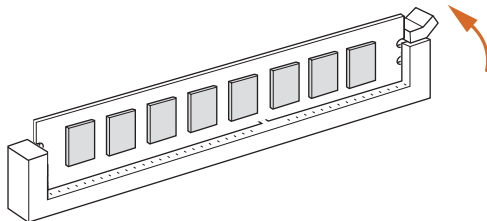

## 2.4 Expansion Slots (PCIe Slots)

There are 5 PCIe slots on the motherboard.



*Before installing an expansion card, please make sure that the power supply is switched off or the power cord is unplugged. Please read the documentation of the expansion card and make necessary hardware settings for the card before you start the installation.*

### PCIe slots:

PCIe1 (PCIe 5.0 x16 slot) is used for PCIe x16 lane width graphics cards.

PCIe2 (PCIe 3.0 x1 slot) is used for PCIe x1 lane width cards.

PCIe3 (PCIe 4.0 x16 slot) is used for PCIe x4 lane width graphics cards.

PCIe4 (PCIe 3.0 x1 slot) is used for PCIe x1 lane width cards.

PCIe5 (PCIe 3.0 x16 slot) is used for PCIe x1 lane width cards.

### PCIe Slot Configurations

	PCIe1	PCIe3
<b>Single Graphics Card</b>	Gen5x16	N/A
<b>Two Graphics Cards in CrossFireX™ Mode</b>	Gen5x16	Gen4x4



*For a better thermal environment, please connect a chassis fan to the motherboard's chassis fan connector (CHA\_FAN1/WP, CHA\_FAN2/WP, CHA\_FAN3/WP or CHA\_FAN4/WP) when using multiple graphics cards.*

## 2.5 Jumpers Setup

The illustration shows how jumpers are setup. When the jumper cap is placed on the pins, the jumper is “Short”. If no jumper cap is placed on the pins, the jumper is “Open”.

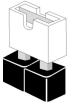

Short



Open

---

Clear CMOS Jumper  
(CLRMOSE1)  
(see p.6, No. 22)



2-pin Jumper

---

CLRMOSE1 allows you to clear the data in CMOS. To clear and reset the system parameters to default setup, please turn off the computer and unplug the power cord from the power supply. After waiting for 15 seconds, use a jumper cap to short the pins on CLRMOSE1 for 5 seconds. However, please do not clear the CMOS right after you update the BIOS. If you need to clear the CMOS when you just finish updating the BIOS, you must boot up the system first, and then shut it down before you do the clear-CMOS action. Please be noted that the password, date, time, and user default profile will be cleared only if the CMOS battery is removed. Please remember to remove the jumper cap after clearing the CMOS.

## 2.6 Onboard Headers and Connectors



Onboard headers and connectors are NOT jumpers. Do NOT place jumper caps over these headers and connectors. Placing jumper caps over the headers and connectors will cause permanent damage to the motherboard.

System Panel Header  
(9-pin PANEL1)  
(see p.6, No. 19)

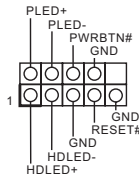

Connect the power button, reset button and system status indicator on the chassis to this header according to the pin assignments below. Note the positive and negative pins before connecting the cables.



### **PWRBTN (Power Button):**

Connect to the power button on the chassis front panel. You may configure the way to turn off your system using the power button.

### **RESET (Reset Button):**

Connect to the reset button on the chassis front panel. Press the reset button to restart the computer if the computer freezes and fails to perform a normal restart.

### **PLED (System Power LED):**

Connect to the power status indicator on the chassis front panel. The LED is on when the system is operating. The LED keeps blinking when the system is in S1/S3 sleep state. The LED is off when the system is in S4 sleep state or powered off (S5).

### **HDLED (Hard Drive Activity LED):**

Connect to the hard drive activity LED on the chassis front panel. The LED is on when the hard drive is reading or writing data.

The front panel design may differ by chassis. A front panel module mainly consists of power button, reset button, power LED, hard drive activity LED, speaker and etc. When connecting your chassis front panel module to this header, make sure the wire assignments and the pin assignments are matched correctly.

Power LED and Speaker  
Header  
(7-pin SPK\_PLED1)  
(see p.6, No. 20)

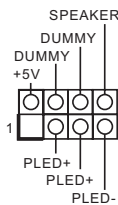

Please connect the chassis power LED and the chassis speaker to this header.

Serial ATA3 Connectors

Right-Angle:

- (SATA3\_0: see p.6, No. 17)(Upper)
- (SATA3\_1: see p.6, No. 17)(Lower)
- (SATA3\_2: see p.6, No. 16)(Upper)
- (SATA3\_3: see p.6, No. 16)(Lower)



These four SATA3 connectors support SATA data cables for internal storage devices with up to 6.0 Gb/s data transfer rate.

- USB 2.0 Header (9-pin USB\_2\_3) (see p.6, No. 23)

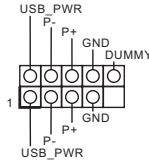

There is a USB 2.0 header on this motherboard. This USB 2.0 header can support two ports.

USB 3.2 Gen1 Headers

Vertical:

- (19-pin USB3\_6\_7) (see p.6, No. 12)

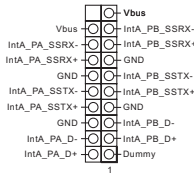

There are two headers on this motherboard. Each USB 3.2 Gen1 header can support two ports.

Right-Angle:

- (19-pin USB3\_4\_5) (see p.6, No. 15)

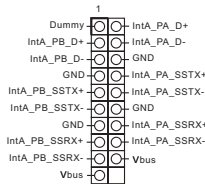

- Front Panel Type C USB 3.2 Gen2x2 Header (20-pin F\_USB32\_TC\_1) (see p.6, No. 14)

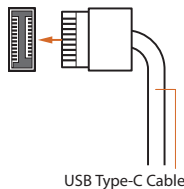

There is one Front Panel Type C USB 3.2 Gen2x2 Header on this motherboard. This header is used for connecting a USB 3.2 Gen2x2 module for additional USB 3.2 Gen2x2 ports.

**Front Panel Audio Header**  
 (9-pin HD\_AUDIO1)  
 (see p.6, No. 26)

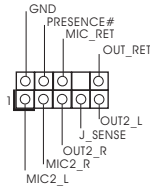

This header is for connecting audio devices to the front audio panel.



1. High Definition Audio supports Jack Sensing, but the panel wire on the chassis must support HDA to function correctly. Please follow the instructions in our manual and chassis manual to install your system.
2. If you use an AC'97 audio panel, please install it to the front panel audio header by the steps below:
  - A. Connect Mic\_IN (MIC) to MIC2\_L.
  - B. Connect Audio\_R (RIN) to OUT2\_R and Audio\_L (LIN) to OUT2\_L.
  - C. Connect Ground (GND) to Ground (GND).
  - D. MIC\_RET and OUT\_RET are for the HD audio panel only. You don't need to connect them for the AC'97 audio panel.
  - E. To activate the front mic, go to the "FrontMic" Tab in the Realtek Control panel and adjust "Recording Volume".

**Chassis/Water Pump Fan Connectors**  
 (4-pin CHA\_FAN1/WP)  
 (see p.6, No. 13)  
 (4-pin CHA\_FAN2/WP)  
 (see p.6, No. 28)  
 (4-pin CHA\_FAN3/WP)  
 (see p.6, No. 10)  
 (4-pin CHA\_FAN4/WP)  
 (see p.6, No. 18)

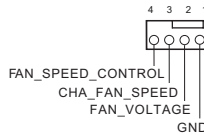

This motherboard provides four 4-Pin water cooling chassis fan connectors. If you plan to connect a 3-Pin chassis water cooler fan, please connect it to Pin 1-3.

**CPU Fan Connector**  
 (4-pin CPU\_FAN1)  
 (see p.6, No. 3)

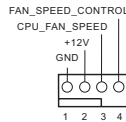

This motherboard provides a 4-Pin CPU fan (Quiet Fan) connector. If you plan to connect a 3-Pin CPU fan, please connect it to Pin 1-3.



CPU/Water Pump Fan  
Connector  
(4-pin CPU\_FAN2/WP)  
(see p.6, No. 6)

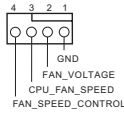

This motherboard provides a 4-Pin water cooling CPU fan connector. If you plan to connect a 3-Pin CPU water cooler fan, please connect it to Pin 1-3.

ATX Power Connector  
(24-pin ATXPWR1)  
(see p.6, No. 11)

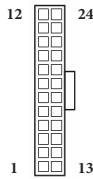

This motherboard provides a 24-pin ATX power connector. To use a 20-pin ATX power supply, please plug it along Pin 1 and Pin 13.

ATX 12V Power  
Connector  
(8-pin ATX12V1)  
(see p.6, No. 1)

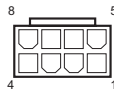

This motherboard provides an 8-pin ATX 12V power connector. To use a 4-pin ATX power supply, please plug it along Pin 1 and Pin 5.

**\*Warning: Please make sure that the power cable connected is for the CPU and not the graphics card. Do not plug the PCIe power cable to this connector.**

ATX 12V Power  
Connector  
(4-pin ATX12V2)  
(see p.6, No. 2)



Please connect an ATX 12V power supply to this connector.

\*The power supply plug fits into this connector in only one orientation.

\*Connecting an ATX 12V 4-pin cable to ATX12V2 is optional.

\*For advanced overclocking we suggest using this connector together with ATX12V1.

SPI TPM Header  
(13-pin SPI\_TPM\_J1)  
(see p.6, No. 21)

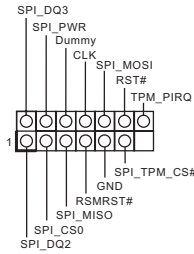

This connector supports SPI Trusted Platform Module (TPM) system, which can securely store keys, digital certificates, passwords, and data. A TPM system also helps enhance network security, protects digital identities, and ensures platform integrity.

Thunderbolt AIC Connector  
(5-pin TB1)  
(see p.6, No. 27)



Please connect a Thunderbolt™ add-in card (AIC) to this connector via the GPIO cable.  
\*Please install the Thunderbolt™ AIC card to PCIE3 (default slot).

RGB LED Header  
(4-pin RGB\_LED1)  
(see p.6, No. 24)



This RGB header is used to connect RGB LED extension cable which allow users to choose from various LED lighting effects.

**Caution: Never install the RGB LED cable in the wrong orientation; otherwise, the cable may be damaged.**

\*Please refer to page 55 for further instructions on this header.

Addressable LED Headers  
(3-pin ADDR\_LED1)  
(see p.6, No. 25)

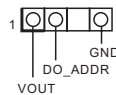

These headers are used to connect Addressable LED extension cables which allow users to choose from various LED lighting effects.

**Caution: Never install the Addressable LED cable in the wrong orientation; otherwise, the cable may be damaged.**

\*Please refer to page 56 for further instructions on this header.

(3-pin ADDR\_LED2)  
(see p.6, No. 8)  
(3-pin ADDR\_LED3)  
(see p.6, No. 7)

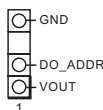

## 2.7 Smart Button

The motherboard has a smart button: BIOS Flashback Button, allowing users to flash the BIOS.

BIOS Flashback Button  
(BIOS\_FB1)  
(see p.9, No. 10)



BIOS Flashback Switch allows users to flash the BIOS.

ASRock BIOS Flashback feature allows you to update BIOS without powering on the system, even without CPU.



*Before using the BIOS Flashback function, please suspend BitLocker and any encryption or security relying on the TPM. Make sure that you have already stored and backup-ed the recovery key. If the recovery key is missing while encryption is active, the data will stay encrypted and the system will not boot into the operating system. It is recommended to disable fTPM before updating the BIOS. Otherwise an unpredictable failure may occur.*

To use the USB BIOS Flashback function, Please follow the steps below.

1. Download the latest BIOS file from ASRock's website : <http://www.asrock.com>.
2. Copy the BIOS file to your USB flash drive. Please make sure the file system of your USB flash drive must be FAT32.
3. Extract BIOS file from the zip file.
4. Rename the file to "creative.rom" and save it to the root directory of X: USB flash drive.
5. Plug the 24 pin power connector to the motherboard. Then turn on the power supply's AC switch.

\*There is no need to power on the system.

6. Then plug your USB drive to the USB BIOS Flashback port.
7. Press the BIOS Flashback Switch for about three seconds. Then the LED starts to blink.
8. Wait until the LED stops blinking, indicating that BIOS flashing has been completed.

\*If the LED light turns solid green, this means that the BIOS Flashback is not operating properly. Please make sure that you plug the USB drive to the USB BIOS Flashback port.

\*\*If the LED does not light up at all then please disconnect power from the system and remove/disconnect the CMOS battery from the motherboard for several minutes. Reconnect power and battery and try again.

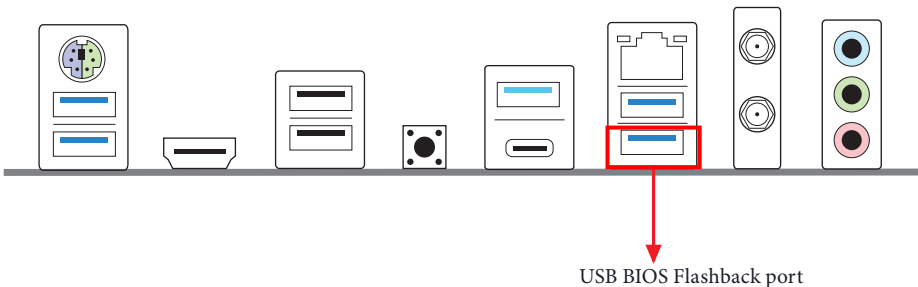

---

## 2.8 Post Status Checker

Post Status Checker (PSC) diagnoses the computer when users power on the machine. It emits a red light to indicate whether the CPU, memory, VGA or storage is dysfunctional. The lights go off if the four mentioned above are functioning normally.

## 2.9 CrossFireX™ and Quad CrossFireX™ Operation Guide

This motherboard supports CrossFireX™ and Quad CrossFireX™ that allows you to install up to three identical PCI Express x16 graphics cards.



1. You should only use identical CrossFireX™-ready graphics cards that are AMD certified.
2. Make sure that your graphics card driver supports AMD CrossFireX™ technology. Download the drivers from the AMD's website: [www.amd.com](http://www.amd.com)
3. Make sure that your power supply unit (PSU) can provide at least the minimum power your system requires. It is recommended to use a AMD certified PSU. Please refer to the AMD's website for details.
4. If you pair a 12-pipe CrossFireX™ Edition card with a 16-pipe card, both cards will operate as 12-pipe cards while in CrossFireX™ mode.
5. Different CrossFireX™ cards may require different methods to enable CrossFireX™. Please refer to AMD graphics card manuals for detailed installation guide.

### 2.9.1 Installing Two CrossFireX™-Ready Graphics Cards

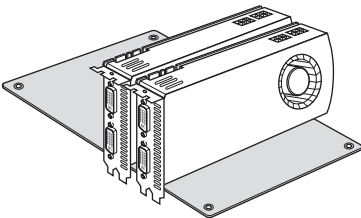

#### Step 1

Insert one graphics card into PCIe1 slot and the other graphics card to PCIe3 slot. Make sure that the cards are properly seated on the slots.



CrossFire Bridge

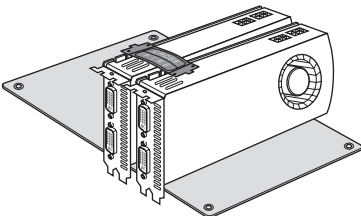

#### Step 2

Connect two graphics cards by installing a CrossFire Bridge on the CrossFire Bridge Interconnects on the top of the graphics cards. (The CrossFire Bridge is provided with the graphics card you purchase, not bundled with this motherboard. Please refer to your graphics card vendor for details.)

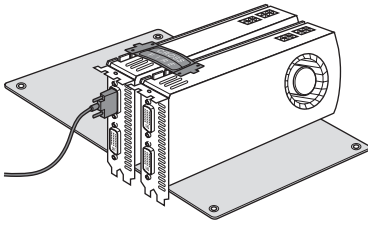

**Step 3**

Connect a VGA/DVI/DP/HDMI cable from the monitor to the corresponding port on the graphics card installed to the PCIE1 slot.

## 2.9.2 Driver Installation and Setup

### Step 1

Power on your computer and boot into OS.

### Step 2

Remove the AMD drivers if you have any VGA drivers installed in your system.



*The Catalyst Uninstaller is an optional download. We recommend using this utility to uninstall any previously installed Catalyst drivers prior to installation. Please check AMD's website for AMD driver updates.*

### Step 3

Install the required drivers and CATALYST Control Center then restart your computer. Please check AMD's website for details.



AMD Catalyst Control Center

### Step 4

Double-click the **AMD Catalyst Control Center** icon in the Windows' system tray.

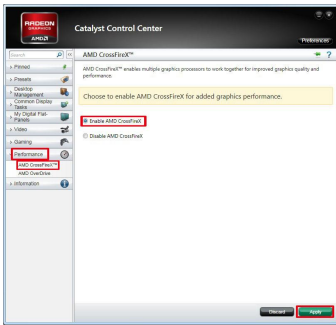

### Step 5

In the left pane, click **Performance** and then **AMD CrossFireX™**. Then select **Enable AMD CrossFireX** and click **Apply**. Select the GPU number according to your graphics card and click **Apply**.

## 2.10 M.2\_SSD (NGFF) Module Installation Guide (M2\_1)

The M.2, also known as the Next Generation Form Factor (NGFF), is a small size and versatile card edge connector that aims to replace mPCIe and mSATA. The Hyper M.2 Socket (M2\_1, Key M) supports type 2260/2280 PCIe Gen4x4 (64 Gb/s) mode.

### Installing the M.2\_SSD (NGFF) Module

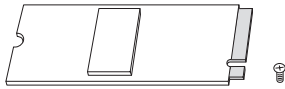

#### Step 1

Prepare a M.2\_SSD (NGFF) module and the screw.

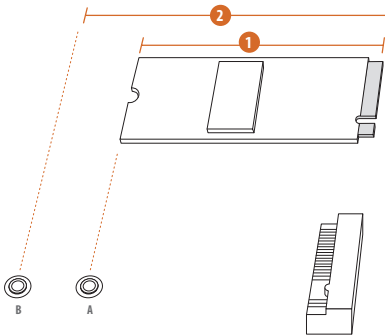

#### Step 2

Depending on the PCB type and length of your M.2\_SSD (NGFF) module, find the corresponding nut location to be used.

No.	1	2
Nut Location	A	B
PCB Length	6cm	8cm
Module Type	Type 2260	Type 2280

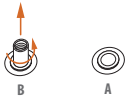

**Step 3**

Move the standoff based on the module type and length. The standoff is placed at the nut location B by default. Skip Step 3 and 4 and go straight to Step 5 if you are going to use the default nut. Otherwise, release the standoff by hand.

**Step 4**

Peel off the yellow protective film on the nut to be used. Hand tighten the standoff into the desired nut location on the motherboard.

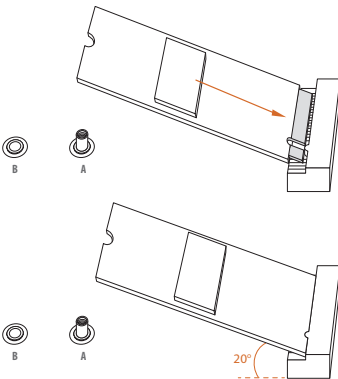
**Step 5**

Gently insert the M.2 (NGFF) SSD module into the M.2 slot. Please be aware that the M.2 (NGFF) SSD module only fits in one orientation.

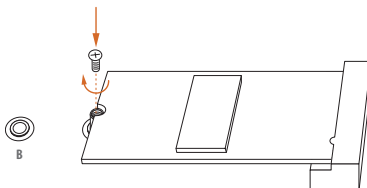
**Step 6**

Tighten the screw with a screwdriver to secure the module into place. Please do not overtighten the screw as this might damage the module.

## M.2\_SSD (NGFF) Module Support List (M2\_1)

Vendor	Interface	P/N
ADATA	PCIe3 x4	ASX7000NP-128GT-C
ADATA	PCIe3 x4	ASX8000NP-256GM-C
ADATA	PCIe3 x4	ASX7000NP-256GT-C
ADATA	PCIe3 x4	ASX8000NP-512GM-C
ADATA	PCIe3 x4	ASX7000NP-512GT-C
Apacer	PCIe3 x4	AP240GZ280
Corsair	PCIe3 x4	CSSD-F240GBMP500
Intel	PCIe3 x4	SSDPEKKF256G7
Intel	PCIe3 x4	SSDPEKKF512G7
Kingston	PCIe3 x4	SKC1000/480G
Kingston	PCIe2 x4	SH2280S3/480G
OCZ	PCIe3 x4	RVD400 -M2280-512G (NVME)
PATRIOT	PCIe3 x4	PH240GPM280SSDR NVME
Plextor	PCIe3 x4	PX-128M8PeG
Plextor	PCIe3 x4	PX-1TM8PeG
Plextor	PCIe3 x4	PX-256M8PeG
Plextor	PCIe3 x4	PX-512M8PeG
Plextor	PCIe	PX-G256M6e
Plextor	PCIe	PX-G512M6e
Samsung	PCIe3 x4	SM961 MZVPW128HEGM (NVM)
Samsung	PCIe3 x4	PM961 MZVLW128HEGR (NVME)
Samsung	PCIe3 x4	960 EVO (MZ-V6E250) (NVME)
Samsung	PCIe3 x4	960 EVO (MZ-V6E250BW) (NVME)
Samsung	PCIe3 x4	SM951 (NVME)
Samsung	PCIe3 x4	SM951 (MZHPV256HDGL)
Samsung	PCIe3 x4	SM951 (MZHPV512HDGL)
Samsung	PCIe3 x4	SM951 (NVME)
Samsung	PCIe x4	XP941-512G (MZHPU512HCGL)
SanDisk	PCIe	SD6PP4M-128G
SanDisk	PCIe	SD6PP4M-256G
TEAM	PCIe3 x4	TM8FP2240G0C101
TEAM	PCIe3 x4	TM8FP2480GC110
WD	PCIe3 x4	WDS256G1X0C-00ENX0 (NVME)
WD	PCIe3 x4	WDS512G1X0C-00ENX0 (NVME)

For the latest updates of M.2\_SSD (NFGG) module support list, please visit our website for details: <http://www.asrock.com>

## 2.11 M.2\_SSD (NGFF) Module Installation Guide (M2\_2)

The M.2, also known as the Next Generation Form Factor (NGFF), is a small size and versatile card edge connector that aims to replace mPCIe and mSATA. The Hyper M.2 Socket (M2\_2, Key M) supports type 2242/2260/2280 PCIe Gen4x4 (64 Gb/s) mode.

### Installing the M.2\_SSD (NGFF) Module

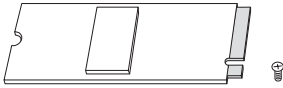

#### Step 1

Prepare a M.2\_SSD (NGFF) module and the screw.

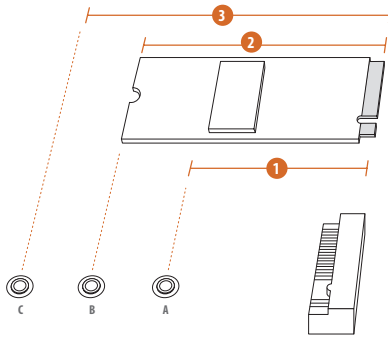

#### Step 2

Depending on the PCB type and length of your M.2\_SSD (NGFF) module, find the corresponding nut location to be used.

No.	1	2	3
Nut Location	A	B	C
PCB Length	4.2cm	6cm	8cm
Module Type	Type2242	Type2260	Type 2280

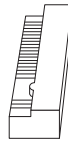

### Step 3

Move the standoff based on the module type and length. The standoff is placed at the nut location C by default. Skip Step 3 and 4 and go straight to Step 5 if you are going to use the default nut. Otherwise, release the standoff by hand.

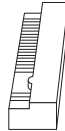

### Step 4

Peel off the yellow protective film on the nut to be used. Hand tighten the standoff into the desired nut location on the motherboard.

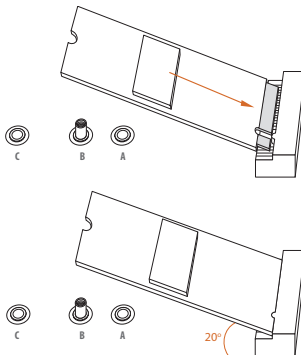

### Step 5

Gently insert the M.2 (NGFF) SSD module into the M.2 slot. Please be aware that the M.2 (NGFF) SSD module only fits in one orientation.

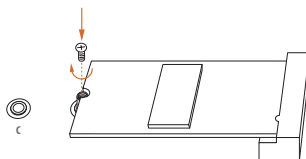

### Step 6

Tighten the screw with a screwdriver to secure the module into place. Please do not overtighten the screw as this might damage the module.

## M.2\_SSD (NGFF) Module Support List (M2\_2)

Vendor	Interface	P/N
ADATA	PCIe3 x4	ASX7000NP-128GT-C
ADATA	PCIe3 x4	ASX8000NP-256GM-C
ADATA	PCIe3 x4	ASX7000NP-256GT-C
ADATA	PCIe3 x4	ASX8000NP-512GM-C
ADATA	PCIe3 x4	ASX7000NP-512GT-C
Apacer	PCIe3 x4	AP240GZ280
Corsair	PCIe3 x4	CSSD-F240GBMP500
Intel	PCIe3 x4	SSDPEKKF256G7
Intel	PCIe3 x4	SSDPEKKF512G7
Kingston	PCIe3 x4	SKC1000/480G
Kingston	PCIe2 x4	SH2280S3/480G
OCZ	PCIe3 x4	RVD400 -M2280-512G (NVME)
PATRIOT	PCIe3 x4	PH240GPM280SSDR NVME
Plextor	PCIe3 x4	PX-128M8PeG
Plextor	PCIe3 x4	PX-1TM8PeG
Plextor	PCIe3 x4	PX-256M8PeG
Plextor	PCIe3 x4	PX-512M8PeG
Plextor	PCIe	PX-G256M6e
Plextor	PCIe	PX-G512M6e
Samsung	PCIe3 x4	SM961 MZVPW128HEGM (NVM)
Samsung	PCIe3 x4	PM961 MZVLW128HEGR (NVME)
Samsung	PCIe3 x4	960 EVO (MZ-V6E250) (NVME)
Samsung	PCIe3 x4	960 EVO (MZ-V6E250BW) (NVME)
Samsung	PCIe3 x4	SM951 (NVME)
Samsung	PCIe3 x4	SM951 (MZHPV256HDGL)
Samsung	PCIe3 x4	SM951 (MZHPV512HDGL)
Samsung	PCIe3 x4	SM951 (NVME)
Samsung	PCIe x4	XP941-512G (MZHPU512HCGL)
SanDisk	PCIe	SD6PP4M-128G
SanDisk	PCIe	SD6PP4M-256G
TEAM	PCIe3 x4	TM8FP2240G0C101
TEAM	PCIe3 x4	TM8FP2480GC110
WD	PCIe3 x4	WDS256G1X0C-00ENX0 (NVME)
WD	PCIe3 x4	WDS512G1X0C-00ENX0 (NVME)

For the latest updates of M.2\_SSD (NFGG) module support list, please visit our website for details: <http://www.asrock.com>

## 2.12 M.2\_SSD (NGFF) Module Installation Guide (M2\_3)

The M.2, also known as the Next Generation Form Factor (NGFF), is a small size and versatile card edge connector that aims to replace mPCIe and mSATA. The Hyper M.2 Socket (M2\_3, Key M), supports type 2260/2280/22110 SATA3 6.0 Gb/s & PCIe Gen4x4 (64 Gb/s) modes.

### Installing the M.2\_SSD (NGFF) Module

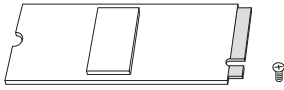

#### Step 1

Prepare a M.2\_SSD (NGFF) module and the screw.

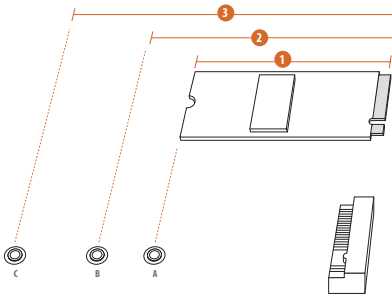

#### Step 2

Depending on the PCB type and length of your M.2\_SSD (NGFF) module, find the corresponding nut location to be used.

No.	1	2	3
Nut Location	A	B	C
PCB Length	6cm	8cm	11cm
Module Type	Type 2260	Type 2280	Type 22110

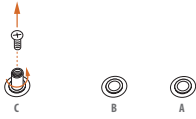
**Step 3**

Move the standoff based on the module type and length. The standoff is placed at the nut location C by default. Skip Step 3 and 4 and go straight to Step 5 if you are going to use the default nut. Otherwise, release the standoff by hand.

**Step 4**

Peel off the yellow protective film on the nut to be used. Hand tighten the standoff into the desired nut location on the motherboard.

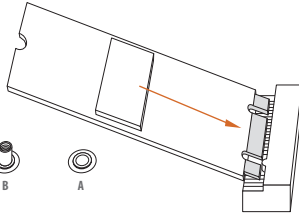
**Step 5**

Gently insert the M.2 (NGFF) SSD module into the M.2 slot. Please be aware that the M.2 (NGFF) SSD module only fits in one orientation.

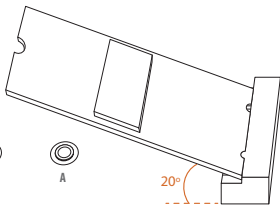
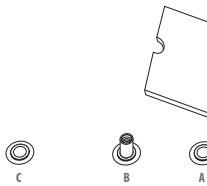
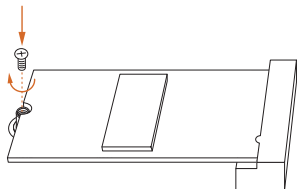
**Step 6**

Tighten the screw with a screwdriver to secure the module into place. Please do not overtighten the screw as this might damage the module.

## M.2\_SSD (NGFF) Module Support List (M2\_3)

Vendor	Interface	P/N
ADATA	SATA3	AXNS330E-32GM-B
ADATA	SATA3	AXNS381E-128GM-B
ADATA	SATA3	AXNS381E-256GM-B
ADATA	SATA3	ASU800NS38-256GT-C
ADATA	SATA3	ASU800NS38-512GT-C
ADATA	PCIe3 x4	ASX7000NP-128GT-C
ADATA	PCIe3 x4	ASX8000NP-256GM-C
ADATA	PCIe3 x4	ASX7000NP-256GT-C
ADATA	PCIe3 x4	ASX8000NP-512GM-C
ADATA	PCIe3 x4	ASX7000NP-512GT-C
Apacer	PCIe3 x4	AP240GZ280
Corsair	PCIe3 x4	CSSD-F240GBMP500
Crucial	SATA3	CT120M500SSD4
Crucial	SATA3	CT240M500SSD4
Intel	SATA3	Intel SSDSCCKGW080A401/80G
Intel	PCIe3 x4	SSDPEKKF256G7
Intel	PCIe3 x4	SSDPEKKF512G7
Kingston	SATA3	SM2280S3
Kingston	PCIe3 x4	SKC1000/480G
Kingston	PCIe2 x4	SH2280S3/480G
OCZ	PCIe3 x4	RVD400 -M2280-512G (NVME)
PATRIOT	PCIe3 x4	PH240GPM280SSDR NVME
Plextor	PCIe3 x4	PX-128M8PeG
Plextor	PCIe3 x4	PX-1TM8PeG
Plextor	PCIe3 x4	PX-256M8PeG
Plextor	PCIe3 x4	PX-512M8PeG
Plextor	PCIe	PX-G256M6e
Plextor	PCIe	PX-G512M6e
Samsung	PCIe3 x4	SM961 MZVPW128HEGM (NVM)
Samsung	PCIe3 x4	PM961 MZVLW128HEGR (NVME)
Samsung	PCIe3 x4	960 EVO (MZ-V6E250) (NVME)
Samsung	PCIe3 x4	960 EVO (MZ-V6E250BW) (NVME)
Samsung	PCIe3 x4	SM951 (NVME)
Samsung	PCIe3 x4	SM951 (MZHPV256HDGL)
Samsung	PCIe3 x4	SM951 (MZHPV512HDGL)
Samsung	PCIe3 x4	SM951 (NVME)
Samsung	PCIe x4	XP941-512G (MZHPU512HCGL)
SanDisk	PCIe	SD6PP4M-128G
SanDisk	PCIe	SD6PP4M-256G
Team	SATA3	TM4PS4128GMC105
Team	SATA3	TM4PS4256GMC105
Team	SATA3	TM8PS4128GMC105



Team	SATA3	TM8PS4256GMC105
TEAM	PCIe3 x4	TM8FP2240G0C101
TEAM	PCIe3 x4	TM8FP2480GC110
Transcend	SATA3	TS256GMTS400
Transcend	SATA3	TS512GMTS600
Transcend	SATA3	TS512GMTS800
V-Color	SATA3	VLM100-120G-2280B-RD
V-Color	SATA3	VLM100-240G-2280RGB
V-Color	SATA3	VSM100-240G-2280
V-Color	SATA3	VLM100-240G-2280B-RD
WD	SATA3	WDS100T1B0B-00AS40
WD	SATA3	WDS240G1G0B-00RC30
WD	PCIe3 x4	WDS256G1X0C-00ENX0 (NVME)
WD	PCIe3 x4	WDS512G1X0C-00ENX0 (NVME)

For the latest updates of M.2\_SSD (NFGG) module support list, please visit our website for details: <http://www.asrock.com>

## 2.12 M.2\_SSD (NGFF) Module Installation Guide (M2\_4)

The M.2, also known as the Next Generation Form Factor (NGFF), is a small size and versatile card edge connector that aims to replace mPCIe and mSATA. The Ultra M.2 Socket (M2\_4, Key M) supports type 2280 PCIe Gen3x4 (32 Gb/s) mode.

### Installing the M.2\_SSD (NGFF) Module

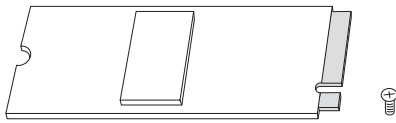

#### Step 1

Prepare a M.2\_SSD (NGFF) module and the screw.

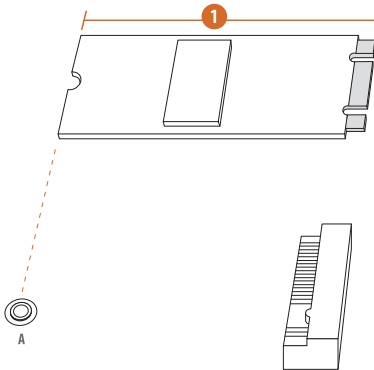

#### Step 2

Depending on the PCB type and length of your M.2\_SSD (NGFF) module, find the corresponding nut location to be used.

No.	1
Nut Location	A
PCB Length	8cm
Module Type	Type2280

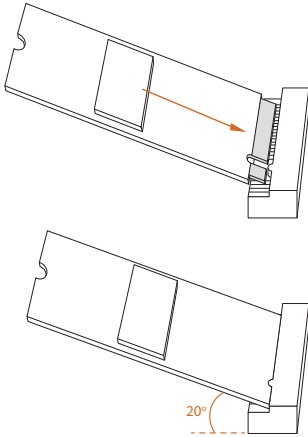
**Step 3**

Align and gently insert the M.2 (NGFF) SSD module into the M.2 slot. Please be aware that the M.2 (NGFF) SSD module only fits in one orientation.

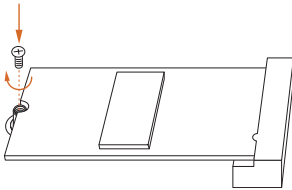
**Step 4**

Tighten the screw with a screwdriver to secure the module into place. Please do not overtighten the screw as this might damage the module.

## M.2\_SSD (NGFF) Module Support List (M2\_4)

Vendor	Interface	P/N
ADATA	PCIe3 x4	ASX7000NP-128GT-C
ADATA	PCIe3 x4	ASX8000NP-256GM-C
ADATA	PCIe3 x4	ASX7000NP-256GT-C
ADATA	PCIe3 x4	ASX8000NP-512GM-C
ADATA	PCIe3 x4	ASX7000NP-512GT-C
Apacer	PCIe3 x4	AP240GZ280
Corsair	PCIe3 x4	CSSD-F240GBMP500
Intel	PCIe3 x4	SSDPEKKF256G7
Intel	PCIe3 x4	SSDPEKKF512G7
Kingston	PCIe3 x4	SKC1000/480G
Kingston	PCIe2 x4	SH2280S3/480G
OCZ	PCIe3 x4	RVD400 -M2280-512G (NVME)
PATRIOT	PCIe3 x4	PH240GPM280SSDR NVME
Plextor	PCIe3 x4	PX-128M8PeG
Plextor	PCIe3 x4	PX-1TM8PeG
Plextor	PCIe3 x4	PX-256M8PeG
Plextor	PCIe3 x4	PX-512M8PeG
Plextor	PCIe	PX-G256M6e
Plextor	PCIe	PX-G512M6e
Samsung	PCIe3 x4	SM961 MZVPW128HEGM (NVM)
Samsung	PCIe3 x4	PM961 MZVLW128HEGR (NVME)
Samsung	PCIe3 x4	960 EVO (MZ-V6E250) (NVME)
Samsung	PCIe3 x4	960 EVO (MZ-V6E250BW) (NVME)
Samsung	PCIe3 x4	SM951 (NVME)
Samsung	PCIe3 x4	SM951 (MZHPV256HDGL)
Samsung	PCIe3 x4	SM951 (MZHPV512HDGL)
Samsung	PCIe3 x4	SM951 (NVME)
Samsung	PCIe x4	XP941-512G (MZHPU512HCGL)
SanDisk	PCIe	SD6PP4M-128G
SanDisk	PCIe	SD6PP4M-256G
TEAM	PCIe3 x4	TM8FP2240G0C101
TEAM	PCIe3 x4	TM8FP2480GC110
WD	PCIe3 x4	WDS256G1X0C-00ENX0 (NVME)
WD	PCIe3 x4	WDS512G1X0C-00ENX0 (NVME)

For the latest updates of M.2\_SSD (NFGG) module support list, please visit our website for details: <http://www.asrock.com>

## Chapter 3 Software and Utilities Operation

### 3.1 Installing Drivers

The Support CD that comes with the motherboard contains necessary drivers and useful utilities that enhance the motherboard's features.

#### Running The Support CD

To begin using the support CD, insert the CD into your CD-ROM drive. The CD automatically displays the Main Menu if "AUTORUN" is enabled in your computer. If the Main Menu does not appear automatically, locate and double click on the file "ASRSETUP.EXE" in the Support CD to display the menu.

#### Drivers Menu

The drivers compatible to your system will be auto-detected and listed on the support CD driver page. Please click **Install All** or follow the order from top to bottom to install those required drivers. Therefore, the drivers you install can work properly.

#### Utilities Menu

The Utilities Menu shows the application software that the motherboard supports. Click on a specific item then follow the installation wizard to install it.

## 3.2 ASRock Motherboard Utility (A-Tuning)

ASRock Motherboard Utility (A-Tuning) is ASRock's multi purpose software suite with a new interface, more new features and improved utilities.

### 3.2.1 Installing ASRock Motherboard Utility (A-Tuning)

ASRock Motherboard Utility (A-Tuning) can be downloaded from ASRock Live Update & APP Shop. After the installation, you will find the icon "ASRock Motherboard Utility (A-Tuning)" on your desktop. Double-click the "ASRock Motherboard Utility (A-Tuning)"  icon, ASRock Motherboard Utility (A-Tuning) main menu will pop up.

### 3.2.2 Using ASRock Motherboard Utility (A-Tuning)

There are five sections in ASRock Motherboard Utility (A-Tuning) main menu: Operation Mode, OC Tweaker, System Info, FAN-Tastic Tuning and Settings.

#### Operation Mode

Choose an operation mode for your computer.

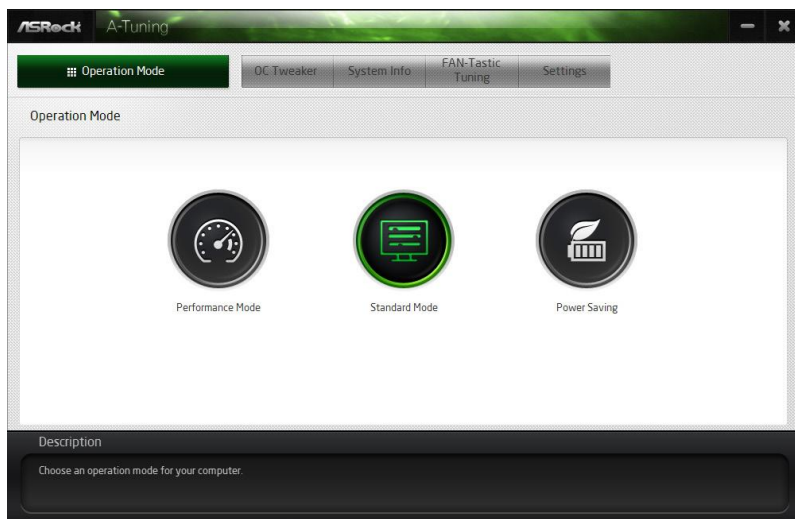

## OC Tweaker

Configurations for overclocking the system.

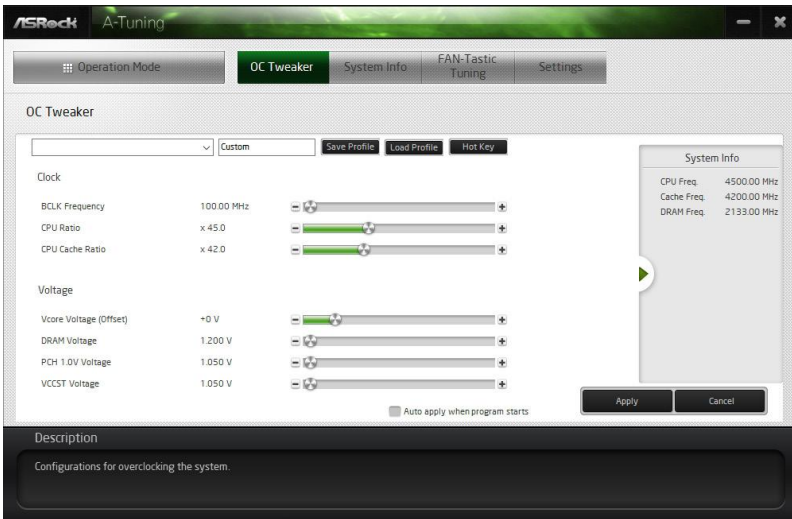

## System Info

View information about the system.

\*The System Browser tab may not appear for certain models.

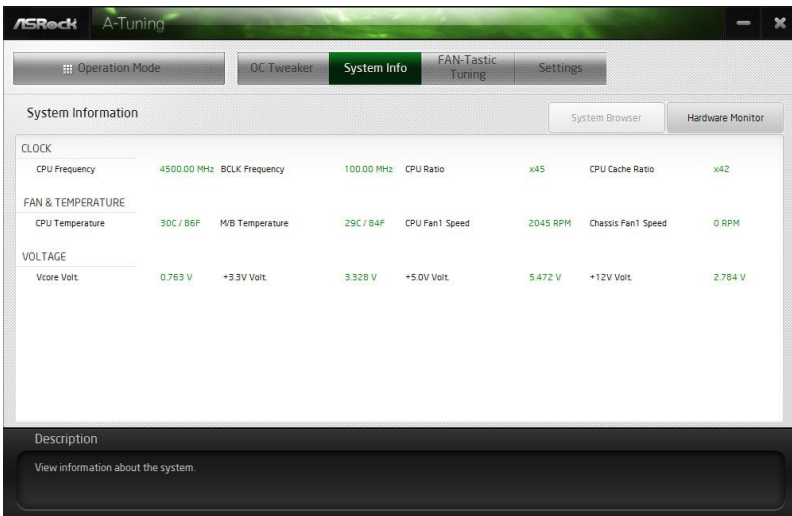

## FAN-Tastic Tuning

Configure up to five different fan speeds using the graph. The fans will automatically shift to the next speed level when the assigned temperature is met.

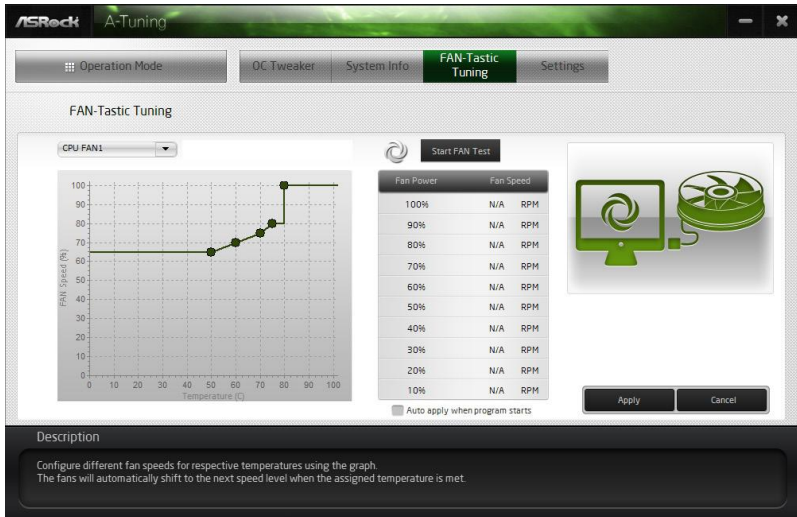

**FAN-Tastic Tuning**

CPU FAN1

Start FAN Test

Fan Power	Fan Speed
100%	N/A RPM
90%	N/A RPM
80%	N/A RPM
70%	N/A RPM
60%	N/A RPM
50%	N/A RPM
40%	N/A RPM
30%	N/A RPM
20%	N/A RPM
10%	N/A RPM

Auto apply when program starts

Apply Cancel

**Description**

Configure different fan speeds for respective temperatures using the graph. The fans will automatically shift to the next speed level when the assigned temperature is met.

## Settings

Configure ASRock ASRock Motherboard Utility (A-Tuning). Click to select "Auto run at Windows Startup" if you want ASRock Motherboard Utility (A-Tuning) to be launched when you start up the Windows operating system.

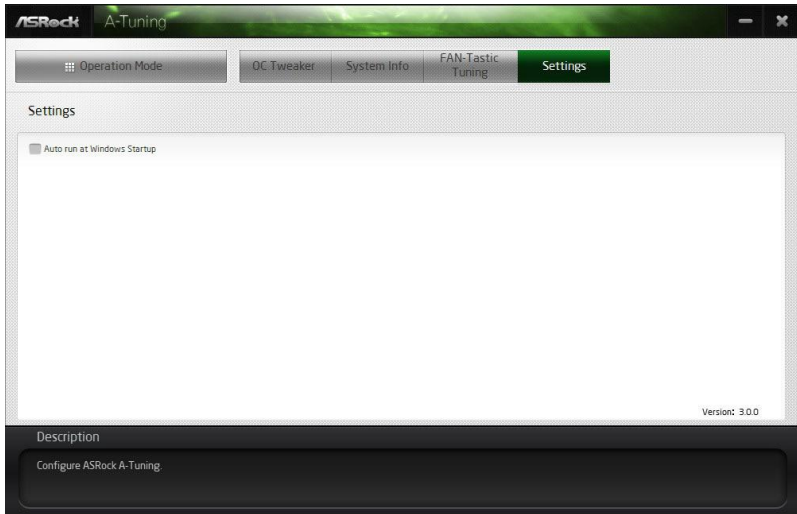

**ASRock A-Tuning Settings**

Auto run at Windows Startup

Version: 3.0.0

**Description**

Configure ASRock A-Tuning.



### 3.3 ASRock Live Update & APP Shop

The ASRock Live Update & APP Shop is an online store for purchasing and downloading software applications for your ASRock computer. You can quickly and easily install various apps and support utilities. With ASRock Live Update & APP Shop, you can optimize your system and keep your motherboard up to date simply with a few clicks.

Double-click  on your desktop to access ASRock Live Update & APP Shop utility.

*\*You need to be connected to the Internet to download apps from the ASRock Live Update & APP Shop.*

#### 3.3.1 UI Overview

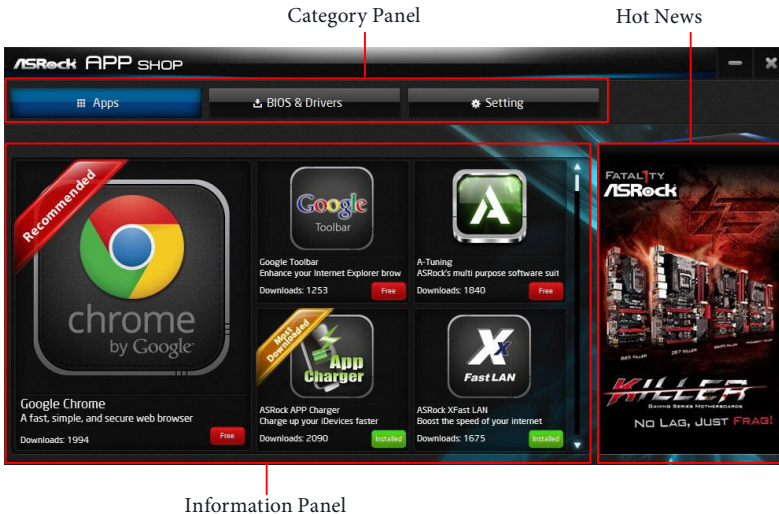

**Category Panel:** The category panel contains several category tabs or buttons that when selected the information panel below displays the relative information.

**Information Panel:** The information panel in the center displays data about the currently selected category and allows users to perform job-related tasks.

**Hot News:** The hot news section displays the various latest news. Click on the image to visit the website of the selected news and know more.

## 3.3.2 Apps

When the "Apps" tab is selected, you will see all the available apps on screen for you to download.

### Installing an App

#### Step 1

Find the app you want to install.



The most recommended app appears on the left side of the screen. The other various apps are shown on the right. Please scroll up and down to see more apps listed.

You can check the price of the app and whether you have already installed it or not.

 - The red icon displays the price or "Free" if the app is free of charge.

 - The green "Installed" icon means the app is installed on your computer.

#### Step 2

Click on the app icon to see more details about the selected app.

### Step 3

If you want to install the app, click on the red icon  to start downloading.



### Step 4

When installation completes, you can find the green "Installed" icon appears on the upper right corner.

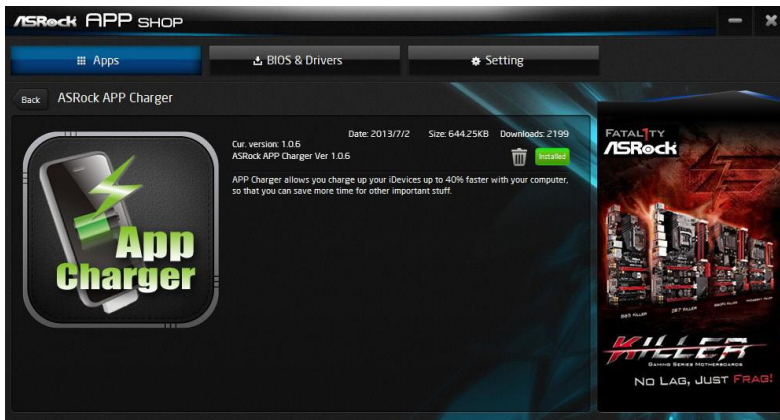

To uninstall it, simply click on the trash can icon .  
\*The trash icon may not appear for certain apps.

## Upgrading an App

You can only upgrade the apps you have already installed. When there is an available new version for your app, you will find the mark of "New Version"  appears below the installed app icon.



### Step 1

Click on the app icon to see more details.

### Step 2

Click on the yellow icon  to start upgrading.

### 3.3.3 BIOS & Drivers

#### Installing BIOS or Drivers

When the "BIOS & Drivers" tab is selected, you will see a list of recommended or critical updates for the BIOS or drivers. Please update them all soon.

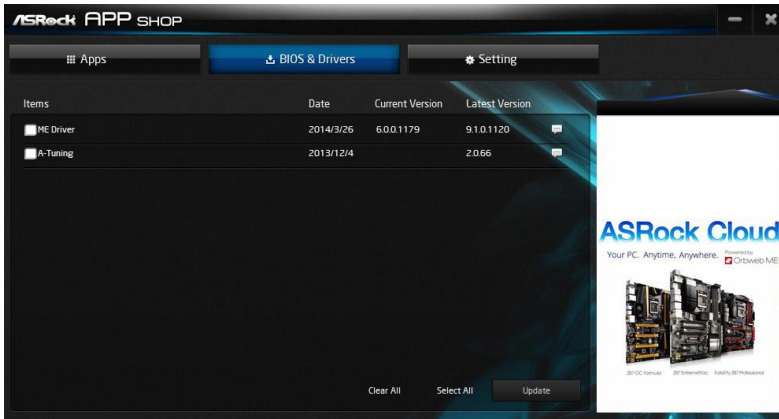

#### Step 1

Please check the item information before update. Click on  to see more details.

#### Step 2

Click to select one or more items you want to update.

#### Step 3

Click Update to start the update process.

### 3.3.4 Setting

In the "Setting" page, you can change the language, select the server location, and determine if you want to automatically run the ASRock Live Update & APP Shop on Windows startup.

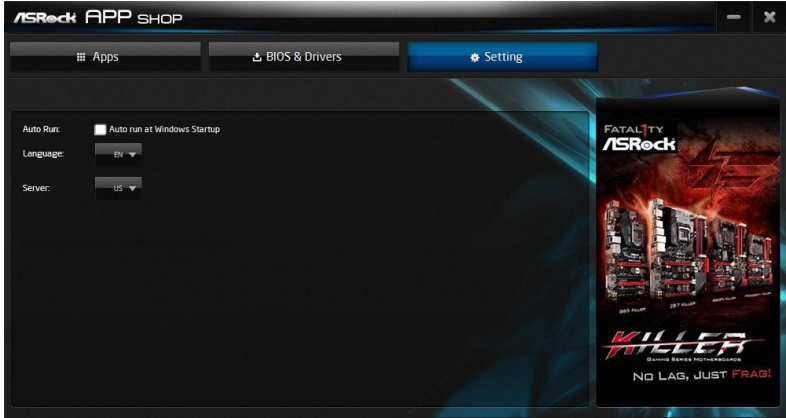

### 3.4 ASRock Polychrome SYNC

ASRock Polychrome SYNC is a lighting control utility specifically designed for unique individuals with sophisticated tastes to build their own stylish colorful lighting system. Simply by connecting the LED strip, you can customize various lighting schemes and patterns, including Static, Breathing, Strobe, Cycling, Music, Wave and more.

#### Connecting the LED Strip

Connect your RGB LED strip to the **RGB LED Header (RGB\_LED1)** on the motherboard.

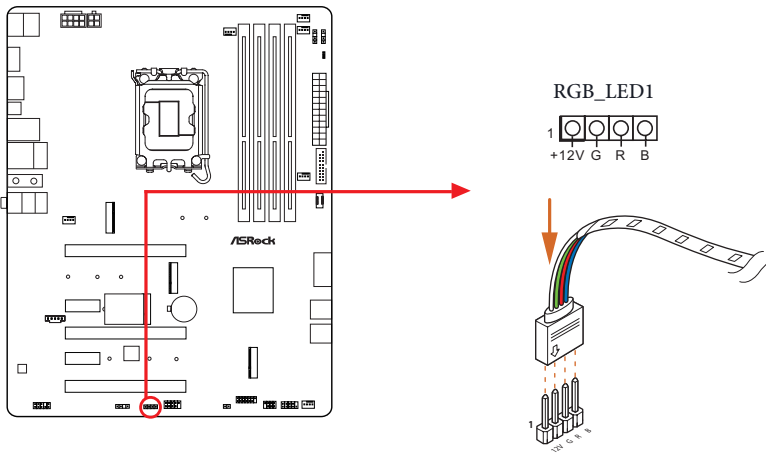

1. Never install the RGB LED cable in the wrong orientation; otherwise, the cable may be damaged.
2. Before installing or removing your RGB LED cable, please power off your system and unplug the power cord from the power supply. Failure to do so may cause damages to motherboard components.



1. Please note that the RGB LED strips do not come with the package.
2. The RGB LED header supports standard 5050 RGB LED strip (12V/G/R/B), with a maximum power rating of 3A (12V) and length within 2 meters.

## Connecting the Addressable RGB LED Strip

Connect your Addressable RGB LED strips to the **Addressable LED Headers (ADDR\_LED1 / ADDR\_LED2 / ADDR\_LED3)** on the motherboard.

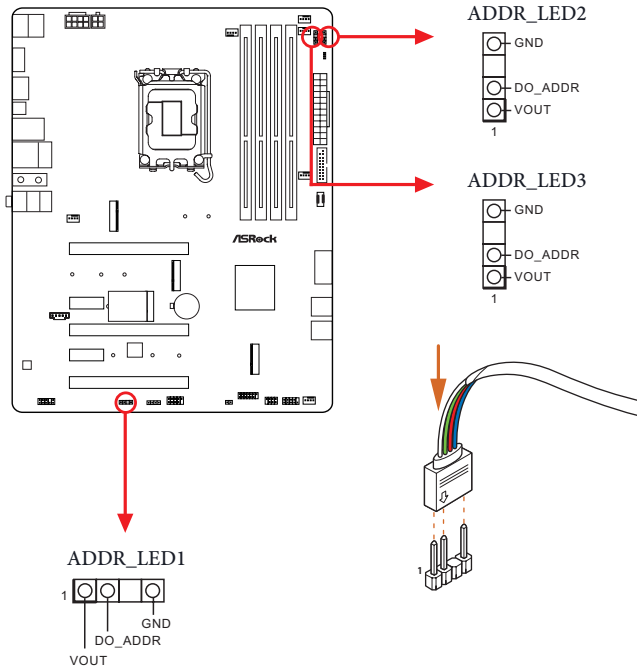

1. Never install the RGB LED cable in the wrong orientation; otherwise, the cable may be damaged.
2. Before installing or removing your RGB LED cable, please power off your system and unplug the power cord from the power supply. Failure to do so may cause damages to motherboard components.



1. Please note that the RGB LED strips do not come with the package.
2. The RGB LED header supports WS2812B addressable RGB LED strip (5V/Data/GND), with a maximum power rating of 3A (5V) and length within 2 meters.



## ASRock Polychrome SYNC Utility

Now you can adjust the RGB LED color through the ASRock Polychrome SYNC Utility. Download this utility from the ASRock Live Update & APP Shop and start coloring your PC style your way!

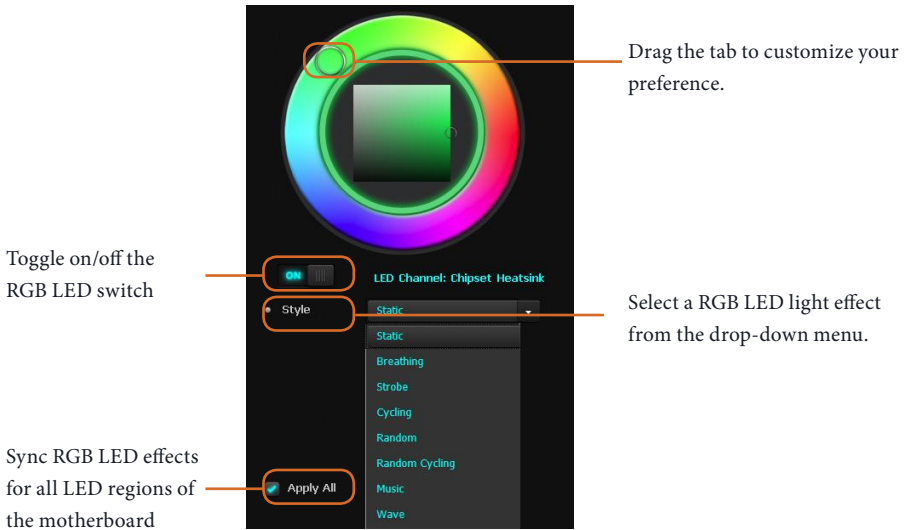

# Chapter 4 UEFI SETUP UTILITY

## 4.1 Introduction

This section explains how to use the UEFI SETUP UTILITY to configure your system. You may run the UEFI SETUP UTILITY by pressing <F2> or <Del> right after you power on the computer, otherwise, the Power-On-Self-Test (POST) will continue with its test routines. If you wish to enter the UEFI SETUP UTILITY after POST, restart the system by pressing <Ctl> + <Alt> + <Delete>, or by pressing the reset button on the system chassis. You may also restart by turning the system off and then back on.



*Because the UEFI software is constantly being updated, the following UEFI setup screens and descriptions are for reference purpose only, and they may not exactly match what you see on your screen.*

## 4.2 EZ Mode

The EZ Mode screen appears when you enter the BIOS setup program by default. EZ mode is a dashboard which contains multiple readings of the system's current status. You can check the most crucial information of your system, such as CPU speed, DRAM frequency, SATA information, fan speed, etc.

Press <F6> or click the "Advanced Mode" button at the upper right corner of the screen to switch to "Advanced Mode" for more options.

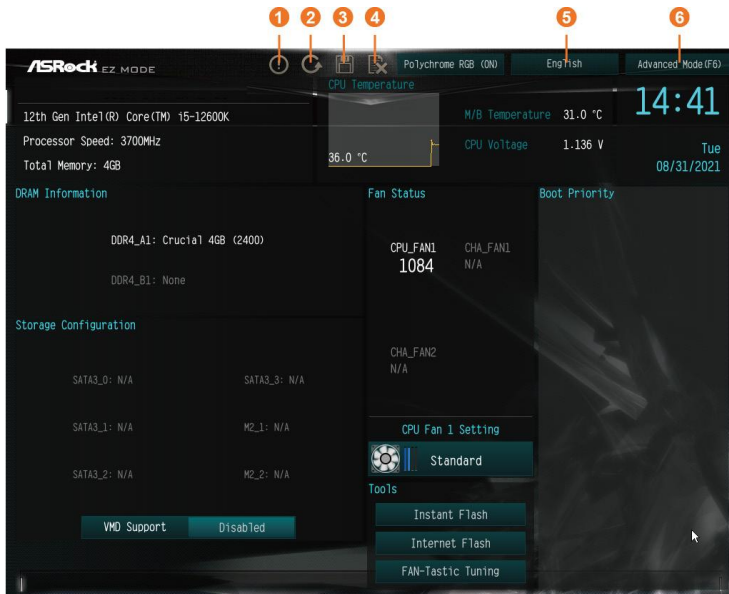

No.	Function
1	Help
2	Load UEFI Defaults
3	Save Changes and Exit
4	Discard Changes
5	Change Language
6	Switch to Advanced Mode

## 4.3 Advanced Mode

The Advanced Mode provides more options to configure the BIOS settings. Refer to the following sections for the detailed configurations.

To access the EZ Mode, press <F6> or click the "EZ Mode" button at the upper right corner of the screen.

### 4.3.1 UEFI Menu Bar

The top of the screen has a menu bar with the following selections:

<b>Main</b>	For setting system time/date information
<b>OC Tweaker</b>	For overclocking configurations
<b>Advanced</b>	For advanced system configurations
<b>Tool</b>	Useful tools
<b>H/W Monitor</b>	Displays current hardware status
<b>Security</b>	For security settings
<b>Boot</b>	For configuring boot settings and boot priority
<b>Exit</b>	Exit the current screen or the UEFI Setup Utility

### 4.3.2 Navigation Keys

Use <←> key or <→> key to choose among the selections on the menu bar, and use <↑> key or <↓> key to move the cursor up or down to select items, then press <Enter> to get into the sub screen. You can also use the mouse to click your required item.

Please check the following table for the descriptions of each navigation key.

Navigation Key(s)	Description
+ / -	To change option for the selected items
<Tab>	Switch to next function
<PGUP>	Go to the previous page
<PGDN>	Go to the next page
<HOME>	Go to the top of the screen
<END>	Go to the bottom of the screen
<F1>	To display the General Help Screen
<F5>	Add / Remove Favorite
<F7>	Discard changes and exit the SETUP UTILITY
<F9>	Load optimal default values for all the settings
<F10>	Save changes and exit the SETUP UTILITY
<F12>	Print screen
<ESC>	Jump to the Exit Screen or exit the current screen

## 4.4 Main Screen

When you enter the UEFI SETUP UTILITY, the Main screen will appear and display the system overview.



*The availability and location of BIOS settings can be different for different models and BIOS versions.*



### My Favorite

Display your collection of BIOS items. Press F5 to add/remove your favorite items.

## 4.5 OC Tweaker Screen

In the OC Tweaker screen, you can set up overclocking features.



*Because the UEFI software is constantly being updated, the following UEFI setup screens and descriptions are for reference purpose only, and they may not exactly match what you see on your screen.*

### CPU Configuration

#### CPU Turbo Ratio Information

This item allows users to browse the CPU Turbo Ratio information.

#### CPU Configuration

##### CPU P-Core Ratio

The CPU speed is determined by the CPU Ratio multiplied with the BCLK. Increasing the CPU Ratio will increase the internal CPU clock speed without affecting the clock speed of other components.

##### AVX2 Ratio Offset

AVX2 Ratio Offset specifies a negative offset from the CPU Ratio for AVX workloads. AVX is a more stressful workload that lower the AVX ratio to ensure maximum possible ratio for SSE workloads.

## Core Ratio Extension Mode

Enable or disable core ratio above 85 Extension mode.

[Enabled] Max overclocking ratio limit as specified by OCMB 0x1 command is 120

[Disabled] Max overclocking ratio limit as specified by OCMB 0x1 command is 85

## CPU E-Core Ratio

The E-Core speed is determined by the E-Core Ratio multiplied with the BCLK. Increasing the E-Core Ratio will increase the internal E-Core clock speed without affecting the clock speed of other components.

## Cluster 0 Max Ratio

Override ATOM Core 0 - 3 Maximum OC Ratio, maximum value up to 120.

## Cluster 1 Max Ratio

Override ATOM Core 4 - 7 Maximum OC Ratio, maximum value up to 120.

## CPU Cache Ratio

The CPU Internal Bus Speed Ratio. The maximum should be the same as the CPU Ratio.

## BCLK Frequency

The CPU speed is determined by the CPU Ratio multiplied with the BCLK. Increasing the BCLK will increase the internal CPU clock speed but also affect the clock speed of other components.

## BCLK Aware Adaptive Voltage

BCLK Aware Adaptive Voltage enable/disable. When enabled, pcode will be aware of the BCLK frequency when calculating the CPU V/F curves. This is ideal for BCLK OC to avoid high voltage overrides.

## Boot Performance Mode

Select the performance state that the BIOS will set before OS handoff.

## Ring to Core Ratio Offset

Disable Ring to Core Ratio Offset so the ring and core can run at the same frequency.

## Intel SpeedStep Technology

Intel SpeedStep technology allows processors to switch between multiple frequencies and voltage points for better power saving and heat dissipation.



## Intel Turbo Boost Technology

Intel Turbo Boost Technology enables the processor to run above its base operating frequency when the operating system requests the highest performance state.

## Intel Speed Shift Technology

Enable/Disable Intel Speed Shift Technology support. Enabling will expose the CPPC v2 interface to allow for hardware controlled P-states.

## Intel Turbo Boost Max Technology 3.0

Intel Turbo Boost Technology enables the processor to run above its base operating frequency when the operating system requests the highest performance state.

## Intel Thermal Velocity Boost Voltage Optimizations

This service controls thermal based voltage optimizations for processors that implement the Intel Thermal Velocity Boost (TVB) feature.

## CPU Tj Max

Set CPU Tj Max to adjust TCC Target Temperature. Default setting is 105°C.

## Dual Tau Boost

Enable Dual Tau Boost feature. This is only applicable for CMLS 35W/65W/125W skus. This item is only supported with processors with Config TDP support.

## Long Duration Power Limit

Configure Package Power Limit 1 in watts. When the limit is exceeded, the CPU ratio will be lowered after a period of time. A lower limit can protect the CPU and save power, while a higher limit may improve performance.

## Long Duration Maintained

Configure the period of time until the CPU ratio is lowered when the Long Duration Power Limit is exceeded.

## Short Duration Power Limit

Configure Package Power Limit 2 in watts. When the limit is exceeded, the CPU ratio will be lowered immediately. A lower limit can protect the CPU and save power, while a higher limit may improve performance.

## CPU Core Unlimited Current Limit

To unlock voltage regulator current limit completely, you can set this option to Enabled.

## CPU Core Current Limit

Configure the current limit of the CPU core. A lower limit can protect the CPU and save power, while a higher limit may improve performance.

## GT Unlimited Current Limit

To unlock voltage regulator current limit completely, you can set this option to Enabled.

## GT Current Limit

Configure the current limit of the GT slice. A lower limit can protect the CPU and save power, while a higher limit may improve performance.

## DRAM Configuration

### Memory Information

Allows users to browse the serial presence detect (SPD) and Intel extreme memory profile (XMP) for DDR4 modules.

### DRAM Timing Configuration

#### Load XMP Setting

Load XMP settings to overclock the memory and perform beyond standard specifications.

#### DRAM Reference Clock

Select Auto for optimized settings.

#### DRAM Frequency

If [Auto] is selected, the motherboard will detect the memory module(s) inserted and assign the appropriate frequency automatically.

#### DRAM Gear Mode

High gear is good for high frequency.

#### BCLK Frequency

Configure the BCLK Frequency.

#### Primary Timing

##### CAS# Latency (tCL)

The time between sending a column address to the memory and the beginning of the data in response.

### RAS# to CAS# Delay and Row Precharge (tRCDtRP)

RAS# to CAS# Delay : The number of clock cycles required between the opening of a row of memory and accessing columns within it.

Row Precharge: The number of clock cycles required between the issuing of the precharge command and opening the next row.

### RAS# Active Time (tRAS)

The number of clock cycles required between a bank active command and issuing the precharge command.

### Command Rate (CR)

The delay between when a memory chip is selected and when the first active command can be issued.

### Secondary Timing

#### Write Recovery Time (tWR)

The amount of delay that must elapse after the completion of a valid write operation, before an active bank can be precharged.

#### Refresh Cycle Time (tRFC)

The number of clocks from a Refresh command until the first Activate command to the same rank.

#### RAS to RAS Delay (tRRD\_L)

The number of clocks between two rows activated in different banks of the same rank.

#### RAS to RAS Delay (tRRD\_S)

The number of clocks between two rows activated in different banks of the same rank.

#### Read to Precharge (tRTP)

The number of clocks that are inserted between a read command to a row precharge command to the same rank.

#### Four Activate Window (tFAW)

The time window in which four activates are allowed the same rank.

#### CAS Write Latency (tCWL)

Configure CAS Write Latency.

## Third Timing

### tREFI

Configure refresh cycles at an average periodic interval.

### tCKE

Configure the period of time the DDR4 initiates a minimum of one refresh command internally once it enters Self-Refresh mode.

## Turn Around Timing

### Turn Around Timing Optimization

Auto is enabled in general case.

## TAT Training Value

### tRDRD\_sg

Configure between module read to read delay.

### tRDRD\_dg

Configure between module read to read delay.

### tRDRD\_dr

Configure between module read to read delay.

### tRDRD\_dd

Configure between module read to read delay.

### tRDWR\_sg

Configure between module read to write delay.

### tRDWR\_dg

Configure between module read to write delay.

### tRDWR\_dr

Configure between module read to write delay.

### tRDWR\_dd

Configure between module read to write delay.

### tWRRD\_sg

Configure between module write to read delay.

**tWRRD\_dg**

Configure between module write to read delay.

**tWRRD\_dr**

Configure between module write to read delay.

**tWRRD\_dd**

Configure between module write to read delay.

**tWRWR\_sg**

Configure between module write to write delay.

**tWRWR\_dg**

Configure between module write to write delay.

**tWRWR\_dr**

Configure between module write to write delay.

**tWRWR\_dd**

Configure between module write to write delay.

**TAT Runtime Value****tRDRD\_sg**

Configure between module read to read delay.

**tRDRD\_dg**

Configure between module read to read delay.

**tRDRD\_dr**

Configure between module read to read delay.

**tRDRD\_dd**

Configure between module read to read delay.

**tRDWR\_sg**

Configure between module read to write delay.

**tRDWR\_dg**

Configure between module read to write delay.

**tRDWR\_dr**

Configure between module read to write delay.

**tRDWR\_dd**

Configure between module read to write delay.

**tWRRD\_sg**

Configure between module write to read delay.

**tWRRD\_dg**

Configure between module write to read delay.

**tWRRD\_dr**

Configure between module write to read delay.

**tWRRD\_dd**

Configure between module write to read delay.

**tWRWR\_sg**

Configure between module write to write delay.

**tWRWR\_dg**

Configure between module write to write delay.

**tWRWR\_dr**

Configure between module write to write delay.

**tWRWR\_dd**

Configure between module write to write delay.

**Round Trip Timing**

**Round Trip Timing Optimization**

Auto is enabled in general case.

**Round Trip Level**

Configure round trip level.

**Initial RTL IO Delay Offset**

Configure round trip latency IO delay initial offset.

### Initial RTL FIFO Delay Offset

Configure round trip latency FIFO delay initial offset.

### Initial RTL (MC0 C0 A1/A2)

Configure round trip latency initial value.

### Initial RTL (MC0 C1 A1/A2)

Configure round trip latency initial value.

### Initial RTL (MC1 C0 B1/B2)

Configure round trip latency initial value.

### Initial RTL (MC1 C1 B1/B2)

Configure round trip latency initial value.

### RTL (MC0 C0 A1/A2)

Configure round trip latency.

### RTL (MC0 C1 A1/A2)

Configure round trip latency.

### RTL (MC1 C0 B1/B2)

Configure round trip latency.

### RTL (MC1 C1 B1/B2)

Configure round trip latency.

## ODT Setting

### Dimm ODT Training

ODT values will be optimized by Dimm On-Die Termination Training.

### ODT WR (A1)

Configure the memory on die termination resistors' WR for channel A1.

### ODT WR (A2)

Configure the memory on die termination resistors' WR for channel A2.

### ODT WR (B1)

Configure the memory on die termination resistors' WR for channel B1.

### ODT WR (B2)

Configure the memory on die termination resistors' WR for channel B2.

### ODT NOM (A1)

Use this to change ODT (CH A1) Auto/Manual settings. The default is [Auto].

### ODT NOM (A2)

Use this to change ODT (CH A2) Auto/Manual settings. The default is [Auto].

### ODT NOM (B1)

Use this to change ODT (CH B1) Auto/Manual settings. The default is [Auto].

### ODT NOM (B2)

Use this to change ODT (CH B2) Auto/Manual settings. The default is [Auto].

### ODT PARK (A1)

Configure the memory on die termination resistors' PARK for channel A1.

### ODT PARK (A2)

Configure the memory on die termination resistors' PARK for channel A2.

### ODT PARK (B1)

Configure the memory on die termination resistors' PARK for channel B1.

### ODT PARK (B2)

Configure the memory on die termination resistors' PARK for channel B2.

## Advanced Setting

### ASRock Timing Optimization

Configure the fast path through the MRC.

### ASRock Second Timing Optimization

Configure the second fast path through the MRC.

### Realtime Memory Timing

Configure the realtime memory timings.

[Enabled] The system will allow performing realtime memory timing changes after MRC\_DONE.



## Early Command Training

Configure the Early Command Training.

Early Command Training is the initial step after reading SPD and configuring DDR interface to desired speed/timings.

## Read Equalization Training

Configure the Read Equalization Training.

## Reset for MRC Failed

Reset system after MRC training is failed.

## MRC Training on Warm Boot

When enabled, memory training will be executed when warm boot.

## MRC Fast Boot

Enable Memory Fast Boot to skip DRAM memory training for booting faster.

## Voltage Configuration

### Voltage Mode

[OC]: Larger range voltage for overclocking.

[STABLE]: Smaller range voltage for stable system.

### CPU Core/Cache Voltage

Input voltage for the processor by the external voltage regulator.

### CPU Core/Cache Load-Line Calibration

CPU Core/Cache Load-Line Calibration helps prevent CPU Core/Cache voltage droop when the system is under heavy loading.

### CPU GT Voltage

Configure the voltage for the integrated GPU.

### CPU GT Load-Line Calibration

GT Load-Line Calibration helps prevent integrated GPU voltage droop when the system is under heavy load.

### DRAM Voltage

Use this to configure DRAM Voltage. The default value is [Auto].

## VDD\_IMC Voltage

VDD\_IMC Voltage for memory controller.

## DRAM Activating Power Supply

Configure the voltage for the DRAM Activating Power Supply.

## VCCIN AUX Voltage

Configure the voltage for the VCCIN AUX.

## +1.8V PROC Voltage

Configure the voltage for the +1.8V PROC.

## +1.05V PROC Voltage

Configure the voltage for the +1.05V PROC.

## +0.82V PCH Voltage

Configure the voltage for the +0.82V PCH.

## +1.05 PCH Voltage

Configure the voltage for the +1.05 PCH.

## PLL Voltage Configuration

### P-Core PLL Voltage Offset

Use this feature to set the PLL Voltage Offset value from 0-15 with each unit at 17.5mV. This is used to increase the range of the domain frequency in extreme overclocking conditions. Enter 0 to use the manufacturer default value.

### GT PLL Voltage Offset

Use this feature to set the PLL Voltage Offset value from 0-15 with each unit at 17.5mV. This is used to increase the range of the domain frequency in extreme overclocking conditions. Enter 0 to use the manufacturer default value.

### Ring PLL Voltage Offset

Use this feature to set the PLL Voltage Offset value from 0-15 with each unit at 17.5mV. This is used to increase the range of the domain frequency in extreme overclocking conditions. Enter 0 to use the manufacturer default value.

### System Agent PLL Voltage Offset

Use this feature to set the PLL Voltage Offset value from 0-15 with each unit at

17.5mV. This is used to increase the range of the domain frequency in extreme overclocking conditions. Enter 0 to use the manufacturer default value.

### E-Core PLL Voltage Offset

Use this feature to set the PLL Voltage Offset value from 0-15 with each unit at 17.5mV. This is used to increase the range of the domain frequency in extreme overclocking conditions. Enter 0 to use the manufacturer default value.

### Memory Controller PLL Voltage Offset

Use this feature to set the PLL Voltage Offset value from 0-15 with each unit at 17.5mV. This is used to increase the range of the domain frequency in extreme overclocking conditions. Enter 0 to use the manufacturer default value.

## AVX Configuration

### AVX2 Voltage Guardband Scale Factor

AVX2 Voltage Guardband Scale Factor controls the voltage guardband applied to AVX2 workloads. A value > 1.00 will increase the voltage guardband, and < 1.00 will decrease the voltage guardband.

## FIVR Configuration

### Core Voltage Mode

Selects between Adaptive and Override Voltage modes. In Override Mode, the voltage selected will be applied over all operating frequencies. In Adaptive mode, the voltage is interpolated only in turbo mode.

### Core Extra Turbo Voltage

Specifies the extra turbo voltage applied while the IA Core is operating in turbo mode.

### VF Offset Mode

Selects between Legacy and Selection modes. Need Reset System after enabling OverClocking Feature to initialize the default value. In Legacy Mode, setting a global offset for the entire VF curve. In Selection modes, setting a selected VF point.

### VF Configuration Scope

Allows all cores VF curve or per-core VF curve configuration.

### Core Voltage Offset

Specifies the offset voltage applied to the IA Core domain. This voltage is specified in millivolts.

## Offset Prefix

Sets the offset value as positive or negative.

## E-Core L2 Voltage Mode

Selects between adaptive and Override Voltage modes. In Override Mode the voltage selected will be applied over all operating frequencies. In Adaptive Mode the voltage is interpolated only in turbo mode. Uses Mailbox 0SR 0x150, cmd 0x10, 0x11.

## E-Core L2 Extra Turbo Voltage

Specifies the extra turbo voltage applied while Atom L2 is operating in turbo mode. Uses Mailbox MSR 0x150, cmd 0x10, 0x11. Range 0-2000 mV.

## E-Core L2 Voltage Offset

Specifies the Offset Voltage applied to the Atom L2 domain. This voltage is specified in millivolts. Uses Mailbox MSR 0x150, cmd 0x11. Range -500 to 500 mV.

## Offset Prefix

Sets the offset value as positive or negative.

## Ring Voltage Mode

Selects between adaptive and Override Voltage modes. In Override Mode the voltage selected will be applied over all operating frequencies. In Adaptive Mode the voltage is interpolated only in turbo mode. Uses Mailbox 0SR 0x150, cmd 0x10, 0x11.

## Ring Extra Turbo Voltage

Specifies the extra turbo voltage applied while ring is operating in turbo mode. Uses Mailbox MSR 0x150, cmd 0x10, 0x11. Range 0-2000 mV.

## VF Offset Mode

Selects between Legacy and Selection modes. Need Reset System after enabling OverClocking Feature to initialize the default value. In Legacy Mode, setting a global offset for the entire VF curve. In Selection modes, setting a selected VF point.

## Ring Voltage Offset

Specifies the Offset Voltage applied to the Ring domain. This voltage is specified in millivolts. Uses Mailbox MSR 0x150, cmd 0x11. Range -500 to 500 mV.

### Offset Prefix

Sets the offset value as positive or negative.

### GT Voltage Mode

Selects between adaptive and Override Voltage modes. In Override Mode the voltage selected will be applied over all operating frequencies. In Adaptive Mode the voltage is interpolated only in turbo mode. Uses Mailbox 0SR 0x150, cmd 0x10, 0x11.

### GT Extra Turbo Voltage

Specifies the extra turbo voltage applied while GT is operating in turbo mode. Uses Mailbox MSR 0x150, cmd 0x10, 0x11. Range 0-2000 mV.

### GT Voltage Offset

Specifies the Offset Voltage applied to the GT domain. This voltage is specified in millivolts. Uses Mailbox MSR 0x150, cmd 0x11. Range -500 to 500 mV.

### Offset Prefix

Sets the offset value as positive or negative.

### Uncore Voltage Mode

Selects between adaptive and Override Voltage modes. In Override Mode the voltage selected will be applied over all operating frequencies. In Adaptive Mode the voltage is interpolated only in turbo mode. Uses Mailbox 0SR 0x150, cmd 0x10, 0x11.

### Uncore Extra Turbo Voltage

Specifies the extra turbo voltage applied while SA Uncore is operating in turbo mode. Uses Mailbox MSR 0x150, cmd 0x10, 0x11. Range 0-2000 mV.

### Uncore Voltage Offset

Specifies the Offset Voltage applied to the Uncore domain. This voltage is specified in millivolts. Uses Mailbox MSR 0x150, cmd 0x11. Range -500 to 500 mV.

### Offset Prefix

Sets the offset value as positive or negative.

### Save User Default

Type a profile name and press enter to save your settings as user default.

---

### Load User Default

Load previously saved user defaults.

### Save User UEFI Setup Profile to Disk

It helps you to save current UEFI settings as an user profile to disk.

### Load User UEFI Setup Profile from Disk

You can load previous saved profile from the disk.

## 4.6 Advanced Screen

In this section, you may set the configurations for the following items: CPU Configuration, Chipset Configuration, Storage Configuration, Intel(R) Thunderbolt, Super IO Configuration, ACPI Configuration, USB Configuration and Trusted Computing.



*Setting wrong values in this section may cause the system to malfunction.*

### UEFI Configuration

#### UEFI Setup Style

Select the default mode when entering the UEFI setup utility.

#### Active Page on Entry

Select the default page when entering the UEFI setup utility.

#### Full HD UEFI

When [Auto] is selected, the resolution will be set to 1920 x 1080 if the monitor supports Full HD resolution. If the monitor does not support Full HD resolution, then the resolution will be set to 1024 x 768. When [Disable] is selected, the resolution will be set to 1024 x 768 directly.

## 4.6.1 CPU Configuration



### Processor E-Core Information

This item displays the E-Core Information.

### Processor P-Core Information

This item displays the P-Core Information.

### Intel Hyper Threading Technology

Intel Hyper Threading Technology allows multiple threads to run on each core, so that the overall performance on threaded software is improved.

### Pre-Core Hyper Threading

The Pre-Core Hyper Threading feature allows you to disable Hyper Threading on specific cores.

### Active Processor E-Cores

Select the number of E-cores to enable in each processor package.

### Active Processor P-Cores

Select the number of P-cores to enable in each processor package.

### CPU C States Support

Enable CPU C States Support for power saving. It is recommended to keep C6 and C7 enabled for better power saving.



### Enhanced Halt State (C1E)

Enable Enhanced Halt State (C1E) for lower power consumption.

### CPU C6 State Support

Enable C6 deep sleep state for lower power consumption.

### CPU C7 State Support

Enable C7 deep sleep state for lower power consumption.

### Package C State Support

Enable CPU, PCIe, Memory, Graphics C State Support for power saving.

### CFG Lock

This item allows you to disable or enable the CFG Lock.

### C6DRAM

Enable/Disable moving of DRAM contents to PRM memory when CPU is in C6 state.

### CPU Thermal Throttling

Enable CPU internal thermal control mechanisms to keep the CPU from overheating.

### Intel AVX/AVX2

Enable/Disable the Intel AVX and AVX2 Instructions. This is applicable for Big Core only.

### Intel Virtualization Technology

Intel Virtualization Technology allows a platform to run multiple operating systems and applications in independent partitions, so that one computer system can function as multiple virtual systems.

### Hardware Prefetcher

Automatically prefetch data and code for the processor. Enable for better performance.

### Adjacent Cache Line Prefetch

Automatically prefetch the subsequent cache line while retrieving the currently requested cache line. Enable for better performance.

---

## Legacy Game Compatibility Mode

When enabled, pressing the scroll lock key will toggle the Efficient cores between being parked when Scroll Lock LED is on and un-parked when LED is off.

## 4.6.2 Chipset Configuration



### Primary Graphics Adapter

Select a primary VGA.

### Above 4G Decoding

Enable or disable 64bit capable Devices to be decoded in Above 4G Address Space (only if the system supports 64 bit PCI decoding).

### C.A.M (Clever Access Memory)

If system has Resizable BAR capable PCIe Devices, use this option to enable or disable Resizable BAR support (only of the system supports 64-bit PCI decoding).

### VT-d

Intel® Virtualization Technology for Directed I/O helps your virtual machine monitor better utilize hardware by improving application compatibility and reliability, and providing additional levels of manageability, security, isolation, and I/O performance.

### SR-IOV Support

If system has SR-IOV capable PCIe Devices, this option Enables or Disables Single Root IO Virtualization Support.

### DMI Link Speed

Configure DMI Slot Link Speed. Auto mode is optimizing for overclocking.

### PCIE1 Link Speed

Select the link speed for PCIE1.

### PCIE2 Link Speed

Select the link speed for PCIE2.

### PCIE3 Link Speed

Select the link speed for PCIE3.

### PCIE4 Link Speed

Select the link speed for PCIE4.

### PCIE5 Link Speed

Select the link speed for PCIE5.

### PCI Express Native Control

Select Enable for enhanced PCI Express power saving in OS.

### PCIE ASPM Support

This option enables/disables the ASPM support for all CPU downstream devices.

### PCH PCIE ASPM Support

This option enables/disables the ASPM support for all PCH PCIE devices.

### DMI ASPM Support

This option enables/disables the control of ASPM on CPU side of the DMI Link.

### PCH DMI ASPM Support

This option enables/disables the ASPM support for all PCH DMI devices.

### Share Memory

Configure the size of memory that is allocated to the integrated graphics processor when the system boots up.

### IGPU Multi-Monitor

Select disable to disable the integrated graphics when an external graphics card is installed. Select enable to keep the integrated graphics enabled at all times.

### Inte(R) Ethernet Connection I219-V

Enable or disable the onboard network interface controller (Intel® I219V).

## Onboard HD Audio

Enable/disable onboard HD audio. Set to Auto to enable onboard HD audio and automatically disable it when a sound card is installed.

## Front Panel

Enable/disable front panel HD audio.

## Onboard HDMI HD Audio

Enable audio for the onboard digital outputs.

## Onboard WAN Device

Use this item to enable or disable the onboard WAN device.

## Deep Sleep

Configure deep sleep mode for power saving when the computer is shut down.

## Restore on AC/Power Loss

Select the power state after a power failure. If [Power Off] is selected, the power will remain off when the power recovers. If [Power On] is selected, the system will start to boot up when the power recovers.

## Turn On Onboard LED in S5

Turn on Onboard LED in the ACPI S5 state.

## Restore Onboard LED Default

Restore Onboard LED default value.

## RGB LED

This option enables/disables the RGB LED.

## 4.6.3 Storage Configuration



### SATA Controller(s)

Enable/disable the SATA controllers.

### SATA Mode Selection

AHCI: Supports new features that improve performance.

### Hybrid Storage Detection and Configuration Mode

This item allows you select Hybrid Storage Detection and Configuration Mode.

### SATA Aggressive Link Power Management

SATA Aggressive Link Power Management allows SATA devices to enter a low power state during periods of inactivity to save power. It is only supported by AHCI mode.

### Hard Disk S.M.A.R.T.

S.M.A.R.T stands for Self-Monitoring, Analysis, and Reporting Technology. It is a monitoring system for computer hard disk drives to detect and report on various indicators of reliability.

## VMD Configuration

This item allows you to enable or disable the Intel VMD support function.

## 4.6.4 Intel(R) Thunderbolt

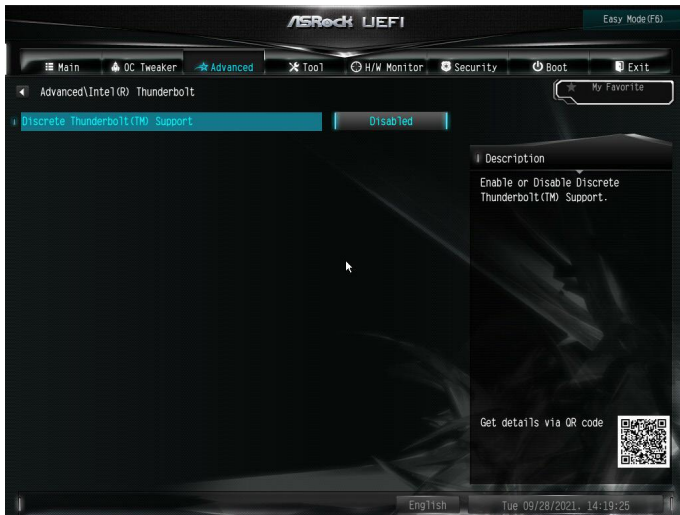

### Discrete Thunderbolt(TM) Support

Enable or disable the Discrete Thunderbolt(TM) Support.

### Thunderbolt Boot Support

Enabled to allow booting from Bootable devices which are present behind Thunderbolt.

### Thunderbolt Usb Support

Enabled to allow booting from Usb devices which are present behind Thunderbolt.

### Windows 10 Thunderbolt support

Enable or disable the Windows 10 Thunderbolt support.



## 4.6.5 Super IO Configuration



### PS2 Y-Cable

Enable the PS2 Y-Cable or set this option to Auto.

## 4.6.6 ACPI Configuration



### Suspend to RAM

Select disable for ACPI suspend type S1. It is recommended to select auto for ACPI S3 power saving.

### PS/2 Keyboard S4/S5 Wakeup Support

Allow the system to be waked up by a PS/2 Keyboard in S4/S5.

### PCIE Devices Power On

Allow the system to be waked up by a PCIE device and enable wake on LAN.

### I219 LAN Power On

Allow the system to be waked up by the Onboard Intel LAN.

### RTC Alarm Power On

Allow the system to be waked up by the real time clock alarm. Set it to By OS to let it be handled by your operating system.

### USB Keyboard/Remote Power On

Allow the system to be waked up by an USB keyboard or remote controller.

### USB Mouse Power On

Allow the system to be waked up by an USB mouse.

## 4.6.7 USB Configuration



### Legacy USB Support

Enable or disable Legacy OS Support for USB 2.0 devices. If you encounter USB compatibility issues it is recommended to disable legacy USB support. Select UEFI Setup Only to support USB devices under the UEFI setup and Windows/Linux operating systems only.

### XHCI Hand-off

This is a workaround for OSes without XHCI hand-off support. The XHCI ownership change should be claimed by XHCI driver.

## 4.6.8 Trusted Computing



NOTE: Options vary depending on the version of your connected TPM module.

### Security Device Support

Use this item to enable or disable BIOS support for security device. O.S. will not show Security Device. TCG EFI protocol and INT1A interface will not be available.

### Active PCR banks

This item displays active PCR Banks.

### Available PCR Banks

This item displays available PCR Banks.

### SHA256 PCR Bank

Use this item to enable or disable SHA256 PCR Bank.

### SHA384 PCR Bank

Use this item to enable or disable SHA384 PCR Bank.

### SM3\_256 PCR Bank

Use this item to enable or disable SM3\_256 PCR Bank.

### Pending Operation

Schedule an Operation for the Security Device.

NOTE: Your computer will reboot during restart in order to change State of the Device.

## Platform Hierarchy

Use this item to enable or disable Platform Hierarchy.

## Storage Hierarchy

Use this item to enable or disable Storage Hierarchy.

## Endorsement Hierarchy

Use this item to enable or disable Endorsement Hierarchy.

## Physical Presence Spec version

Select this item to tell OS to support PPI spec version 1.2 or 1.3. Please note that some HCK tests might not support version 1.3.

## Device Select

Use this item to select the TPM device to be supported. TPM 1.2 will restrict support to TPM 1.2 devices. TPM 2.0 will restrict support to TPM 2.0 devices. Auto will support both with the default set to TPM 2.0 devices. If TPM 2.0 devices are not found, TPM 1.2 devices will be enumerated.

## 4.7 Tools



### ASRock Polychrome RGB

Select LED lighting color.

### UEFI Tech Service

Contact ASRock Tech Service if you are having trouble with your PC. Please setup network configuration before using UEFI Tech Service.

### Easy RAID Installer

Easy RAID Installer helps you to copy the RAID driver from the support CD to your USB storage device. After copying the drivers please change the SATA mode to RAID, then you can start installing the operating system in RAID mode.

### SSD Secure Erase Tool

All the SSD's listed that supports Secure Erase function.

### NVMe Sanitization Tool

After you Sanitize SSD, all user data will be permanently destroyed on the SSD and cannot be recovered.

## Instant Flash

Save UEFI files in your USB storage device and run Instant Flash to update your UEFI.

## Intel MEI Flash

Starts BIOS recovery flash.

## Internet Flash - DHCP (Auto IP), Auto

ASRock Internet Flash downloads and updates the latest UEFI firmware version from our servers for you. Please setup network configuration before using Internet Flash.

\*For BIOS backup and recovery purpose, it is recommended to plug in your USB pen drive before using this function.

## Network Configuration

Use this to configure internet connection settings for Internet Flash.



## Internet Setting

Enable or disable sound effects in the setup utility.

## UEFI Download Server

Select a server to download the UEFI firmware.

## 4.8 Hardware Health Event Monitoring Screen

This section allows you to monitor the status of the hardware on your system, including the parameters of the CPU temperature, motherboard temperature, fan speed and voltage.

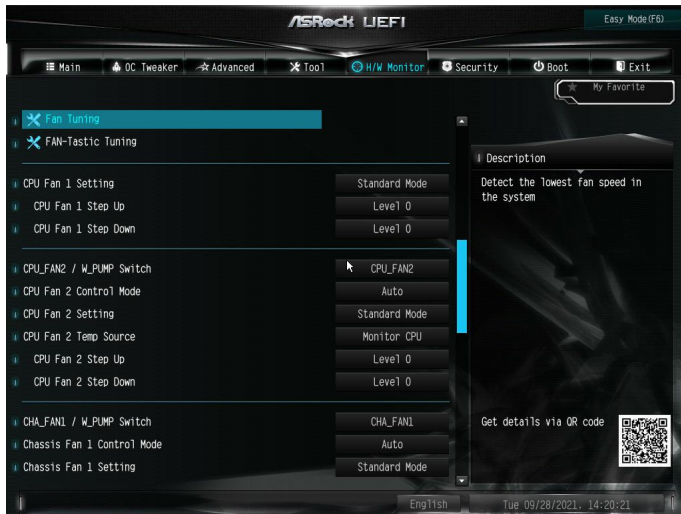

### Fan Tuning

Measure Fan Min Duty Cycle.

### Fan-Tastic Tuning

Select a fan mode for CPU Fan, or choose Customize to set 5 CPU temperatures and assign a respective fan speed for each temperature.

### CPU Fan 1 Setting

Select a fan mode for CPU Fan 1, or choose Customize to set 5 CPU temperatures and assign a respective fan speed for each temperature.

### CPU Fan 1 Step Up

Set the value of CPU Fan 1 Step Up.

### CPU Fan 1 Step Down

Set the value of CPU Fan 1 Step Down.

### CPU\_FAN2 / W\_PUMP Switch

Switch CPU\_FAN2 / W\_PUMP header function.



## CPU Fan 2 Control Mode

Select DC/PWM mode for CPU Fan 2.

## CPU Fan 2 Setting

Select a fan mode for CPU Fan 2, or choose Customize to set 5 CPU temperatures and assign a respective fan speed for each temperature.

## CPU Fan 2 Temp Source

Select a fan temperature source for CPU Fan 2.

## CPU Fan 2 Step Up

Set the value of CPU Fan 2 Step Up.

## CPU Fan 2 Step Down

Set the value of CPU Fan 2 Step Down.

## CHA\_FAN1 / W\_PUMP Switch

Select Chassis Fan 1 or Water Pump mode.

## Chassis Fan 1 Control Mode

Select PWM mode or DC mode for Chassis Fan 1.

## Chassis Fan 1 Setting

Select a fan mode for Chassis Fan 1, or choose Customize to set 5 CPU temperatures and assign a respective fan speed for each temperature.

## Chassis Fan 1 Temp Source

Select a fan temperature source for Chassis Fan 1.

## Chassis Fan 1 Step Up

Set the value of Chassis Fan 1 Step Up.

## Chassis Fan 1 Step Down

Set the value of Chassis Fan 1 Step Down.

## CHA\_FAN2 / W\_PUMP Switch

Select Chassis Fan 2 or Water Pump mode.

## Chassis Fan 2 Control Mode

Select PWM mode or DC mode for Chassis Fan 2.

## Chassis Fan 2 Setting

Select a fan mode for Chassis Fan 2, or choose Customize to set 5 CPU temperatures and assign a respective fan speed for each temperature.

## Chassis Fan 2 Temp Source

Select a fan temperature source for Chassis Fan 2.

## Chassis Fan 2 Step Up

Set the value of Chassis Fan 2 Step Up.

## Chassis Fan 2 Step Down

Set the value of Chassis Fan 2 Step Down.

## CHA\_FAN3 / W\_PUMP Switch

Select Chassis Fan 3 or Water Pump mode.

## Chassis Fan 3 Control Mode

Select PWM mode or DC mode for Chassis Fan 3.

## Chassis Fan 3 Setting

Select a fan mode for Chassis Fan 3, or choose Customize to set 5 CPU temperatures and assign a respective fan speed for each temperature.

## Chassis Fan 3 Temp Source

Select a fan temperature source for Chassis Fan 3.

## Chassis Fan 3 Step Up

Set the value of Chassis Fan 3 Step Up.

## Chassis Fan 3 Step Down

Set the value of Chassis Fan 3 Step Down.

## CHA\_FAN4 / W\_PUMP Switch

Select Chassis Fan 4 or Water Pump mode.

## Chassis Fan 4 Control Mode

Select PWM mode or DC mode for Chassis Fan 4.

## Chassis Fan 4 Setting

Select a fan mode for Chassis Fan 4, or choose Customize to set 5 CPU temperatures and assign a respective fan speed for each temperature.

### Chassis Fan 4 Temp Source

Select a fan temperature source for Chassis Fan 4.

### Chassis Fan 4 Step Up

Set the value of Chassis Fan 4 Step Up.

### Chassis Fan 4 Step Down

Set the value of Chassis Fan 4 Step Down.

## 4.9 Security Screen

In this section you may set or change the supervisor/user password for the system. You may also clear the user password.



### Supervisor Password

Set or change the password for the administrator account. Only the administrator has authority to change the settings in the UEFI Setup Utility. Leave it blank and press enter to remove the password.

### User Password

Set or change the password for the user account. Users are unable to change the settings in the UEFI Setup Utility. Leave it blank and press enter to remove the password.

### Secure Boot

Use this item to enable or disable support for Secure Boot.

### Intel(R) Platform Trust Technology

Enable/disable Intel PTT in ME. Disable this option to use discrete TPM Module.

## 4.10 Boot Screen

This section displays the available devices on your system for you to configure the boot settings and the boot priority.



### Fast Boot

Fast Boot minimizes your computer's boot time. In fast mode you may not boot from an USB storage device. The VBIOS must support UEFI GOP if you are using an external graphics card. Please notice that Ultra Fast mode will boot so fast that the only way to enter this UEFI Setup Utility is to Clear CMOS or run the Restart to UEFI utility in Windows.

### Boot From Onboard LAN

Allow the system to be waked up by the onboard LAN.

### Setup Prompt Timeout

Configure the number of seconds to wait for the setup hot key.

### Bootup Num-Lock

Select whether Num Lock should be turned on or off when the system boots up.

### Boot Beep

Select whether the Boot Beep should be turned on or off when the system boots up. Please note that a buzzer is needed.

## Full Screen Logo

Enable to display the boot logo or disable to show normal POST messages.

## AddOn ROM Display

Enable AddOn ROM Display to see the AddOn ROM messages or configure the AddOn ROM if you've enabled Full Screen Logo. Disable for faster boot speed.

## Boot Failure Guard Message

If the computer fails to boot for a number of times the system automatically restores the default settings.

## Boot Failure Guard Count

Configure the number of attempts to boot until the system automatically restores the default settings.

## CSM (Compatibility Support Module)

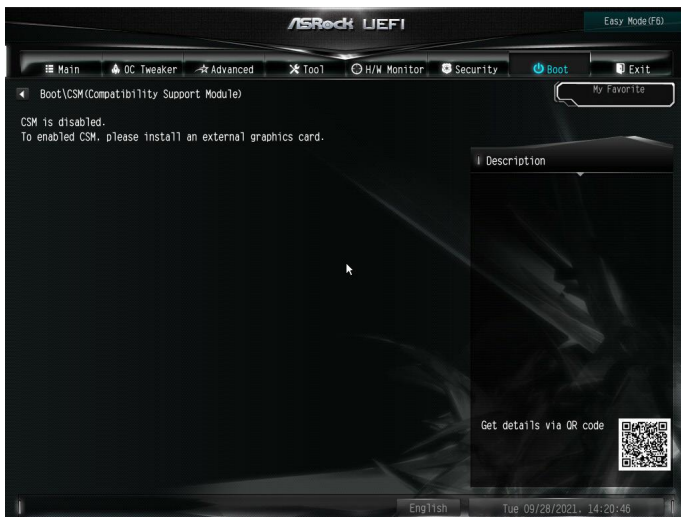

## CSM

Enable to launch the Compatibility Support Module. Please do not disable unless you're running a WHCK test.

## Launch PXE OpROM Policy

Select UEFI only to run those that support UEFI option ROM only. Select Legacy only to run those that support legacy option ROM only. Select Do not launch to not execute both legacy and UEFI option ROM.

### Launch Storage OpROM Policy

Select UEFI only to run those that support UEFI option ROM only. Select Legacy only to run those that support legacy option ROM only. Select Do not launch to not execute both legacy and UEFI option ROM.

### Other PCI Device ROM Priority

For PCI devices other than Network. Mass storage or Video defines which OpROM to launch.

## 4.11 Exit Screen



### Save Changes and Exit

When you select this option the following message, “Save configuration changes and exit setup?” will pop out. Select [OK] to save changes and exit the UEFI SETUP UTILITY.

### Discard Changes and Exit

When you select this option the following message, “Discard changes and exit setup?” will pop out. Select [OK] to exit the UEFI SETUP UTILITY without saving any changes.

### Discard Changes

When you select this option the following message, “Discard changes?” will pop out. Select [OK] to discard all changes.

### Load UEFI Defaults

Load UEFI default values for all options. The F9 key can be used for this operation.

### Launch EFI Shell from filesystem device

Copy shellx64.efi to the root directory to launch EFI Shell.



---

## Contact Information

If you need to contact ASRock or want to know more about ASRock, you're welcome to visit ASRock's website at <http://www.asrock.com>; or you may contact your dealer for further information. For technical questions, please submit a support request form at <http://www.asrock.com/support/tsd.asp>

### **ASRock Incorporation**

2F., No.37, Sec. 2, Jhongyang S. Rd., Beitou District,  
Taipei City 112, Taiwan (R.O.C.)

### **ASRock EUROPE B.V.**

Bijsterhuizen 11-11

6546 AR Nijmegen

The Netherlands

Phone: +31-24-345-44-33

Fax: +31-24-345-44-38

### **ASRock America, Inc.**

13848 Magnolia Ave, Chino, CA91710

U.S.A.

Phone: +1-909-590-8308

Fax: +1-909-590-1026

# DECLARATION OF CONFORMITY

Per FCC Part 2 Section 2.1077(a)



**Responsible Party Name:** ASRock Incorporation

**Address:** 13848 Magnolia Ave, Chino, CA91710

**Phone/Fax No:** +1-909-590-8308/+1-909-590-1026

hereby declares that the product

**Product Name :** Motherboard

**Model Number :** Z690-C/ac

Conforms to the following specifications:

FCC Part 15, Subpart B, Unintentional Radiators

## Supplementary Information:

This device complies with part 15 of the FCC Rules. Operation is subject to the following two conditions: (1) This device may not cause harmful interference, and (2) this device must accept any interference received, including interference that may cause undesired operation.

Representative Person's Name: Jason

Signature:

A handwritten signature in black ink, appearing to read 'Jason', written over a horizontal line.

Date : May 12, 2017

# EU Declaration of Conformity



For the following equipment:

**Motherboard**

(Product Name)

**Z690-C/ac / ASRock**

(Model Designation / Trade Name)

**ASRock Incorporation**

(Manufacturer Name)

**2F, No.37, Sec. 2, Jhongyang S. Rd., Beitou District, Taipei City 112, Taiwan (R.O.C.)**

(Manufacturer Address)

**Radio Equipment Directive - 2014/53/EU**

Article 3.1(b)

EN 301 489-1 V2.2.3, EN 301 489-17 V3.2.4, EN 55032: 2015 / A11: 2020

EN 55035: 2017 / A11: 2020, EN IEC 61000-3-2: 2019, EN 61000-3-3: 2013

Article 3.2

EN 300 328 V2.2.2, EN 300 440 V2.2.1, EN 301 893 V2.1.1

**RoHS Directive - 2011/65/EU**

2015/863/EU, EN IEC 63000:2018



(EU conformity marking)

**ASRock EUROPE B.V.**

(Company Name)

**Bijsterhuizen 1111 6546 AR Nijmegen The Netherlands**

(Company Address)

Person responsible for making this declaration:

(Name, Surname)

**A.V.P**

(Position / Title)

**October 24, 2021**

(Date)