



# Z68 Extreme4

## User Manual

Version 1.0

Published March 2011

Copyright©2011 ASRock INC. All rights reserved.

---

**Copyright Notice:**

No part of this installation guide may be reproduced, transcribed, transmitted, or translated in any language, in any form or by any means, except duplication of documentation by the purchaser for backup purpose, without written consent of ASRock Inc.

Products and corporate names appearing in this guide may or may not be registered trademarks or copyrights of their respective companies, and are used only for identification or explanation and to the owners' benefit, without intent to infringe.

**Disclaimer:**

Specifications and information contained in this guide are furnished for informational use only and subject to change without notice, and should not be constructed as a commitment by ASRock. ASRock assumes no responsibility for any errors or omissions that may appear in this guide.

With respect to the contents of this guide, ASRock does not provide warranty of any kind, either expressed or implied, including but not limited to the implied warranties or conditions of merchantability or fitness for a particular purpose. In no event shall ASRock, its directors, officers, employees, or agents be liable for any indirect, special, incidental, or consequential damages (including damages for loss of profits, loss of business, loss of data, interruption of business and the like), even if ASRock has been advised of the possibility of such damages arising from any defect or error in the guide or product.



This device complies with Part 15 of the FCC Rules. Operation is subject to the following two conditions:

- (1) this device may not cause harmful interference, and
- (2) this device must accept any interference received, including interference that may cause undesired operation.

**CALIFORNIA, USA ONLY**

The Lithium battery adopted on this motherboard contains Perchlorate, a toxic substance controlled in Perchlorate Best Management Practices (BMP) regulations passed by the California Legislature. When you discard the Lithium battery in California, USA, please follow the related regulations in advance.

"Perchlorate Material-special handling may apply, see

[www.dtsc.ca.gov/hazardouswaste/perchlorate](http://www.dtsc.ca.gov/hazardouswaste/perchlorate)"

The terms HDMI™ and HDMI High-Definition Multimedia Interface, and the HDMI logo are trademarks or registered trademarks of HDMI Licensing LLC in the United States and other countries.



---

# Contents

|  |           |
|--|-----------|
| <b>1 Introduction.....</b>   | <b>5</b>  |
| 1.1 Package Contents .....   | 5         |
| 1.2 Specifications.....  | 6         |
| 1.3 Motherboard Layout.....  | 13        |
| 1.4 I/O Panel .....  | 14        |
| <b>2 Installation.....</b>   | <b>16</b> |
| 2.1 Screw Holes.....   | 16        |
| 2.2 Pre-installation Precautions .....   | 16        |
| 2.3 CPU Installation .....   | 17        |
| 2.4 Installation of Heatsink and CPU fan .....   | 19        |
| 2.5 Installation of Memory Modules (DIMM).....   | 20        |
| 2.6 Expansion Slots (PCI and PCI Express Slots) .....  | 22        |
| 2.7 SLI™ and Quad SLI™ Operation Guide .....   | 23        |
| 2.8 CrossFireX™, 3-Way CrossFireX™ and Quad<br>CrossFireX™ Operation Guide .....                             | 27        |
| 2.9 Dual Monitor and Surround Display Features.....  | 33        |
| 2.10 ASRock Smart Remote Installation Guide .....  | 36        |
| 2.11 Jumpers Setup .....   | 37        |
| 2.12 Onboard Headers and Connectors .....  | 38        |
| 2.13 Smart Switches .....  | 44        |
| 2.14 Dr. Debug .....   | 45        |
| 2.15 Serial ATA (SATA) / Serial ATAII (SATAII) Hard Disks<br>Installation .....                              | 49        |
| 2.16 Serial ATA3 (SATA3) Hard Disks Installation .....   | 49        |
| 2.17 Hot Plug and Hot Swap Functions for SATA / SATAII<br>HDDs .....   | 50        |
| 2.18 Hot Plug and Hot Swap Functions for SATA3 HDDs ....   | 50        |
| 2.19 SATA / SATAII / SATA3 HDD Hot Plug Feature and<br>Operation Guide .....                                 | 51        |
| 2.20 Driver Installation Guide .....   | 53        |
| 2.21 Installing Windows® 7 / 7 64-bit / Vista™ / Vista™<br>64-bit / XP / XP 64-bit With RAID Functions ..... | 53        |
| 2.21.1 Installing Windows® XP / XP 64-bit With RAID<br>Functions.....  | 53        |
| 2.21.2 Setting Up a “RAID Ready” System.....   | 54        |
| 2.21.3 Migrating a “RAID Ready” System to RAID 0,<br>RAID 1 or RAID 5.....                                   | 55        |
| 2.21.4 Installing Windows® 7 / 7 64-bit / Vista™ /<br>Vista™ 64-bit With RAID Functions.....                 | 56        |

---

|  |           |
|--|-----------|
| 2.22 Installing Windows® 7 / 7 64-bit / Vista™ / Vista™ 64-bit / XP / XP 64-bit Without RAID Functions ..... | 57        |
| 2.22.1 Installing Windows® XP / XP 64-bit Without RAID Functions.....  | 57        |
| 2.22.2 Installing Windows® 7 / 7 64-bit / Vista™ / Vista™ 64-bit Without RAID Functions.....                 | 58        |
| <b>3 UEFI SETUP UTILITY .....</b>  | <b>59</b> |
| 3.1 Introduction.....  | 59        |
| 3.1.1 UEFI Menu Bar .....  | 59        |
| 3.1.2 Navigation Keys .....  | 60        |
| 3.2 Main Screen.....   | 60        |
| 3.3 OC Tweaker Screen .....  | 61        |
| 3.4 Advanced Screen.....   | 65        |
| 3.4.1 CPU Con guration .....   | 66        |
| 3.4.2 North Bridge Con guration.....   | 68        |
| 3.4.3 South Bridge Con guration.....   | 70        |
| 3.4.4 Storage Con guration .....   | 71        |
| 3.4.5 Super IO Con guration .....  | 72        |
| 3.4.6 ACPI Con guration.....   | 73        |
| 3.4.7 USB Con guration .....   | 74        |
| 3.5 Hardware Health Event Monitoring Screen .....  | 75        |
| 3.6 Boot Screen .....  | 76        |
| 3.7 Security Screen .....  | 77        |
| 3.8 Exit Screen .....  | 78        |
| <b>4 Software Support.....</b>   | <b>79</b> |
| 4.1 Install Operating System.....  | 79        |
| 4.2 Support CD Information .....   | 79        |
| 4.2.1 Running Support CD.....  | 79        |
| 4.2.2 Drivers Menu.....  | 79        |
| 4.2.3 Utilities Menu.....  | 79        |
| 4.2.4 Contact Information.....   | 79        |

---

## Chapter 1: Introduction

Thank you for purchasing ASRock **Z68 Extreme4** motherboard, a reliable motherboard produced under ASRock's consistently stringent quality control. It delivers excellent performance with robust design conforming to ASRock's commitment to quality and endurance.

In this manual, chapter 1 and 2 contain introduction of the motherboard and step-by-step guide to the hardware installation. Chapter 3 and 4 contain the configuration guide to BIOS setup and information of the Support CD.



Because the motherboard specifications and the BIOS software might be updated, the content of this manual will be subject to change without notice. In case any modifications of this manual occur, the updated version will be available on ASRock website without further notice. You may find the latest VGA cards and CPU support lists on ASRock website as well. ASRock website <http://www.asrock.com>  
If you require technical support related to this motherboard, please visit our website for specific information about the model you are using.  
[www.asrock.com/support/index.asp](http://www.asrock.com/support/index.asp)

### 1.1 Package Contents

ASRock **Z68 Extreme4** Motherboard

(ATX Form Factor: 12.0-in x 9.6-in, 30.5 cm x 24.4 cm)

ASRock **Z68 Extreme4** Quick Installation Guide

ASRock **Z68 Extreme4** Support CD

1 x Ribbon Cable for a 3.5-in Floppy Drive

4 x Serial ATA (SATA) Data Cables (Optional)

2 x Serial ATA (SATA) HDD Power Cables (Optional)

1 x 3.5mm Audio Cable (Optional)

1 x I/O Panel Shield

1 x Front USB 3.0 Panel

4 x HDD Screws

6 x Chassis Screws

1 x Rear USB 3.0 Bracket

1 x ASRock SLI\_Bridge\_2S Card



#### **ASRock Reminds You...**

To get better performance in Windows® 7 / 7 64-bit / Vista™ / Vista™ 64-bit, it is recommended to set the BIOS option in Storage Configuration to AHCI mode. For the BIOS setup, please refer to the "User Manual" in our support CD for details.

## 1.2 Specifications

|                       |  |
|-----------------------|--|
| <b>Platform</b>       | <ul style="list-style-type: none"> <li>- ATX Form Factor: 12.0-in x 9.6-in, 30.5 cm x 24.4 cm</li> <li>- All Solid Capacitor design (100% Japan-made high-quality Conductive Polymer Capacitors)</li> </ul>  |
| <b>CPU</b>            | <ul style="list-style-type: none"> <li>- Supports 2nd Generation Intel® Core™ i7 / i5 / i3 in LGA1155 Package</li> <li>- Advanced V8 Power Phase Design</li> <li>- Supports Intel® Turbo Boost 2.0 Technology</li> <li>- Supports K-Series unlocked CPU</li> <li>- Supports Hyper-Threading Technology (see <b>CAUTION 1</b>)</li> </ul>   |
| <b>Chipset</b>        | <ul style="list-style-type: none"> <li>- Intel® Z68</li> </ul>   |
| <b>Memory</b>         | <ul style="list-style-type: none"> <li>- Dual Channel DDR3 Memory Technology (see <b>CAUTION 2</b>)</li> <li>- 4 x DDR3 DIMM slots</li> <li>- Supports DDR3 2133(OC)/1866(OC)/1600/1333/1066 non-ECC, un-buffered memory (see <b>CAUTION 3</b>)</li> <li>- Max. capacity of system memory: 32GB (see <b>CAUTION 4</b>)</li> <li>- Supports Intel® Extreme Memory Profile (XMP)</li> </ul>  |
| <b>Expansion Slot</b> | <ul style="list-style-type: none"> <li>- 3 x PCI Express 2.0 x16 slots (PCIe2/PCIe4: single at x16 or dual at x8/x8 mode; PCIe5: x4 mode)</li> <li>- 2 x PCI Express 2.0 x1 slots</li> <li>- 2 x PCI slots</li> <li>- Supports ATI™ Quad CrossFireX™, 3-Way CrossFireX™ and CrossFireX™</li> <li>- Supports NVIDIA® Quad SLI™ and SLI™</li> </ul>  |
| <b>Graphics *</b>     | <ul style="list-style-type: none"> <li>* Requires Processor with Intel® Graphics Technology</li> <li>- Intel® HD Graphics 2000/3000</li> <li>- Pixel Shader 4.1, DirectX 10.1</li> <li>- Max. shared memory 1759MB (see <b>CAUTION 5</b>)</li> <li>- Four VGA Output options: D-Sub, DVI-D, HDMI and DisplayPort (see <b>CAUTION 6</b>)</li> <li>- Supports HDMI 1.4a Technology with max. resolution up to 1920x1200 @ 60Hz</li> <li>- Supports DVI with max. resolution up to 1920x1200 @ 60Hz</li> <li>- Supports D-Sub with max. resolution up to 2048x1536 @ 75Hz</li> <li>- Supports DisplayPort with max. resolution up to 2560x1600 @ 60Hz</li> <li>- Supports Auto Lip Sync, Deep Color (12bpc), xvYCC and HBR (High Bit Rate Audio) with HDMI (Compliant HDMI monitor is required) (see <b>CAUTION 7</b>)</li> </ul> |

---

|                       |   |
|-----------------------|---|
|                       | <ul style="list-style-type: none"> <li>- Supports Blu-ray Stereoscopic 3D with HDMI 1.4a</li> <li>- Supports HDCP function with DVI, HDMI and DisplayPort ports</li> <li>- Supports Full HD 1080p Blu-ray (BD) / HD-DVD playback with DVI, HDMI and DisplayPort ports</li> </ul>  |
| <b>Audio</b>          | <ul style="list-style-type: none"> <li>- 7.1 CH HD Audio with Content Protection (Realtek ALC892 Audio Codec)</li> <li>- Premium Blu-ray audio support</li> <li>- Supports THX TruStudio Pro™</li> </ul>  |
| <b>LAN</b>            | <ul style="list-style-type: none"> <li>- PCIE x1 Gigabit LAN 10/100/1000 Mb/s</li> <li>- Broadcom BCM57781</li> <li>- Supports Wake-On-LAN</li> <li>- Supports Energy Efficient Ethernet 802.3az</li> </ul>   |
| <b>Rear Panel I/O</b> | <p>I/O Panel</p> <ul style="list-style-type: none"> <li>- 1 x PS/2 Keyboard Port</li> <li>- 1 x VGA/D-Sub Port</li> <li>- 1 x VGA/DVI-D Port</li> <li>- 1 x HDMI Port</li> <li>- 1 x DisplayPort</li> <li>- 1 x Optical SPDIF Out Port</li> <li>- 4 x Ready-to-Use USB 2.0 Ports</li> <li>- 1 x eSATA3 Connector</li> <li>- 2 x Ready-to-Use USB 3.0 Ports</li> <li>- 1 x RJ-45 LAN Port with LED (ACT/LINK LED and SPEED LED)</li> <li>- 1 x IEEE 1394 Port</li> <li>- 1 x Clear CMOS Switch with LED</li> <li>- HD Audio Jack: Rear Speaker/Central/Bass/Line in/Front Speaker/Microphone (see <b>CAUTION 8</b>)</li> </ul> |
| <b>SATA3</b>          | <ul style="list-style-type: none"> <li>- 2 x SATA3 6.0 Gb/s connectors, support RAID (RAID 0, RAID 1, RAID 10, RAID 5, Intel Rapid Storage and Intel Smart Response Technology), NCQ, AHCI and "Hot Plug" functions</li> <li>- 2 x SATA3 6.0 Gb/s connectors by Marvell SE9120, support NCQ, AHCI and "Hot Plug" functions (SATA3_M2 connector is shared with eSATA3 port)</li> </ul>   |
| <b>USB3.0</b>         | <ul style="list-style-type: none"> <li>- 2 x Rear USB 3.0 ports by Etron EJ168A, support USB 1.0/2.0/3.0 up to 5Gb/s</li> <li>- 1 x Front USB 3.0 header (supports 2 USB 3.0 ports) by Etron EJ168A, supports USB 1.0/2.0/3.0 up to 5Gb/s</li> </ul>  |

---

|                       |  |
|-----------------------|--|
| <b>Connector</b>      | <ul style="list-style-type: none"> <li>- 4 x SATA2 3.0 Gb/s connectors, support RAID (RAID 0, RAID 1, RAID 10, RAID 5, Intel Rapid Storage and Intel Smart Response Technology), NCQ, AHCI and Hot Plug functions</li> <li>- 4 x SATA3 6.0Gb/s connectors</li> <li>- 1 x Floppy connector</li> <li>- 1 x IR header</li> <li>- 1 x CIR header</li> <li>- 1 x COM port header</li> <li>- 1 x HDMI_SPDIF header</li> <li>- 1 x IEEE 1394 header</li> <li>- 1 x Power LED header</li> <li>- CPU/Chassis/Power FAN connector</li> <li>- 24 pin ATX power connector</li> <li>- 8 pin 12V power connector</li> <li>- SLI/XFire power connector</li> <li>- Front panel audio connector</li> <li>- 3 x USB 2.0 headers (support 6 USB 2.0 ports)</li> <li>- 1 x USB 3.0 header (supports 2 USB 3.0 ports)</li> <li>- 1 x Dr. Debug (7-Segment Debug LED)</li> </ul> |
| <b>Smart Switch</b>   | <ul style="list-style-type: none"> <li>- 1 x Clear CMOS Switch with LED</li> <li>- 1 x Power Switch with LED</li> <li>- 1 x Reset Switch with LED</li> </ul>   |
| <b>BIOS Feature</b>   | <ul style="list-style-type: none"> <li>- 64Mb AMI BIOS</li> <li>- AMI UEFI Legal BIOS with GUI support</li> <li>- Supports "Plug and Play"</li> <li>- ACPI 1.1 Compliance Wake Up Events</li> <li>- Supports jumperfree</li> <li>- SMBIOS 2.3.1 Support</li> <li>- CPU Core, IGPU, DRAM, PCH, CPU PLL, VTT, VCCSA Voltage Multi-adjustment</li> </ul>  |
| <b>Support CD</b>     | <ul style="list-style-type: none"> <li>- Drivers, Utilities, AntiVirus Software (Trial Version), ASRock Software Suite (CyberLink DVD Suite - OEM and Trial)</li> </ul>  |
| <b>Unique Feature</b> | <ul style="list-style-type: none"> <li>- ASRock Extreme Tuning Utility (AXTU) (see <b>CAUTION 9</b>)</li> <li>- Instant Boot</li> <li>- ASRock Instant Flash (see <b>CAUTION 10</b>)</li> <li>- ASRock APP Charger (see <b>CAUTION 11</b>)</li> <li>- SmartView (see <b>CAUTION 12</b>)</li> <li>- ASRock XFast USB (see <b>CAUTION 13</b>)</li> <li>- Lucid Virtu (see <b>CAUTION 14</b>)</li> <li>- ASRock On/Off Play Technology (see <b>CAUTION 15</b>)</li> </ul>   |



---

|                         |  |
|-------------------------|--|
|                         | <ul style="list-style-type: none"> <li>- Hybrid Booster: <ul style="list-style-type: none"> <li>- CPU Frequency Stepless Control (see <b>CAUTION 16</b>)</li> <li>- ASRock U-COP (see <b>CAUTION 17</b>)</li> <li>- Boot Failure Guard (B.F.G.)</li> </ul> </li> <li>- Combo Cooler Option (C.C.O.) (see <b>CAUTION 18</b>)</li> <li>- Good Night LED</li> </ul>   |
| <b>Hardware Monitor</b> | <ul style="list-style-type: none"> <li>- CPU Temperature Sensing</li> <li>- Chassis Temperature Sensing</li> <li>- CPU/Chassis/Power Fan Tachometer</li> <li>- CPU/Chassis Quiet Fan (Allow Chassis Fan Speed Auto-Adjust by CPU Temperature)</li> <li>- CPU/Chassis Fan Multi-Speed Control</li> <li>- Voltage Monitoring: +12V, +5V, +3.3V, CPU Vcore</li> </ul> |
| <b>OS</b>               | <ul style="list-style-type: none"> <li>- Microsoft® Windows® 7 / 7 64-bit / Vista™ / Vista™ 64-bit / XP / XP 64-bit compliant</li> </ul>   |
| <b>Certifications</b>   | <ul style="list-style-type: none"> <li>- FCC, CE, WHQL</li> <li>- ErP/EuP Ready (ErP/EuP ready power supply is required) (see <b>CAUTION 19</b>)</li> </ul>  |

\* For detailed product information, please visit our website: <http://www.asrock.com>

**WARNING**

Please realize that there is a certain risk involved with overclocking, including adjusting the setting in the BIOS, applying Untied Overclocking Technology, or using the third-party overclocking tools. Overclocking may affect your system stability, or even cause damage to the components and devices of your system. It should be done at your own risk and expense. We are not responsible for possible damage caused by overclocking.

---

## **CAUTION!**

1. About the setting of "Hyper Threading Technology", please check page 66.
2. This motherboard supports Dual Channel Memory Technology. Before you implement Dual Channel Memory Technology, make sure to read the installation guide of memory modules on page 20 for proper installation.
3. DDR3 frequency options may depend on the processor. Only K-Series CPU can support DDR3 overclock to 2133 and 1866.
4. Due to the operating system limitation, the actual memory size may be less than 4GB for the reservation for system usage under Windows® 7 / Vista™ / XP. For Windows® OS with 64-bit CPU, there is no such limitation.
5. The maximum shared memory size is defined by the chipset vendor and is subject to change. Please check Intel® website for the latest information.
6. You can choose to use two of the four monitors only. D-Sub, DVI-D, HDMI and DisplayPort monitors cannot be enabled at the same time. Besides, with the DVI-to-HDMI adapter, the DVI-D port can support the same features as HDMI port.
7. xvYCC and Deep Color are only supported under Windows® 7 64-bit / 7. Deep Color mode will be enabled only if the display supports 12bpc in EDID. HBR is supported under Windows® 7 64-bit / 7 / Vista™ 64-bit / Vista™.
8. For microphone input, this motherboard supports both stereo and mono modes. For audio output, this motherboard supports 2-channel, 4-channel, 6-channel, and 8-channel modes. Please check the table on page 14 for proper connection.
9. ASRock Extreme Tuning Utility (AXTU) is an all-in-one tool to fine-tune different system functions in a user-friendly interface, which is including Hardware Monitor, Fan Control, Overclocking, OC DNA and IES. In Hardware Monitor, it shows the major readings of your system. In Fan Control, it shows the fan speed and temperature for you to adjust. In Overclocking, you are allowed to overclock CPU frequency for optimal system performance. In OC DNA, you can save your OC settings as a profile and share with your friends. Your friends then can load the OC profile to their own system to get the same OC settings. In IES (Intelligent Energy Saver), the voltage regulator can reduce the number of output phases to improve efficiency when the CPU cores are idle without sacrificing computing performance. Please visit our website for the operation procedures of ASRock Extreme Tuning Utility (AXTU).  
ASRock website: <http://www.asrock.com>

- 
10. ASRock Instant Flash is a BIOS flash utility embedded in Flash ROM. This convenient BIOS update tool allows you to update system BIOS without entering operating systems first like MS-DOS or Windows®. With this utility, you can press <F6> key during the POST or press <F2> key to BIOS setup menu to access ASRock Instant Flash. Just launch this tool and save the new BIOS file to your USB flash drive, floppy disk or hard drive, then you can update your BIOS only in a few clicks without preparing an additional floppy diskette or other complicated flash utility. Please be noted that the USB flash drive or hard drive must use FAT32/16/12 file system.
  11. If you desire a faster, less restricted way of charging your Apple devices, such as iPhone/iPod/iPad Touch, ASRock has prepared a wonderful solution for you - ASRock APP Charger. Simply installing the APP Charger driver, it makes your iPhone charged much quickly from your computer and up to 40% faster than before. ASRock APP Charger allows you to quickly charge many Apple devices simultaneously and even supports continuous charging when your PC enters into Standby mode (S1), Suspend to RAM (S3), hibernation mode (S4) or power off (S5). With APP Charger driver installed, you can easily enjoy the marvelous charging experience than ever.  
ASRock website: <http://www.asrock.com/Feature/AppCharger/index.asp>
  12. SmartView, a new function of internet browser, is the smart start page for IE that combines your most visited web sites, your history, your Facebook friends and your real-time newsfeed into an enhanced view for a more personal Internet experience. ASRock motherboards are exclusively equipped with the SmartView utility that helps you keep in touch with friends on-the-go. To use SmartView feature, please make sure your OS version is Windows® 7 / 7 64 bit / Vista™ / Vista™ 64 bit, and your browser version is IE8. ASRock website: <http://www.asrock.com/Feature/SmartView/index.asp>
  13. ASRock XFast USB can boost USB storage device performance. The performance may depend on the property of the device.
  14. With Lucid Virtu technology, you can enjoy benefits from both 3D performance of the discrete GPU and advanced media features of Intel® HD graphics.
  15. ASRock On/Off Play Technology allows users to enjoy the great audio experience from the portable audio devices, such like MP3 player or mobile phone to your PC, even when the PC is turned off (or in ACPI S5 mode)! This motherboard also provides a free 3.5mm audio cable (optional) that ensures users the most convenient computing environment.
  16. Although this motherboard offers stepless control, it is not recommended to perform over-clocking. Frequencies other than the recommended CPU bus frequencies may cause the instability of the system or damage the CPU.

- 
17. While CPU overheat is detected, the system will automatically shutdown. Before you resume the system, please check if the CPU fan on the motherboard functions properly and unplug the power cord, then plug it back again. To improve heat dissipation, remember to spray thermal grease between the CPU and the heatsink when you install the PC system.
  18. Combo Cooler Option (C.C.O.) provides the flexible option to adopt three different CPU cooler types, Socket LGA 775, LGA 1155 and LGA 1156. Please be noticed that not all the 775 and 1156 CPU Fan can be used.
  19. EuP, stands for Energy Using Product, was a provision regulated by European Union to define the power consumption for the completed system. According to EuP, the total AC power of the completed system shall be under 1.00W in off mode condition. To meet EuP standard, an EuP ready motherboard and an EuP ready power supply are required. According to Intel's suggestion, the EuP ready power supply must meet the standard of 5v standby power efficiency is higher than 50% under 100 mA current consumption. For EuP ready power supply selection, we recommend you checking with the power supply manufacturer for more details.

### 1.3 Motherboard Layout

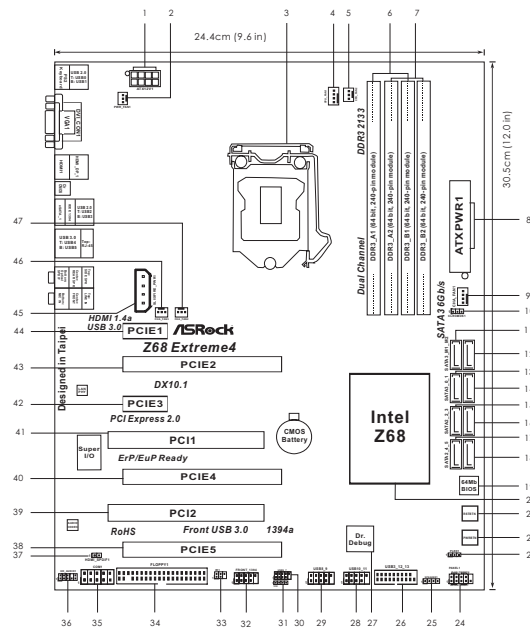

- |    |  |    |   |
|----|--|----|---|
| 1  | ATX 12V Power Connector (ATX12V1)                                      | 26 | USB 3.0 Header (USB3_12_13, Light Blue)             |
| 2  | Power Fan Connector (PWR_FAN1)   | 27 | Dr. Debug   |
| 3  | 1155-Pin CPU Socket  | 28 | USB 2.0 Header (USB10_11, Blue)                     |
| 4  | CPU Fan Connector (CPU_FAN1)   | 29 | USB 2.0 Header (USB8_9, Blue)                       |
| 5  | CPU Fan Connector (CPU_FAN2)   | 30 | USB 2.0 Header (USB6_7, Blue)                       |
| 6  | 2 x 240-pin DDR3 DIMM Slots<br>(Dual Channel: DDR3_A1, DDR3_B1, Blue)  | 31 | Consumer Infrared Module Header<br>(CIR1)           |
| 7  | 2 x 240-pin DDR3 DIMM Slots<br>(Dual Channel: DDR3_A2, DDR3_B2, White) | 32 | Front Panel IEEE 1394 Header<br>(FRONT_1394, White) |
| 8  | ATX Power Connector (ATXPWR1)  | 33 | Infrared Module Header (IR1)                        |
| 9  | Chassis Fan Connector (CHA_FAN1)                                       | 34 | Floppy Connector (FLOPPY1)                          |
| 10 | Clear CMOS Jumper (CLRCMOS1)   | 35 | COM Port Header (COM1)                              |
| 11 | SATA3 Connector (SATA3_M1, White)                                      | 36 | Front Panel Audio Header<br>(HD_AUDIO1, White)      |
| 12 | SATA3 Connector (SATA3_M2, White)                                      | 37 | HDMI_SPDIF Header<br>(HDMI_SPDIF1, White)           |
| 13 | SATA3 Connector (SATA3_0, White)                                       | 38 | PCI Express 2.0 x16 Slot (PCIE5, Blue)              |
| 14 | SATA3 Connector (SATA3_1, White)                                       | 39 | PCI Slot (PCI2)                                     |
| 15 | SATA2 Connector (SATA2_2, Blue)  | 40 | PCI Express 2.0 x16 Slot (PCIE4, Blue)              |
| 16 | SATA2 Connector (SATA2_3, Blue)  | 41 | PCI Slot (PCI1)                                     |
| 17 | SATA2 Connector (SATA2_4, Blue)  | 42 | PCI Express 2.0 x1 Slot (PCIE3, White)              |
| 18 | SATA2 Connector (SATA2_5, Blue)  | 43 | PCI Express 2.0 x16 Slot (PCIE2, Blue)              |
| 19 | 64Mb SPI Flash   | 44 | PCI Express 2.0 x1 Slot (PCIE1, White)              |
| 20 | Intel Z68 Chipset  | 45 | SLI/XFIRE Power Connector                           |
| 21 | Reset Switch (RSTBTN)  | 46 | Chassis Fan Connector (CHA_FAN3)                    |
| 22 | Power Switch (PWRBTN)  | 47 | Chassis Fan Connector (CHA_FAN2)                    |
| 23 | Power LED Header (PLED1)   |    |   |
| 24 | System Panel Header (PANEL1, White)                                    |    |   |
| 25 | Chassis Speaker Header (SPEAKER 1, White)                              |    |   |

## 1.4 I/O Panel

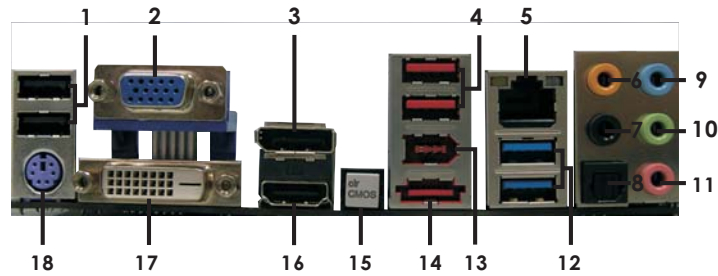

- |     |                         |       |                             |
|-----|-------------------------|-------|-----------------------------|
| 1   | USB 2.0 Ports (USB01)   | ** 10 | Front Speaker (Lime)        |
| 2   | VGA/D-Sub Port          | 11    | Microphone (Pink)           |
| 3   | DisplayPort (HDMI_DP_1) | 12    | USB 3.0 Ports (USB45)       |
| 4   | USB 2.0 Ports (USB23)   | 13    | IEEE 1394 Port (IEEE 1394)  |
| * 5 | LAN RJ-45 Port          | ** 14 | eSATA3 Connector            |
| 6   | Central / Bass (Orange) | 15    | Clear CMOS Switch (CLRBTN)  |
| 7   | Rear Speaker (Black)    | 16    | VGA/HDMI Port               |
| 8   | Optical SPDIF Out Port  | 17    | VGA/DVI-D Port              |
| 9   | Line In (Light Blue)    | 18    | PS/2 Keyboard Port (Purple) |

\* There are two LED next to the LAN port. Please refer to the table below for the LAN port LED indications.

### LAN Port LED Indications

| Activity/Link LED |               | SPEED LED |                    |  |
|-------------------|---------------|-----------|--------------------|--|
| Status            | Description   | Status    | Description        | <p>ACT/LINK LED    SPEED LED</p> <p>LAN Port</p> |
| Off               | No Link       | Off       | 10Mbps connection  |  |
| Blinking          | Data Activity | Orange    | 100Mbps connection |  |
| On                | Link          | Green     | 1Gbps connection   |  |

\*\* If you use 2-channel speaker, please connect the speaker's plug into "Front Speaker Jack".  
See the table below for connection details in accordance with the type of speaker you use.

### TABLE for Audio Output Connection

| Audio Output Channels | Front Speaker<br>(No. 10) | Rear Speaker<br>(No. 7) | Central / Bass<br>(No. 6) | Line In or<br>Side Speaker<br>(No. 9) |
|-----------------------|---------------------------|-------------------------|---------------------------|---------------------------------------|
| 2                     | V                         | --                      | --                        | --                                    |
| 4                     | V                         | V                       | --                        | --                                    |
| 6                     | V                         | V                       | V                         | --                                    |
| 8                     | V                         | V                       | V                         | V                                     |

---

To enable Multi-Streaming function, you need to connect a front panel audio cable to the front panel audio header. After restarting your computer, you will find "Mixer" tool on your system. Please select "Mixer ToolBox" , click "Enable playback multi-streaming", and click "ok". Choose "2CH", "4CH", "6CH", or "8CH" and then you are allowed to select "Realtek HDA Primary output" to use Rear Speaker, Central/Bass, and Front Speaker, or select "Realtek HDA Audio 2nd output" to use front panel audio.

\*\*\* eSATA3 connector supports SATA Gen3 in cable 1M.

---

## Chapter 2: Installation

This is an ATX form factor (12.0" x 9.6", 30.5 x 24.4 cm) motherboard. Before you install the motherboard, study the configuration of your chassis to ensure that the motherboard fits into it.



Make sure to unplug the power cord before installing or removing the motherboard. Failure to do so may cause physical injuries to you and damages to motherboard components.

### 2.1 Screw Holes

Place screws into the holes indicated by circles to secure the motherboard to the chassis.



Do not over-tighten the screws! Doing so may damage the motherboard.

### 2.2 Pre-installation Precautions

Take note of the following precautions before you install motherboard components or change any motherboard settings.

1. Unplug the power cord from the wall socket before touching any component.
2. To avoid damaging the motherboard components due to static electricity, NEVER place your motherboard directly on the carpet or the like. Also remember to use a grounded wrist strap or touch a safety grounded object before you handle components.
3. Hold components by the edges and do not touch the ICs.
4. Whenever you uninstall any component, place it on a grounded antistatic pad or in the bag that comes with the component.



Before you install or remove any component, ensure that the power is switched off or the power cord is detached from the power supply. Failure to do so may cause severe damage to the motherboard, peripherals, and/or components.



---

## 2.3 CPU Installation

For the installation of Intel 1155-Pin CPU, please follow the steps below.

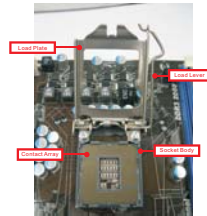

1155-Pin Socket Overview



Before you insert the 1155-Pin CPU into the socket, please check if the CPU surface is unclean or if there is any bent pin on the socket. Do not force to insert the CPU into the socket if above situation is found. Otherwise, the CPU will be seriously damaged.

### Step 1. Open the socket:

Step 1-1. Disengaging the lever by depressing down and out on the hook to clear retention tab.



Step 1-2. Rotate the load lever to fully open position at approximately 135 degrees.

Step 1-3. Rotate the load plate to fully open position at approximately 100 degrees.



### Step 2. Remove PnP Cap (Pick and Place Cap).



1. It is recommended to use the cap tab to handle and avoid kicking off the PnP cap.
2. This cap must be placed if returning the motherboard for after service.

---

Step 3. Insert the 1155-Pin CPU:

Step 3-1. Hold the CPU by the edge where is marked with black line.



Step 3-2. Orient the CPU with IHS (Integrated Heat Sink) up. Locate Pin1 and the two orientation key notches.

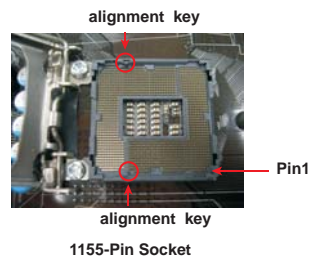
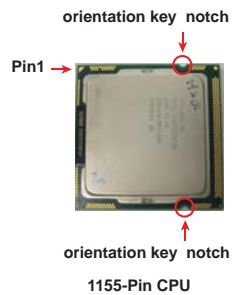

For proper inserting, please ensure to match the two orientation key notches of the CPU with the two alignment keys of the socket.

Step 3-3. Carefully place the CPU into the socket by using a purely vertical motion.



Step 3-4. Verify that the CPU is within the socket and properly mated to the orientation keys.

Step 4. Close the socket:

Step 4-1. Rotate the load plate onto the IHS.

Step 4-2. While pressing down lightly on load plate, engage the load lever.



## 2.4 Installation of CPU Fan and Heatsink

This motherboard is equipped with 1155-Pin socket that supports Intel 1155-Pin CPU. Please adopt the type of heatsink and cooling fan compliant with Intel 1155-Pin CPU to dissipate heat. Before you installed the heatsink, you need to spray thermal interface material between the CPU and the heatsink to improve heat dissipation. Ensure that the CPU and the heatsink are securely fastened and in good contact with each other. Then connect the CPU fan to the CPU\_FAN connector (CPU\_FAN1, see page 13, No. 4).

**For proper installation, please kindly refer to the instruction manuals of your CPU fan and heatsink.**

Below is an example to illustrate the installation of the heatsink for 1155-Pin CPU.

Step 1. Apply thermal interface material onto center of IHS on the socket surface.



Step 2. Place the heatsink onto the socket. Ensure fan cables are oriented on side closest to the CPU fan connector on the motherboard (CPU\_FAN1, see page 13, No. 4).

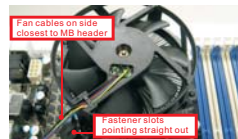

Step 3. Align fasteners with the motherboard through-holes.

Step 4. Rotate the fastener clockwise, then press down on fastener caps with thumb to install and lock. Repeat with remaining fasteners.



If you press down the fasteners without rotating them clockwise, the heatsink cannot be secured on the motherboard.

Step 5. Connect fan header with the CPU fan connector on the motherboard.

Step 6. Secure excess cable with tie-wrap to ensure cable does not interfere with fan operation or contact other components.



Please be noticed that this motherboard supports Combo Cooler Option (C.C.O.), which provides the flexible option to adopt three different CPU cooler types, Socket LGA 775, LGA 1155 and LGA 1156. The white throughholes are for Socket LGA 1155/1156 CPU fan.



---

## 2.5 Installation of Memory Modules (DIMM)

This motherboard provides four 240-pin DDR3 (Double Data Rate 3) DIMM slots, and supports Dual Channel Memory Technology. For dual channel configuration, you always need to install **identical** (the same brand, speed, size and chip-type) DDR3 DIMM pair in the slots of the same color. In other words, you have to install **identical** DDR3 DIMM pair in **Dual Channel A** (DDR3\_A1 and DDR3\_B1; Blue slots; see p.13 No.6) or **identical** DDR3 DIMM pair in **Dual Channel B** (DDR3\_A2 and DDR3\_B2; White slots; see p.13 No.7), so that Dual Channel Memory Technology can be activated. This motherboard also allows you to install four DDR3 DIMMs for dual channel configuration, and please install **identical** DDR3 DIMMs in all four slots. You may refer to the Dual Channel Memory Configuration Table below.

**Dual Channel Memory Configurations**

|      | DDR3_A1<br>(Blue Slot) | DDR3_A2<br>(White Slot) | DDR3_B1<br>(Blue Slot) | DDR3_B2<br>(White Slot) |
|------|------------------------|-------------------------|------------------------|-------------------------|
| (1)  | Populated              | -                       | Populated              | -                       |
| (2)  | -                      | Populated               | -                      | Populated               |
| (3)* | Populated              | Populated               | Populated              | Populated               |

\* For the configuration (3), please install **identical** DDR3 DIMMs in all four slots.



1. If you want to install two memory modules, for optimal compatibility and reliability, it is recommended to install them in the slots of the same color. In other words, install them either in the set of blue slots (DDR3\_A1 and DDR3\_B1), or in the set of white slots (DDR3\_A2 and DDR3\_B2).
2. If only one memory module or three memory modules are installed in the DDR3 DIMM slots on this motherboard, it is unable to activate the Dual Channel Memory Technology.
3. If a pair of memory modules is NOT installed in the same Dual Channel, for example, installing a pair of memory modules in DDR3\_A1 and DDR3\_A2, it is unable to activate the Dual Channel Memory Technology.
4. It is not allowed to install a DDR or DDR2 memory module into DDR3 slot; otherwise, this motherboard and DIMM may be damaged.
5. Some DDR3 1GB double-sided DIMMs with 16 chips may not work on this motherboard. It is not recommended to install them on this motherboard.

---

## Installing a DIMM



Please make sure to disconnect power supply before adding or removing DIMMs or the system components.

- Step 1. Unlock a DIMM slot by pressing the retaining clips outward.  
Step 2. Align a DIMM on the slot such that the notch on the DIMM matches the break on the slot.

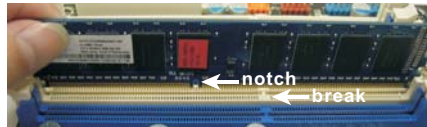

The DIMM only fits in one correct orientation. It will cause permanent damage to the motherboard and the DIMM if you force the DIMM into the slot at incorrect orientation.

- Step 3. Firmly insert the DIMM into the slot until the retaining clips at both ends fully snap back in place and the DIMM is properly seated.

---

## 2.6 Expansion Slots (PCI and PCI Express Slots)

There are 2 PCI slots and 5 PCI Express slots on this motherboard.

**PCI slots:** PCI slots are used to install expansion cards that have the 32-bit PCI interface.

**PCIe slots:**

PCIe1 / PCIe3 (PCIe x1 slot; White) is used for PCI Express cards with x1 lane width cards, such as Gigabit LAN card, SATA2 card, etc.

PCIe2 / PCIe4 (PCIe x16 slot; Blue) is used for PCI Express x16 lane width graphics cards, or used to install PCI Express graphics cards to support CrossFireX™ or SLI™ function.

PCIe5 (PCIe x16 slot; Blue) is used for PCI Express x4 lane width graphics cards, or used to install PCI Express graphics cards to support 3-Way CrossFireX™ function.



1. In single VGA card mode, it is recommended to install a PCI Express x16 graphics card on PCIe2 slot.
2. In CrossFireX™ mode or SLI™ mode, please install PCI Express x16 graphics cards on PCIe2 and PCIe4 slots. Therefore, both these two slots will work at x8 bandwidth.
3. In 3-Way CrossFireX™ mode, please install PCI Express x16 graphics cards on PCIe2, PCIe4 and PCIe5 slots. Therefore, PCIe2 and PCIe4 slots will work at x8 bandwidth while PCIe5 slot will work at x4 bandwidth.
4. Please connect a chassis fan to motherboard chassis fan connector (CHA\_FAN1, CHA\_FAN2 or CHA\_FAN3) when using multiple graphics cards for better thermal environment.

### Installing an expansion card

- Step 1. Before installing the expansion card, please make sure that the power supply is switched off or the power cord is unplugged. Please read the documentation of the expansion card and make necessary hardware settings for the card before you start the installation.
- Step 2. Remove the system unit cover (if your motherboard is already installed in a chassis).
- Step 3. Remove the bracket facing the slot that you intend to use. Keep the screws for later use.
- Step 4. Align the card connector with the slot and press firmly until the card is completely seated on the slot.
- Step 5. Fasten the card to the chassis with screws.
- Step 6. Replace the system cover.

---

## 2.7 SLI™ and Quad SLI™ Operation Guide

This motherboard supports NVIDIA® SLI™ and Quad SLI™ (Scalable Link Interface) technology that allows you to install up to three identical PCI Express x16 graphics cards. Currently, NVIDIA® SLI™ technology supports Windows® XP / XP 64-bit / Vista™ / Vista™ 64-bit / 7 / 7 64-bit OS. NVIDIA® Quad SLI™ technology support Windows® Vista™ / Vista™ 64-bit / 7 / 7 64-bit OS only. Please follow the installation procedures in this section.



### Requirements

1. For SLI™ technology, you should have two identical SLI™-ready graphics cards that are NVIDIA® certified. For Quad SLI™ technology, you should have two identical Quad SLI™-ready graphics cards that are NVIDIA® certified.
2. Make sure that your graphics card driver supports NVIDIA® SLI™ technology. Download the driver from NVIDIA® website ([www.nvidia.com](http://www.nvidia.com)).
3. Make sure that your power supply unit (PSU) can provide at least the minimum power required by your system. It is recommended to use NVIDIA® certified PSU. Please refer to NVIDIA® website for details.

### 2.7.1 Graphics Card Setup

#### 2.7.1.1 Installing Two SLI™-Ready Graphics Cards

Step 1. Install the identical SLI™-ready graphics cards that are NVIDIA® certified because different types of graphics cards will not work together properly. (Even the GPU chips version shall be the same.) Insert one graphics card into PCIE2 slot and the other graphics card to PCIE4 slot. Make sure that the cards are properly seated on the slots.



Step2. If required, connect the auxiliary power source to the PCI Express graphics cards.

---

Step3. Align and insert ASRock SLI\_Bridge\_2S Card to the gold fingers on each graphics card. Make sure ASRock SLI\_Bridge\_2S Card is firmly in place.



ASRock SLI\_Bridge\_2S Card

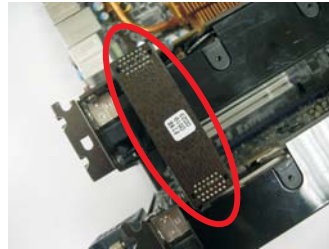

Step4. Connect a VGA cable or a DVI cable to the monitor connector or the DVI connector of the graphics card that is inserted to PCIE2 slot.



---

## 2.7.2 Driver Installation and Setup

Install the graphics card drivers to your system. After that, you can enable the Multi-Graphics Processing Unit (GPU) feature in the NVIDIA® nView system tray utility. Please follow the below procedures to enable the multi-GPU feature.

### For Windows® XP / XP 64-bit OS: (For SLI™ mode only)

A. Double-click **NVIDIA Settings** icon on your Windows® taskbar.



B. From the pop-up menu, select **Set SLI and PhysX configuration**. In **Set PhysX GPU acceleration** item, please select **Enabled**. In **Select an SLI configuration** item, please select **Enable SLI**. And click **Apply**.

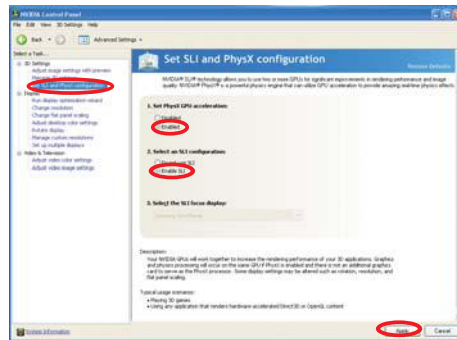

C. Reboot your system.

D. You can freely enjoy the benefit of SLI™ feature.

---

**For Windows® Vista™ / Vista™ 64-bit / 7 / 7 64-bit OS:  
(For SLI™ and Quad SLI™ mode)**

- A. Click the **Start** icon on your Windows taskbar.
- B. From the pop-up menu, select **All Programs**, and then click **NVIDIA Corporation**.
- C. Select **NVIDIA Control Panel** tab.
- D. Select **Control Panel** tab.

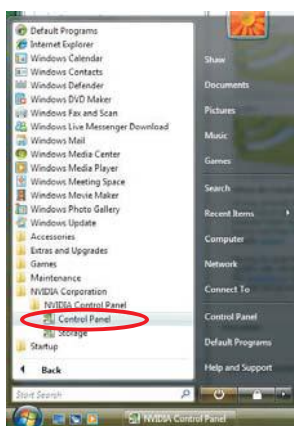

- E. From the pop-up menu, select **Set SLI and PhysX configuration**. In **Set PhysX GPU acceleration** item, please select **Enabled**. In **Select an SLI configuration** item, please select **Enable SLI**. And click **Apply**.

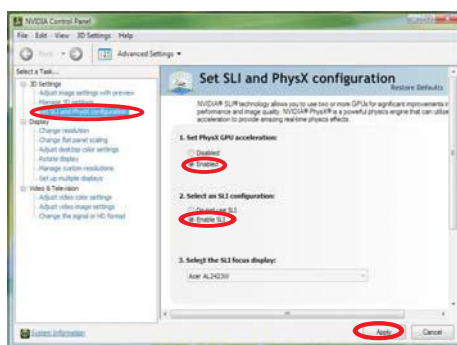

- F. Reboot your system.
- G. You can freely enjoy the benefit of SLI™ or Quad SLI™ feature.

\* SLI™ appearing here is a registered trademark of NVIDIA® Technologies Inc., and is used only for identification or explanation and to the owners' benefit, without intent to infringe.

---

## 2.8 CrossFireX™, 3-Way CrossFireX™ and Quad CrossFireX™ Operation Guide

This motherboard supports CrossFireX™, 3-way CrossFireX™ and Quad CrossFireX™ feature. CrossFireX™ technology offers the most advantageous means available of combining multiple high performance Graphics Processing Units (GPU) in a single PC. Combining a range of different operating modes with intelligent software design and an innovative interconnect mechanism, CrossFireX™ enables the highest possible level of performance and image quality in any 3D application. Currently CrossFireX™ feature is supported with Windows® XP with Service Pack 2 / Vista™ / 7 OS. 3-way CrossFireX™ and Quad CrossFireX™ feature are supported with Windows® Vista™ / 7 OS only. Please check AMD website for ATI™ CrossFireX™ driver updates.



1. If a customer incorrectly configures their system they will not see the performance benefits of CrossFireX™. All three CrossFireX™ components, a CrossFireX™ Ready graphics card, a CrossFireX™ Ready motherboard and a CrossFireX™ Edition co-processor graphics card, must be installed correctly to benefit from the CrossFireX™ multi-GPU platform.
2. If you pair a 12-pipe CrossFireX™ Edition card with a 16-pipe card, both cards will operate as 12-pipe cards while in CrossFireX™ mode.

### 2.8.1 Graphics Card Setup

#### 2.8.1.1 Installing Two CrossFireX™-Ready Graphics Cards



Different CrossFireX™ cards may require different methods to enable CrossFireX™ feature. In below procedures, we use Radeon HD 3870 as the example graphics card. For other CrossFireX™ cards that ATI™ has released or will release in the future, please refer to ATI™ graphics card manuals for detailed installation guide.

- Step 1. Insert one Radeon graphics card into PCIE2 slot and the other Radeon graphics card to PCIE4 slot. Make sure that the cards are properly seated on the slots.

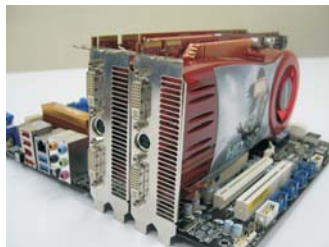

- 
- Step 2. Connect two Radeon graphics cards by installing CrossFire Bridge on CrossFire Bridge Interconnects on the top of Radeon graphics cards. (CrossFire Bridge is provided with the graphics card you purchase, not bundled with this motherboard. Please refer to your graphics card vendor for details.)



**CrossFire Bridge**

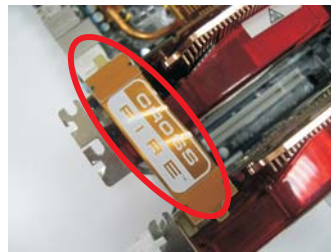

or

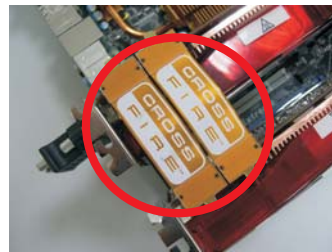

- Step 3. Connect the DVI monitor cable to the DVI connector on the Radeon graphics card on PCIE2 slot. (You may use the DVI to D-Sub adapter to convert the DVI connector to D-Sub interface, and then connect the D-Sub monitor cable to the DVI to D-Sub adapter.)

---

### 2.8.1.2 Installing Three CrossFire™-Ready Graphics Cards

Step 1. Install one Radeon graphics card to PCIE2 slot. For the proper installation procedures, please refer to section “Expansion Slots”.



Step 2. Install one Radeon graphics card to PCIE4 slot. For the proper installation procedures, please refer to section “Expansion Slots”.



Step 3. Install one Radeon graphics card to PCIE5 slot. For the proper installation procedures, please refer to section “Expansion Slots”.



Step 4. Use one CrossFire™ Bridge to connect Radeon graphics cards on PCIE2 and PCIE4 slots, and use the other CrossFire™ Bridge to connect Radeon graphics cards on PCIE4 and PCIE5 slots. (CrossFire™ Bridge is provided with the graphics card you purchase, not bundled with this motherboard. Please refer to your graphics card vendor for details.)



CrossFire™ Bridge



- Step 5. Connect the DVI monitor cable to the DVI connector on the Radeon graphics card on PCIE2 slot. (You may use the DVI to D-Sub adapter to convert the DVI connector to D-Sub interface, and then connect the D-Sub monitor cable to the DVI to D-Sub adapter.)

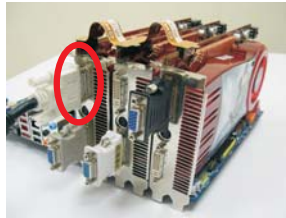

---

## 2.8.2 Driver Installation and Setup

Step 1. Power on your computer and boot into OS.

Step 2. Remove the ATI™ driver if you have any VGA driver installed in your system.



The Catalyst Uninstaller is an optional download. We recommend using this utility to uninstall any previously installed Catalyst drivers prior to installation. Please check AMD website for ATI™ driver updates.

Step 3. Install the required drivers to your system.

### For Windows® XP OS:

A. ATI™ recommends Windows® XP Service Pack 2 or higher to be installed (If you have Windows® XP Service Pack 2 or higher installed in your system, there is no need to download it again):

<http://www.microsoft.com/windowsxp/sp2/default.msp>

B. You must have Microsoft .NET Framework installed prior to downloading and installing the CATALYST Control Center. Please check Microsoft website for details.

### For Windows® 7 / Vista™ OS:

Install the CATALYST Control Center. Please check AMD website for details.

Step 4. Restart your computer.

Step 5. Install the VGA card drivers to your system, and restart your computer.

Then you will find “ATI Catalyst Control Center” on your Windows® taskbar.



ATI Catalyst Control Center

Step 6. Double-click “ATI Catalyst Control Center”. Click “View”, select “CrossFireX™”, and then check the item “Enable CrossFireX™”. Select “2 GPUs” and click “Apply” (if you install two Radeon graphics cards). Select “3 GPUs” and click “OK” (if you install three Radeon graphics cards).

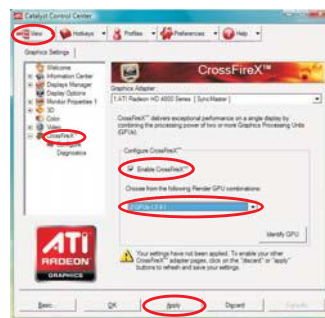



Although you have selected the option "Enable CrossFire™", the CrossFireX™ function may not work actually. Your computer will automatically reboot. After restarting your computer, please confirm whether the option "Enable CrossFire™" in "ATI Catalyst Control Center" is selected or not; if not, please select it again, and then you are able to enjoy the benefit of CrossFireX™ feature.

Step 7. You can freely enjoy the benefit of CrossFireX™, 3-Way CrossFireX™ or Quad CrossFireX™ feature.

- \* CrossFireX™ appearing here is a registered trademark of ATI™ Technologies Inc., and is used only for identification or explanation and to the owners' benefit, without intent to infringe.
- \* For further information of ATI™ CrossFireX™ technology, please check AMD website for updates and details.



---

## 2.9 Dual Monitor and Surround Display Features

### Dual Monitor Feature

This motherboard supports dual monitor feature. With the internal VGA output support (DVI-D, D-Sub, HDMI and DisplayPort), you can easily enjoy the benefits of dual monitor feature without installing any add-on VGA card to this motherboard. This motherboard also provides independent display controllers for DVI-D, D-Sub, HDMI and DisplayPort to support dual VGA output so that DVI-D, D-sub, HDMI and DisplayPort can drive same or different display contents.

To enable dual monitor feature, please follow the below steps:

1. Connect DVI-D monitor cable to VGA/DVI-D port on the I/O panel, connect D-Sub monitor cable to VGA/D-Sub port on the I/O panel, connect HDMI monitor cable to HDMI port on the I/O panel, or connect DisplayPort monitor cable to DisplayPort on the I/O panel.

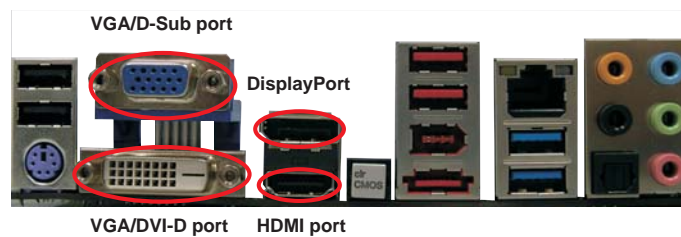

2. If you have installed onboard VGA driver from our support CD to your system already, you can freely enjoy the benefits of dual monitor function after your system boots. If you haven't installed onboard VGA driver yet, please install onboard VGA driver from our support CD to your system and restart your computer.



D-Sub, DVI-D, HDMI and DisplayPort monitors cannot be enabled at the same time. You can only choose two of them.

---

### Surround Display Feature

This motherboard supports surround display upgrade. With the internal VGA output support (DVI-D, D-Sub, HDMI and DisplayPort) and external add-on PCI Express VGA cards, you can easily enjoy the benefits of surround display feature.

Please refer to the following steps to set up a surround display environment:

1. Install the PCI Express VGA cards on PCIE2, PCIE4 and PCIE5 slots. Please refer to page 22 for proper expansion card installation procedures for details.
2. Connect DVI-D monitor cable to VGA/DVI-D port on the I/O panel, connect D-Sub monitor cable to VGA/D-Sub port on the I/O panel, connect HDMI monitor cable to HDMI port on the I/O panel, or connect DisplayPort monitor cable to DisplayPort on the I/O panel. Then connect other monitor cables to the corresponding connectors of the add-on PCI Express VGA cards on PCIE2, PCIE4 and PCIE5 slots.
3. Boot your system. Press <F2> or <Del> to enter UEFI setup. Enter "Onboard VGA Share Memory" option to adjust the memory capability to [32MB], [64MB], [128MB], [256MB] or [512MB] to enable the function of VGA/D-sub. Please make sure that the value you select is less than the total capability of the system memory. If you do not adjust the UEFI setup, the default value of "Onboard VGA Share Memory", [Auto], will disable VGA/D-Sub function when the add-on VGA card is inserted to this motherboard.
4. Install the onboard VGA driver and the add-on PCI Express VGA card driver to your system. If you have installed the drivers already, there is no need to install them again.
5. Set up a multi-monitor display.

#### For Windows® XP / XP 64-bit OS:

Right click the desktop, choose "Properties", and select the "Settings" tab so that you can adjust the parameters of the multi-monitor according to the steps below.

- A. Click the "Identify" button to display a large number on each monitor.
- B. Right-click the display icon in the Display Properties dialog that you wish to be your primary monitor, and then select "Primary". When you use multiple monitors with your card, one monitor will always be Primary, and all additional monitors will be designated as Secondary.
- C. Select the display icon identified by the number 2.
- D. Click "Extend my Windows desktop onto this monitor".
- E. Right-click the display icon and select "Attached", if necessary.
- F. Set the "Screen Resolution" and "Color Quality" as appropriate for the second monitor. Click "Apply" or "OK" to apply these new values.
- G. Repeat steps C through E for the display icon identified by the number one to eight.

---

**For Windows® 7 / 7 64-bit / Vista™ / Vista™ 64-bit OS:**

Right click the desktop, choose “Personalize”, and select the “Display Settings” tab so that you can adjust the parameters of the multi-monitor according to the steps below.

A. Click the number “2” icon.

B. Click the items “This is my main monitor” and “Extend the desktop onto this monitor”.

C. Click “OK” to save your change.

D. Repeat steps A through C for the display icon identified by the number three to eight.

6. Use Surround Display. Click and drag the display icons to positions representing the physical setup of your monitors that you would like to use. The placement of display icons determines how you move items from one monitor to another.



**HDCP Function**

HDCP function is supported on this motherboard. To use HDCP function with this motherboard, you need to adopt the monitor that supports HDCP function as well. Therefore, you can enjoy the superior display quality with high-definition HDCP encryption contents. Please refer to below instruction for more details about HDCP function.

**What is HDCP?**

HDCP stands for High-Bandwidth Digital Content Protection, a specification developed by Intel® for protecting digital entertainment content that uses the DVI interface. HDCP is a copy protection scheme to eliminate the possibility of intercepting digital data midstream between the video source, or transmitter - such as a computer, DVD player or set-top box - and the digital display, or receiver - such as a monitor, television or projector. In other words, HDCP specification is designed to protect the integrity of content as it is being transmitted.

Products compatible with the HDCP scheme such as DVD players, satellite and cable HDTV set-top-boxes, as well as few entertainment PCs requires a secure connection to a compliant display. Due to the increase in manufacturers employing HDCP in their equipment, it is highly recommended that the HDTV or LCD monitor you purchase is compatible.

---

## 2.10 ASRock Smart Remote Installation Guide

ASRock Smart Remote is only used for ASRock motherboard with CIR header. Please refer to below procedures for the quick installation and usage of ASRock Smart Remote.

Step1. Find the CIR header located next to the USB 2.0 header on ASRock motherboard.



Step2. Connect the front USB cable to the USB 2.0 header (as below, pin 1-5) and the CIR header. Please make sure the wire assignments and the pin assignments are matched correctly.

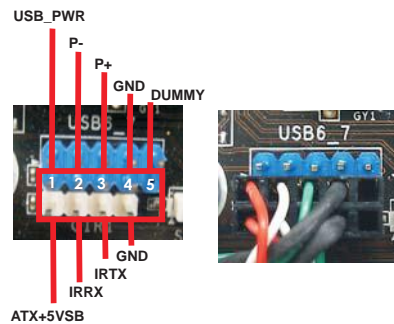

Step3. Install Multi-Angle CIR Receiver to the front USB port. If Multi-Angle CIR Receiver cannot successfully receive the infrared signals from MCE Remote Controller, please try to install it to the other front USB port.



3 CIR sensors in different angles





1. Only one of the front USB port can support CIR function. When the CIR function is enabled, the other port will remain USB function.
2. Multi-Angle CIR Receiver is used for front USB only. Please do not use the rear USB bracket to connect it on the rear panel. Multi-Angle CIR Receiver can receive the multi-direction infrared signals (top, down and front), which is compatible with most of the chassis on the market.
3. The Multi-Angle CIR Receiver does not support Hot-Plug function. Please install it before you boot the system.

\* ASRock Smart Remote is only supported by some of ASRock motherboards. Please refer to ASRock website for the motherboard support list: <http://www.asrock.com>

## 2.11 Jumpers Setup

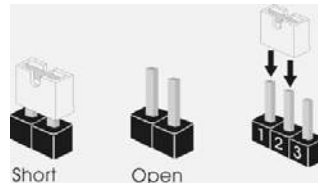
The illustration shows how jumpers are setup. When the jumper cap is placed on pins, the jumper is "Short". If no jumper cap is placed on pins, the jumper is "Open". The illustration shows a 3-pin jumper whose pin1 and pin2 are "Short" when jumper cap is placed on these 2 pins.



| Jumper  | Setting   | Description |
|---|---|-------------|
| Clear CMOS Jumper<br>(CLRCMOS1)<br>(see p.13, No. 10) | <div style="display: flex; justify-content: space-around;"> <div style="text-align: center;"> <b>1_2</b><br/> <br/>           Default         </div> <div style="text-align: center;"> <b>2_3</b><br/> <br/>           Clear CMOS         </div> </div> |             |

Note: CLRCMOS1 allows you to clear the data in CMOS. To clear and reset the system parameters to default setup, please turn off the computer and unplug the power cord from the power supply. After waiting for 15 seconds, use a jumper cap to short pin2 and pin3 on CLRCMOS1 for 5 seconds. However, please do not clear the CMOS right after you update the BIOS. If you need to clear the CMOS when you just finish updating the BIOS, you must boot up the system first, and then shut it down before you do the clear-CMOS action. Please be noted that the password, date, time, user default profile, 1394 GUID and MAC address will be cleared only if the CMOS battery is removed.



The Clear CMOS Switch has the same function as the Clear CMOS jumper.

## 2.12 Onboard Headers and Connectors



Onboard headers and connectors are NOT jumpers. Do NOT place jumper caps over these headers and connectors. Placing jumper caps over the headers and connectors will cause permanent damage of the motherboard!

### FDD connector

(33-pin FLOPPY1)  
(see p.13 No. 34)



Note: Make sure the red-striped side of the cable is plugged into Pin1 side of the connector.

### Serial ATAII Connectors

(SATA2\_2: see p.13, No. 15)  
(SATA2\_3: see p.13, No. 16)  
(SATA2\_4: see p.13, No. 17)  
(SATA2\_5: see p.13, No. 18)

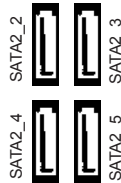

These four Serial ATAII (SATAII) connectors support SATA data cables for internal storage devices. The current SATAII interface allows up to 3.0 Gb/s data transfer rate.

### Serial ATA3 Connectors

(SATA3\_0: see p.13, No. 13)  
(SATA3\_1: see p.13, No. 14)  
(SATA3\_M1: see p.13, No. 11)  
(SATA3\_M2: see p.13, No. 12)

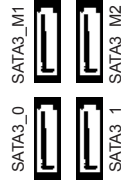

These four Serial ATA3 (SATA3) connectors support SATA data cables for internal storage devices. The current SATA3 interface allows up to 6.0 Gb/s data transfer rate. If you install the HDD on the eSATA port on the rear I/O, the internal SATA3\_M2 will not function.

### Serial ATA (SATA)

Data Cable  
(Optional)



Either end of the SATA data cable can be connected to the SATA / SATAII / SATA3 hard disk or the SATAII / SATA3 connector on this motherboard.

### Serial ATA (SATA)

Power Cable  
(Optional)

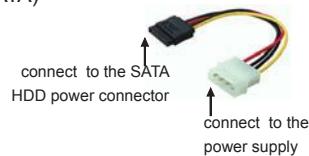

Please connect the black end of SATA power cable to the power connector on each drive. Then connect the white end of SATA power cable to the power connector of the power supply.

**3.5mm Audio Cable**  
(Optional)



Either end of the 3.5mm audio cable can be connected to the portable audio devices, such as MP3 player and mobile phone or the Line-in port of your PC.

**USB 2.0 Headers**  
(9-pin USB6\_7)  
(see p.13 No. 30)

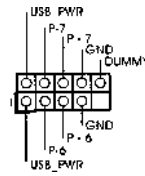

(9-pin USB8\_9)  
(see p.13 No. 29)

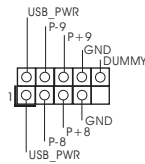

(9-pin USB10\_11)  
(see p.13 No. 28)

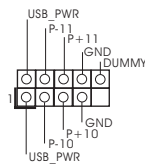

Besides four default USB 2.0 ports on the I/O panel, there are three USB 2.0 headers on this motherboard. Each USB 2.0 header can support two USB 2.0 ports.

**USB 3.0 Header**  
(19-pin USB3\_12\_13)  
(see p.13 No. 26)

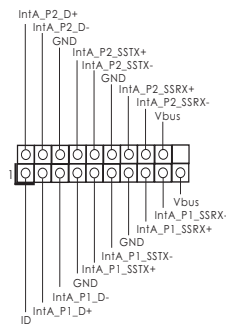

Besides two default USB 3.0 ports on the I/O panel, there is one USB 3.0 header on this motherboard. This USB 3.0 header can support two USB 3.0 ports.

**Infrared Module Header**  
(5-pin IR1)  
(see p.13 No. 33)

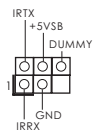

This header supports an optional wireless transmitting and receiving infrared module.

**Consumer Infrared Module Header**  
(4-pin CIR1)  
(see p.13 No. 31)



This header can be used to connect the remote controller receiver.

### Front Panel Audio Header

(9-pin HD\_AUDIO1)

(see p.13 No. 36)

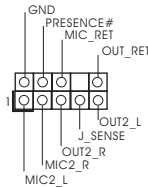

This is an interface for front panel audio cable that allows convenient connection and control of audio devices.



1. High Definition Audio supports Jack Sensing, but the panel wire on the chassis must support HDA to function correctly. Please follow the instruction in our manual and chassis manual to install your system.
2. If you use AC'97 audio panel, please install it to the front panel audio header as below:
  - A. Connect Mic\_IN (MIC) to MIC2\_L.
  - B. Connect Audio\_R (RIN) to OUT2\_R and Audio\_L (LIN) to OUT2\_L.
  - C. Connect Ground (GND) to Ground (GND).
  - D. MIC\_RET and OUT\_RET are for HD audio panel only. You don't need to connect them for AC'97 audio panel.
  - E. To activate the front mic.  
For Windows® XP / XP 64-bit OS:  
Select "Mixer". Select "Recorder". Then click "FrontMic".  
For Windows® 7 / 7 64-bit / Vista™ / Vista™ 64-bit OS:  
Go to the "FrontMic" Tab in the Realtek Control panel. Adjust "Recording Volume".

### System Panel Header

(9-pin PANEL1)

(see p.13 No. 24)

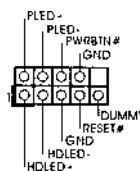

This header accommodates several system front panel functions.



Connect the power switch, reset switch and system status indicator on the chassis to this header according to the pin assignments below. Note the positive and negative pins before connecting the cables.

#### **PWRBTN (Power Switch):**

Connect to the power switch on the chassis front panel. You may configure the way to turn off your system using the power switch.

#### **RESET (Reset Switch):**

Connect to the reset switch on the chassis front panel. Press the reset switch to restart the computer if the computer freezes and fails to perform a normal restart.

#### **PLED (System Power LED):**

Connect to the power status indicator on the chassis front panel. The LED is on when the system is operating. The LED keeps blinking when the system is in S1 sleep state. The LED is off when the system is in S3/S4 sleep state or powered off (S5).



**HDLED (Hard Drive Activity LED):**

Connect to the hard drive activity LED on the chassis front panel. The LED is on when the hard drive is reading or writing data.

The front panel design may differ by chassis. A front panel module mainly consists of power switch, reset switch, power LED, hard drive activity LED, speaker and etc. When connecting your chassis front panel module to this header, make sure the wire assignments and the pin assignments are matched correctly.

**Chassis Speaker Header**

(4-pin SPEAKER 1)  
(see p.13 No. 25)

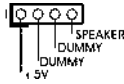

Please connect the chassis speaker to this header.

**Power LED Header**

(3-pin PLED1)  
(see p.13 No. 23)



Please connect the chassis power LED to this header to indicate system power status. The LED is on when the system is operating. The LED keeps blinking in S1 state. The LED is off in S3/S4 state or S5 state (power off).

**Chassis and Power Fan Connectors**

(4-pin CHA\_FAN1)  
(see p.13 No. 9)



Please connect the fan cables to the fan connectors and match the black wire to the ground pin.

(3-pin CHA\_FAN2)  
(see p.13 No. 47)

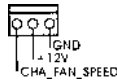

(3-pin CHA\_FAN3)  
(see p.13 No. 46)

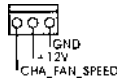

(3-pin PWR\_FAN1)  
(see p.13 No. 2)



**CPU Fan Connectors**

(4-pin CPU\_FAN1)  
(see p.13 No. 4)

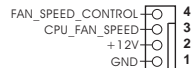

Please connect the CPU fan cable to the connector and match the black wire to the ground pin.



Though this motherboard provides 4-Pin CPU fan (Quiet Fan) support, the 3-Pin CPU fan still can work successfully even without the fan speed control function. If you plan to connect the 3-Pin CPU fan to the CPU fan connector on this motherboard, please connect it to Pin 1-3.

**Pin 1-3 Connected** ←  
3-Pin Fan Installation

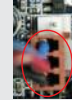

(3-pin CPU\_FAN2)  
(see p.13 No. 5)



**ATX Power Connector**  
(24-pin ATXPWR1)  
(see p.13 No. 8)

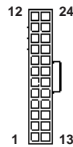

Please connect an ATX power supply to this connector.



Though this motherboard provides 24-pin ATX power connector, it can still work if you adopt a traditional 20-pin ATX power supply. To use the 20-pin ATX power supply, please plug your power supply along with Pin 1 and Pin 13.

20-Pin ATX Power Supply Installation

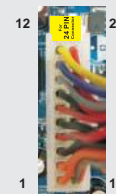

**ATX 12V Power Connector**  
(8-pin ATX12V1)  
(see p.13 No. 1)



Please connect an ATX 12V power supply to this connector.



Though this motherboard provides 8-pin ATX 12V power connector, it can still work if you adopt a traditional 4-pin ATX 12V power supply. To use the 4-pin ATX power supply, please plug your power supply along with Pin 1 and Pin 5.

4-Pin ATX 12V Power Supply Installation

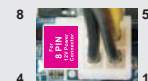

**SLI/XFIRE Power Connector**  
(4-pin SLI/XFIRE\_PWR1)  
(see p.13 No. 45)



SLI/XFIRE\_POWER1

It is not necessary to use this connector, but please connect it with a hard disk power connector when two graphics cards are plugged to this motherboard.

**IEEE 1394 Header**  
 (9-pin FRONT\_1394)  
 (see p.13 No. 32)

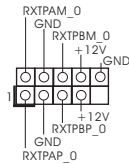

Besides one default IEEE 1394 port on the I/O panel, there is one IEEE 1394 header (FRONT\_1394) on this motherboard. This IEEE 1394 header can support one IEEE 1394 port.

**Serial port Header**  
 (9-pin COM1)  
 (see p.13 No. 35)

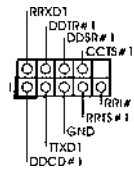

This COM1 header supports a serial port module.

**HDMI\_SPDIF Header**  
 (2-pin HDMI\_SPDIF1)  
 (see p.13 No. 37)



HDMI\_SPDIF header, providing SPDIF audio output to HDMI VGA card, allows the system to connect HDMI Digital TV/ projector/LCD devices. Please connect the HDMI\_SPDIF connector of HDMI VGA card to this header.

### The Installation Guide of Front USB 3.0 Panel

**Step 1** Prepare the bundled Front USB 3.0 Panel, four HDD screws, and six chassis screws.



**Step 2** Screw the 2.5" HDD/SSD to the Front USB 3.0 Panel with four HDD screws.



**Step 3** Install the Front USB 3.0 Panel into the 2.5" drive bay of the chassis.



**Step 4** Screw the Front USB 3.0 Panel to the drive bay with six chassis screws.



---

**Step 5** Plug the Front USB 3.0 cable into the USB 3.0 header (USB3\_12\_13) on the motherboard.



**Step 6** The Front USB 3.0 Panel is ready to use.



### The Installation Guide of Rear USB 3.0 Bracket

**Step 1** Unscrew the two screws from the Front USB 3.0 Panel.



**Step 2** Put the USB 3.0 cable and the rear USB 3.0 bracket together.



**Step 3** Screw the two screws into the rear USB 3.0 bracket.



**Step 4** Put the rear USB 3.0 bracket into the chassis.



---

### 2.13 Smart Switches

The motherboard has three smart switches: power switch, reset switch and clear CMOS switch, allowing users to quickly turn on/off or reset the system clear the CMOS values.

---

Power Switch  
(PWRBTN)  
(see p.13 No. 22)



Power Switch is a smart switch, allowing users to quickly turn on/off the system.

---

Reset Switch  
(RSTBTN)  
(see p.13 No. 21)



Reset Switch is a smart switch, allowing users to quickly reset the system.

---

Clear CMOS Switch  
(CLRBTN)  
(see p.14 No. 15)



Clear CMOS Switch is a smart switch, allowing users to quickly clear the CMOS values.

---

---

## 2.14 Dr. Debug

Dr. Debug is used to provide code information, which makes troubleshooting even easier. Please see the diagrams below for reading the Dr. Debug codes.

| Status Code | Description  |
|-------------|--|
| 0x00        | Not used   |
| 0x01        | Power on. Reset type detection (soft/hard)                                   |
| 0x02        | AP initialization before microcode loading                                   |
| 0x03        | North Bridge initialization before microcode loading                         |
| 0x04        | South Bridge initialization before microcode loading                         |
| 0x05        | OEM initialization before microcode loading                                  |
| 0x06        | Microcode loading  |
| 0x07        | AP initialization after microcode loading                                    |
| 0x08        | North Bridge initialization after microcode loading                          |
| 0x09        | South Bridge initialization after microcode loading                          |
| 0x0A        | OEM initialization after microcode loading                                   |
| 0x0B        | Cache initialization   |
| 0x0C – 0x0D | Reserved for future AMI SEC error codes                                      |
| 0x0E        | Microcode not found  |
| 0x0F        | Microcode not loaded   |
| 0x10        | PEI Core is started  |
| 0x11        | Pre-memory CPU initialization is started                                     |
| 0x12        | Pre-memory CPU initialization (CPU module specific)                          |
| 0x13        | Pre-memory CPU initialization (CPU module specific)                          |
| 0x14        | Pre-memory CPU initialization (CPU module specific)                          |
| 0x15        | Pre-memory North Bridge initialization is started                            |
| 0x16        | Pre-Memory North Bridge initialization (North Bridge module specific)        |
| 0x17        | Pre-Memory North Bridge initialization (North Bridge module specific)        |
| 0x18        | Pre-Memory North Bridge initialization (North Bridge module specific)        |
| 0x19        | Pre-memory South Bridge initialization is started                            |
| 0x1A        | Pre-memory South Bridge initialization (South Bridge module specific)        |
| 0x1B        | Pre-memory South Bridge initialization (South Bridge module specific)        |
| 0x1C        | Pre-memory South Bridge initialization (South Bridge module specific)        |
| 0x1D – 0x2A | OEM pre-memory initialization codes  |
| 0x2B        | Memory initialization. Serial Presence Detect (SPD) data reading             |
| 0x2C        | Memory initialization. Memory presence detection                             |
| 0x2D        | Memory initialization. Programming memory timing information                 |
| 0x2E        | Memory initialization. Configuring memory                                    |
| 0x2F        | Memory initialization (other)  |
| 0x30        | Reserved for ASL (see ASL Status Codes section below)                        |
| 0x31        | Memory Installed   |
| 0x32        | CPU post-memory initialization is started                                    |
| 0x33        | CPU post-memory initialization. Cache initialization                         |
| 0x34        | CPU post-memory initialization. Application Processor(s) (AP) initialization |
| 0x35        | CPU post-memory initialization. Boot Strap Processor (BSP) selection         |
| 0x36        | CPU post-memory initialization. System Management Mode (SMM) initialization  |

---

---

|             |   |
|-------------|---|
| 0x37        | Post-Memory North Bridge initialization is started                              |
| 0x38        | Post-Memory North Bridge initialization (North Bridge module speci c)           |
| 0x39        | Post-Memory North Bridge initialization (North Bridge module speci c)           |
| 0x3A        | Post-Memory North Bridge initialization (North Bridge module speci c)           |
| 0x3B        | Post-Memory South Bridge initialization is started                              |
| 0x3C        | Post-Memory South Bridge initialization (South Bridge module speci c)           |
| 0x3D        | Post-Memory South Bridge initialization (South Bridge module speci c)           |
| 0x3E        | Post-Memory South Bridge initialization (South Bridge module speci c)           |
| 0x3F-0x4E   | OEM post memory initialization codes  |
| 0x4F        | DXE IPL is started  |
| 0x50        | Memory initialization error. Invalid memory type or incompatible memory speed   |
| 0x51        | Memory initialization error. SPD reading has failed                             |
| 0x52        | Memory initialization error. Invalid memory size or memory modules do not match |
| 0x53        | Memory initialization error. No usable memory detected                          |
| 0x54        | Unspeci ed memory initialization error  |
| 0x55        | Memory not installed  |
| 0x56        | Invalid CPU type or Speed   |
| 0x57        | CPU mismatch  |
| 0x58        | CPU self test failed or possible CPU cache error                                |
| 0x59        | CPU micro-code is not found or micro-code update is failed                      |
| 0x5A        | Internal CPU error  |
| 0x5B        | reset PPI is not available  |
| 0x5C-0x5F   | Reserved for future AMI error codes   |
| 0xE0        | S3 Resume is started (S3 Resume PPI is called by the DXE IPL)                   |
| 0xE1        | S3 Boot Script execution  |
| 0xE2        | Video repost  |
| 0xE3        | OS S3 wake vector call  |
| 0xE4-0xE7   | Reserved for future AMI progress codes  |
| 0xE8        | S3 Resume Failed  |
| 0xE9        | S3 Resume PPI not Found   |
| 0xEA        | S3 Resume Boot Script Error   |
| 0xEB        | S3 OS Wake Error  |
| 0xEC-0xEF   | Reserved for future AMI error codes   |
| 0xF0        | Recovery condition triggered by rmware (Auto recovery)                          |
| 0xF1        | Recovery condition triggered by user (Forced recovery)                          |
| 0xF2        | Recovery process started  |
| 0xF3        | Recovery rmware image is found  |
| 0xF4        | Recovery rmware image is loaded   |
| 0xF5-0xF7   | Reserved for future AMI progress codes  |
| 0xF8        | Recovery PPI is not available   |
| 0xF9        | Recovery capsule is not found   |
| 0xFA        | Invalid recovery capsule  |
| 0xFB – 0xFF | Reserved for future AMI error codes   |
| 0x60        | DXE Core is started   |
| 0x61        | NVRAM initialization  |

---

---

|             |   |
|-------------|---|
| 0x62        | Installation of the South Bridge Runtime Services             |
| 0x63        | CPU DXE initialization is started                             |
| 0x64        | CPU DXE initialization (CPU module speci c)                   |
| 0x65        | CPU DXE initialization (CPU module speci c)                   |
| 0x66        | CPU DXE initialization (CPU module speci c)                   |
| 0x67        | CPU DXE initialization (CPU module speci c)                   |
| 0x68        | PCI host bridge initialization                                |
| 0x69        | North Bridge DXE initialization is started                    |
| 0x6A        | North Bridge DXE SMM initialization is started                |
| 0x6B        | North Bridge DXE initialization (North Bridge module speci c) |
| 0x6C        | North Bridge DXE initialization (North Bridge module speci c) |
| 0x6D        | North Bridge DXE initialization (North Bridge module speci c) |
| 0x6E        | North Bridge DXE initialization (North Bridge module speci c) |
| 0x6F        | North Bridge DXE initialization (North Bridge module speci c) |
| 0x70        | South Bridge DXE initialization is started                    |
| 0x71        | South Bridge DXE SMM initialization is started                |
| 0x72        | South Bridge devices initialization                           |
| 0x73        | South Bridge DXE Initialization (South Bridge module speci c) |
| 0x74        | South Bridge DXE Initialization (South Bridge module speci c) |
| 0x75        | South Bridge DXE Initialization (South Bridge module speci c) |
| 0x76        | South Bridge DXE Initialization (South Bridge module speci c) |
| 0x77        | South Bridge DXE Initialization (South Bridge module speci c) |
| 0x78        | ACPI module initialization                                    |
| 0x79        | CSM initialization  |
| 0x7A – 0x7F | Reserved for future AMI DXE codes                             |
| 0x80 – 0x8F | OEM DXE initialization codes                                  |
| 0x90        | Boot Device Selection (BDS) phase is started                  |
| 0x91        | Driver connecting is started                                  |
| 0x92        | PCI Bus initialization is started                             |
| 0x93        | PCI Bus Hot Plug Controller Initialization                    |
| 0x94        | PCI Bus Enumeration   |
| 0x95        | PCI Bus Request Resources                                     |
| 0x96        | PCI Bus Assign Resources                                      |
| 0x97        | Console Output devices connect                                |
| 0x98        | Console input devices connect                                 |
| 0x99        | Super IO Initialization                                       |
| 0x9A        | USB initialization is started                                 |
| 0x9B        | USB Reset   |
| 0x9C        | USB Detect  |
| 0x9D        | USB Enable  |
| 0x9E – 0x9F | Reserved for future AMI codes                                 |
| 0xA0        | IDE initialization is started                                 |
| 0xA1        | IDE Reset   |
| 0xA2        | IDE Detect  |
| 0xA3        | IDE Enable  |
| 0xA4        | SCSI initialization is started                                |
| 0xA5        | SCSI Reset  |

---

---

|             |   |
|-------------|---|
| 0xA6        | SCSI Detect   |
| 0xA7        | SCSI Enable   |
| 0xA8        | Setup Verifying Password                              |
| 0xA9        | Start of Setup  |
| 0xAA        | Reserved for ASL (see ASL Status Codes section below) |
| 0xAB        | Setup Input Wait                                      |
| 0xAC        | Reserved for ASL (see ASL Status Codes section below) |
| 0xAD        | Ready To Boot event                                   |
| 0xAE        | Legacy Boot event                                     |
| 0xAF        | Exit Boot Services event                              |
| 0xB0        | Runtime Set Virtual Address MAP Begin                 |
| 0xB1        | Runtime Set Virtual Address MAP End                   |
| 0xB2        | Legacy Option ROM Initialization                      |
| 0xB3        | System Reset  |
| 0xB4        | USB hot plug  |
| 0xB5        | PCI bus hot plug                                      |
| 0xB6        | Clean-up of NVRAM                                     |
| 0xB7        | Configuration Reset (reset of NVRAM settings)         |
| 0xB8 – 0xBF | Reserved for future AMI codes                         |
| 0xC0 – 0xCF | OEM BDS initialization codes                          |
| 0xD0        | CPU initialization error                              |
| 0xD1        | North Bridge initialization error                     |
| 0xD2        | South Bridge initialization error                     |
| 0xD3        | Some of the Architectural Protocols are not available |
| 0xD4        | PCI resource allocation error. Out of Resources       |
| 0xD5        | No Space for Legacy Option ROM                        |
| 0xD6        | No Console Output Devices are found                   |
| 0xD7        | No Console Input Devices are found                    |
| 0xD8        | Invalid password                                      |
| 0xD9        | Error loading Boot Option (LoadImage returned error)  |
| 0xDA        | Boot Option is failed (StartImage returned error)     |
| 0xDB        | Flash update is failed                                |
| 0xDC        | Reset protocol is not available                       |

---



---

## 2.15 Serial ATA (SATA) / Serial ATAII (SATAII) Hard Disks Installation

This motherboard adopts Intel® Z68 chipset that supports Serial ATA (SATA) / Serial ATAII (SATAII) hard disks and RAID (RAID 0, RAID 1, RAID 10, RAID 5, Intel Rapid Storage and Intel Smart Response Technology) functions. You may install SATA / SATAII hard disks on this motherboard for internal storage devices. This section will guide you to install the SATA / SATAII hard disks.

- STEP 1: Install the SATA / SATAII hard disks into the drive bays of your chassis.
- STEP 2: Connect the SATA power cable to the SATA / SATAII hard disk.
- STEP 3: Connect one end of the SATA data cable to the motherboard's SATAII connector.
- STEP 4: Connect the other end of the SATA data cable to the SATA / SATAII hard disk.

## 2.16 Serial ATA3 (SATA3) Hard Disks Installation

This motherboard adopts Intel® Z68 chipset that supports Serial ATA3 (SATA3) hard disks and RAID (RAID 0, RAID 1, RAID 10, RAID 5, Intel Rapid Storage and Intel Smart Response Technology) functions for SATA3\_0 and SATA3\_1 connectors. It also adopts Marvell SE9120 chipset that supports Serial ATA3 (SATA3) hard disks for SATA3\_M1 and SATA3\_M2 connectors. You may install SATA3 hard disks on this motherboard for internal storage devices. This section will guide you to install the SATA3 hard disks.

- STEP 1: Install the SATA3 hard disks into the drive bays of your chassis.
- STEP 2: Connect the SATA power cable to the SATA3 hard disk.
- STEP 3: Connect one end of the SATA data cable to the motherboard's SATA3 connector.
- STEP 4: Connect the other end of the SATA data cable to the SATA3 hard disk.



Please be noted that SATA3\_M1 and SATA3\_M2 do not support RAID function. If you want to use RAID function on SATA3 connectors, please use SATA3\_0 and SATA3\_1 connectors.

---

## 2.17 Hot Plug and Hot Swap Functions for SATA / SATAII HDDs

This motherboard supports Hot Plug and Hot Swap functions for SATA / SATAII in RAID / AHCI mode. Intel® Z68 chipset provides hardware support for Advanced Host controller Interface (AHCI), a new programming interface for SATA host controllers developed thru a joint industry effort.



### NOTE

#### What is Hot Plug Function?

If the SATA / SATAII HDDs are NOT set for RAID configuration, it is called "Hot Plug" for the action to insert and remove the SATA / SATAII HDDs while the system is still power-on and in working condition.

However, please note that it cannot perform Hot Plug if the OS has been installed into the SATA / SATAII HDD.

#### What is Hot Swap Function?

If SATA / SATAII HDDs are built as RAID 1 or RAID 5 then it is called "Hot Swap" for the action to insert and remove the SATA / SATAII HDDs while the system is still power-on and in working condition.

## 2.18 Hot Plug and Hot Swap Functions for SATA3 HDDs

This motherboard supports Hot Plug and Hot Swap functions for SATA3 in RAID / AHCI mode. Intel® Z68 and Marvell SE9120 chipsets provide hardware support for Advanced Host controller Interface (AHCI), a new programming interface for SATA host controllers developed thru a joint industry effort.



### NOTE

#### What is Hot Plug Function?

If the SATA3 HDDs are NOT set for RAID configuration, it is called "Hot Plug" for the action to insert and remove the SATA3 HDDs while the system is still power-on and in working condition.

However, please note that it cannot perform Hot Plug if the OS has been installed into the SATA3 HDD.

#### What is Hot Swap Function?

If SATA3 HDDs are built as RAID 1 or RAID 5 then it is called "Hot Swap" for the action to insert and remove the SATA3 HDDs while the system is still power-on and in working condition.

---

## 2.19 SATA / SATAII / SATA3 HDD Hot Plug Feature and Operation Guide

This motherboard supports Hot Plug feature for SATA / SATAII / SATA3 HDD in RAID / AHCI mode. Please read below operation guide of Hot Plug feature carefully. Before you process the SATA / SATAII / SATA3 HDD Hot Plug, please check below cable accessories from the motherboard gift box pack.

A. 7-pin SATA data cable

B. SATA power cable with SATA 15-pin power connector interface

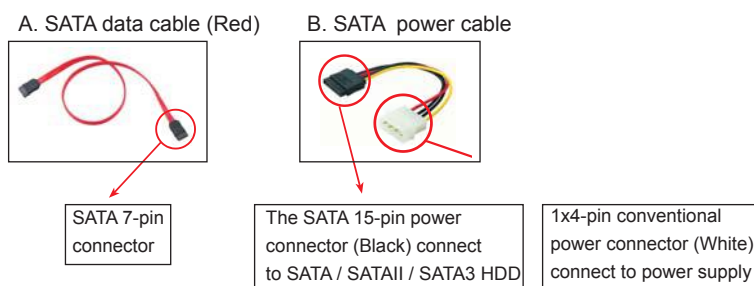

### Caution

1. Without SATA 15-pin power connector interface, the SATA / SATAII / SATA3 Hot Plug cannot be processed.
2. Even some SATA / SATAII / SATA3 HDDs provide both SATA 15-pin power connector and IDE 1x4-pin conventional power connector interfaces, the IDE 1x4-pin conventional power connector interface is definitely not able to support Hot Plug and will cause the HDD damage and data loss.

### Points of attention, before you process the Hot Plug:

1. Below operation procedure is designed only for our motherboard, which supports SATA / SATAII / SATA3 HDD Hot Plug.
    - \* The SATA / SATAII / SATA3 Hot Plug feature might not be supported by the chipset because of its limitation, the SATA / SATAII / SATA3 Hot Plug support information of our motherboard is indicated in the product spec on our website: [www.asrock.com](http://www.asrock.com)
  2. Make sure your SATA / SATAII / SATA3 HDD can support Hot Plug function from your dealer or HDD user manual. The SATA / SATAII / SATA3 HDD, which cannot support Hot Plug function, will be damaged under the Hot Plug operation.
  3. Please make sure the SATA / SATAII / SATA3 driver is installed into system properly. The latest SATA / SATAII / SATA3 driver is available on our support website: [www.asrock.com](http://www.asrock.com)
  4. Make sure to use the SATA power cable & data cable, which are from our motherboard package.
  5. Please follow below instructions step by step to reduce the risk of HDD crash or data loss.
-

---

## How to Hot Plug a SATA / SATAII / SATA3 HDD:

Points of attention, before you process the Hot Plug:

Please do follow below instruction sequence to process the Hot Plug, improper procedure will cause the SATA / SATAII / SATA3 HDD damage and data loss.

**Step 1** Please connect SATA power cable 1x4-pin end (White) to the power supply 1x4-pin cable.

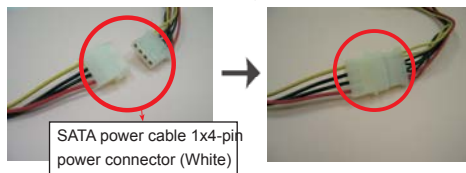

**Step 2** Connect SATA data cable to the motherboard's SATAII / SATA3 connector.



**Step 3** Connect SATA 15-pin power cable connector (Black) end to SATA / SATAII / SATA3 HDD.



**Step 4** Connect SATA data cable to the SATA / SATAII / SATA3 HDD.



## How to Hot Unplug a SATA / SATAII / SATA3 HDD:

Points of attention, before you process the Hot Unplug:

Please do follow below instruction sequence to process the Hot Unplug, improper procedure will cause the SATA / SATAII / SATA3 HDD damage and data loss.

**Step 1** Unplug SATA data cable from SATA / SATAII / SATA3 HDD side.

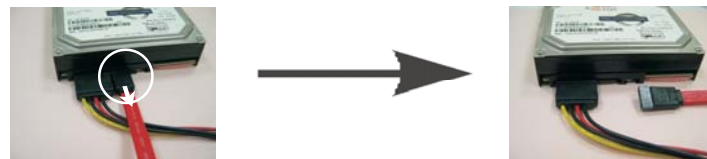

**Step 2** Unplug SATA 15-pin power cable connector (Black) from SATA / SATAII / SATA3 HDD side.

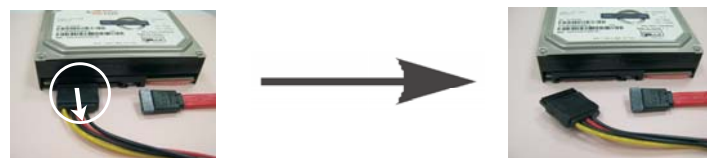

---

## 2.20 Driver Installation Guide

To install the drivers to your system, please insert the support CD to your optical drive first. Then, the drivers compatible to your system can be auto-detected and listed on the support CD driver page. Please follow the order from up to bottom side to install those required drivers. Therefore, the drivers you install can work properly.

## 2.21 Installing Windows® 7 / 7 64-bit / Vista™ / Vista™ 64-bit / XP / XP 64-bit With RAID Functions

If you want to install Windows® 7 / 7 64-bit / Vista™ / Vista™ 64-bit / XP / XP 64-bit OS on your SATA / SATAII / SATA3 HDDs with RAID functions, please follow below procedures according to the OS you install.

### 2.21.1 Installing Windows® XP / XP 64-bit With RAID Functions

If you want to install Windows® XP / XP 64-bit on your SATA / SATAII / SATA3 HDDs with RAID functions, please follow below steps.

#### **STEP 1: Set up UEFI.**

- A. Enter UEFI SETUP UTILITY → Advanced screen → SATA Configuration.
- B. Set the option "SATA Mode" to [RAID].

#### **STEP 2: Make a SATA / SATAII / SATA3 Driver Diskette.**

- A. Insert the Support CD into your optical drive to boot your system.
- B. During POST at the beginning of system boot-up, press <F11> key, and then a window for boot devices selection appears. Please select CD-ROM as the boot device.
- C. When you see the message on the screen, "Do you want to generate Serial ATA driver diskette [Y/N]?", press <Y>.
- D. Then you will see these messages,

**Please insert a diskette into the floppy drive.**

**WARNING! Formatting the floppy diskette will lose ALL data in it!**

**Start to format and copy files [Y/N]?**

Please insert a floppy diskette into the floppy drive, and press <Y>.

- E. The system will start to format the floppy diskette and copy SATA / SATAII / SATA3 drivers into the floppy diskette.

---

**STEP 3: Use “RAID Installation Guide” to set RAID configuration.**

Before you start to configure the RAID function, you need to check the installation guide in the Support CD for proper configuration. Please refer to the document in the Support CD, “Guide to SATA Hard Disks Installation and RAID Configuration”, which is located in the folder at the following path:

.. \ **RAID Installation Guide**

**STEP 4: Install Windows® XP / XP 64-bit OS on your system.**

After making a SATA / SATAII / SATA3 driver diskette and using “RAID Installation Guide” to set RAID configuration, you can start to install Windows® XP / XP 64-bit on your system. At the beginning of Windows setup, press F6 to install a third-party RAID driver. When prompted, insert the SATA / SATAII / SATA3 driver diskette containing the Intel® RAID driver. After reading the floppy disk, the driver will be presented. Select the driver to install according to the mode you choose and the OS you install.

After the installation of Windows® XP / XP-64bit OS, if you want to manage RAID functions, you are allowed to use both “RAID Installation Guide” and “Intel Rapid Storage Information” for RAID configuration. Please refer to the document in the Support CD, “Guide to SATA Hard Disks Installation and RAID Configuration”, which is located in the folder at the following path: .. \ **RAID Installation Guide** and the document in the support CD, “Guide to Intel Rapid Storage”, which is located in the folder at the following path:

.. \ **Intel Rapid Storage Information**



If you want to use “Intel Rapid Storage” in Windows® environment, install “SATAII driver” from the Support CD again so that “Intel Rapid Storage” will be installed to your system as well.

### 2.21.2 Setting Up a “RAID Ready” System

You can also set up a “RAID Ready” system with a single SATA / SATAII / SATA3 hard disk. A “RAID Ready” system can be seamlessly upgraded to RAID 0, RAID 1 or RAID 5 at a later date by using RAID migration feature of Intel Rapid Storage. The following steps outline how to build an Intel “RAID Ready” system.

1. Assemble the system and attach a single SATA / SATAII / SATA3 hard drive.
2. Set up system UEFI as step 1 of page 53. When done, exit Setup.
3. Make a SATA / SATAII / SATA3 driver diskette as step 2 of page 53. Begin Windows® setup by booting from the installation CD.
4. At the beginning of Windows® setup, press F6 to install a third-party RAID driver. When prompted, insert the SATA / SATAII / SATA3 driver diskette containing the Intel® RAID driver. After reading the floppy disk, the driver will be presented. Select the driver to install according to the mode you choose and the OS you install.

- 
5. Finish the Windows® installation and install all necessary drivers.
  6. Install the Intel(R) Rapid Storage software via the CD-ROM included with your motherboard or after downloading it from the Internet. This will add the Intel(R) Rapid Storage Console which can be used to manage the RAID configuration.
  7. After setting up a “RAID Ready” system as the above steps, you can follow the procedures of the next section to migrate the system to RAID 0, RAID 1 or RAID 5.

### 2.21.3 Migrating a “RAID Ready” System to RAID 0, RAID 1 or RAID 5

If you have an existing “RAID Ready” system, then you can use the following steps to perform a migration from a single non-RAID configuration to a two drive RAID 0, RAID 1 configuration or three drive RAID 5 configuration. To prepare for this, you will need another SATA / SATAII hard drive with a capacity equal to or greater than that currently being used as the source hard drive.

1. Physically attach one additional SATA / SATAII / SATA3 hard drive to the SATAII / SATA3 port not being used. Note the serial number of the hard drive already in the system; you will use this to select it as the source hard drive when initiating the migration.
2. Boot Windows®, install the Intel(R) Rapid Storage software, if not already installed, using the setup package obtained from a CD-ROM or from the Internet. This will install the necessary Intel Storage Utility and start menu links.
3. Open the Intel Storage Utility from the Start Menu and select “Create RAID volume from Existing Hard Drive” from the Actions menu. This will activate the Create RAID volume from Existing Hard Drive Wizard. Click through the dialogs as prompted. It’s important to understand what will occur during the migration process because any data on the destination hard drive will be lost.
4. Once the migration is complete, reboot the system. If you migrated to a RAID 0 volume, use Disk Management from within Windows® in order to partition and format the empty space created when the two hard drive capacities are combined. You may also use third-party software to extend any existing partitions within the RAID volume.

---

#### 2.21.4 Installing Windows® 7 / 7 64-bit / Vista™ / Vista™ 64-bit With RAID Functions

If you want to install Windows® 7 / 7 64-bit / Vista™ / Vista™ 64-bit on your SATA / SATAII / SATA3 HDDs with RAID functions, please follow below steps.

**STEP 1: Set up UEFI.**

- A. Enter UEFI SETUP UTILITY → Advanced screen → SATA Configuration.
- B. Set the option “SATA Mode” to [RAID].

**STEP 2: Use “RAID Installation Guide” to set RAID configuration.**

Before you start to configure the RAID function, you need to check the installation guide in the Support CD for proper configuration. Please refer to the document in the Support CD, “Guide to SATA Hard Disks Installation and RAID Configuration”, which is located in the folder at the following path:

.. \ **RAID Installation Guide**

**STEP 3: Install Windows® 7 / 7 64-bit / Vista™ / Vista™ 64-bit OS on your system.**

After the installation of Windows® 7 / 7 64-bit / Vista™ / Vista™ 64-bit OS, if you want to manage RAID functions, you are allowed to use both “RAID Installation Guide” and “Intel Rapid Storage Information” for RAID configuration. Please refer to the document in the Support CD, “Guide to SATA Hard Disks Installation and RAID Configuration”, which is located in the folder at the following path: .. \ **RAID Installation Guide** and the document in the support CD, “Guide to Intel Rapid Storage”, which is located in the folder at the following path: .. \ **Intel Rapid Storage Information**



If you want to use “Intel Rapid Storage” in Windows® environment, install “SATAII driver” from the Support CD again so that “Intel Rapid Storage” will be installed to your system as well.



---

## 2.22 Installing Windows® 7 / 7 64-bit / Vista™ / Vista™ 64-bit / XP / XP 64-bit Without RAID Functions

If you want to install Windows® 7 / 7 64-bit / Vista™ / Vista™ 64-bit / XP / XP 64-bit OS on your SATA / SATAII / SATA3 HDDs without RAID functions, please follow below procedures according to the OS you install.

### 2.22.1 Installing Windows® XP / XP 64-bit Without RAID Functions

If you want to install Windows® XP / XP 64-bit OS on your SATA / SATAII / SATA3 HDDs without RAID functions, please follow below steps.

#### Using SATA / SATAII / SATA3 HDDs with NCQ function

##### STEP 1: Set Up UEFI.

- A. Enter UEFI SETUP UTILITY → Advanced screen → SATA Configuration.
- B. Set the option "SATA Mode" to [AHCI]. (For SATA3\_0, SATA3\_1 and SATA2\_2 to SATA2\_5 ports.)  
Set the option "Marvell SATA3 Operation Mode" to [AHCI]. (For SATA3\_M1 and SATA3\_M2 ports.)

##### STEP 2: Make a SATA / SATAII / SATA3 driver diskette.

Please make a SATA / SATAII / SATA3 driver diskette by following section 2.21.1 step 2 on page 53.

##### STEP 3: Install Windows® XP / XP 64-bit OS on your system.

After making a SATA / SATAII / SATA3 driver diskette, you can start to install Windows® XP / XP 64-bit on your system. At the beginning of Windows® setup, press F6 to install a third-party AHCI driver. When prompted, insert the SATA / SATAII / SATA3 driver diskette containing the Intel® AHCI driver. After reading the floppy disk, the driver will be presented. Select the driver to install according to the mode you choose and the OS you install.

#### Using SATA / SATAII / SATA3 HDDs without NCQ function

##### STEP 1: Set Up UEFI.

- A. Enter UEFI SETUP UTILITY → Advanced screen → SATA Configuration.
- B. Set the option "SATA Mode" to [IDE]. (For SATA3\_0, SATA3\_1 and SATA2\_2 to SATA2\_5 ports.)  
Set the option "Marvell SATA3 Operation Mode" to [IDE]. (For SATA3\_M1 and SATA3\_M2 ports.)

##### STEP 2: Install Windows® XP / XP 64-bit OS on your system.

---

## 2.22.2 Installing Windows® 7 / 7 64-bit / Vista™ / Vista™ 64-bit Without RAID Functions

If you want to install Windows® 7 / 7 64-bit / Vista™ / Vista™ 64-bit OS on your SATA / SATAII / SATA3 HDDs without RAID functions, please follow below steps.

### Using SATA / SATAII / SATA3 HDDs with NCQ function

#### STEP 1: Set Up UEFI.

- A. Enter UEFI SETUP UTILITY → Advanced screen → SATA Configuration.
- B. Set the option "SATA Mode" to [AHCI]. (For SATA3\_0, SATA3\_1 and SATA2\_2 to SATA2\_5 ports.)  
Set the option "Marvell SATA3 Operation Mode" to [AHCI]. (For SATA3\_M1 and SATA3\_M2 ports.)

#### STEP 2: Install Windows® 7 / 7 64-bit / Vista™ / Vista™ 64-bit OS on your system.

### Using SATA / SATAII / SATA3 HDDs without NCQ function

#### STEP 1: Set Up UEFI.

- A. Enter UEFI SETUP UTILITY → Advanced screen → SATA Configuration.
- B. Set the option "SATA Mode" to [IDE]. (For SATA3\_0, SATA3\_1 and SATA2\_2 to SATA2\_5 ports.)  
Set the option "Marvell SATA3 Operation Mode" to [IDE]. (For SATA3\_M1 and SATA3\_M2 ports.)

#### STEP 2: Install Windows® 7 / 7 64-bit / Vista™ / Vista™ 64-bit OS on your system.

---

## Chapter 3: UEFI SETUP UTILITY

### 3.1 Introduction

This section explains how to use the UEFI SETUP UTILITY to configure your system. The UEFI chip on the motherboard stores the UEFI SETUP UTILITY. You may run the UEFI SETUP UTILITY when you start up the computer. Please press <F2> or <Del> during the Power-On-Self-Test (POST) to enter the UEFI SETUP UTILITY, otherwise, POST will continue with its test routines.

If you wish to enter the UEFI SETUP UTILITY after POST, restart the system by pressing <Ctl> + <Alt> + <Delete>, or by pressing the reset button on the system chassis. You may also restart by turning the system off and then back on.



Because the UEFI software is constantly being updated, the following UEFI setup screens and descriptions are for reference purpose only, and they may not exactly match what you see on your screen.

#### 3.1.1 UEFI Menu Bar

The top of the screen has a menu bar with the following selections:

|                    |   |
|--------------------|---|
| <b>Main</b>        | To set up the system time/date information                                  |
| <b>OC Tweaker</b>  | To set up overclocking features   |
| <b>Advanced</b>    | To set up the advanced UEFI features  |
| <b>H/W Monitor</b> | To display current hardware status  |
| <b>Boot</b>        | To set up the default system device to locate and load the Operating System |
| <b>Security</b>    | To set up the security features   |
| <b>Exit</b>        | To exit the current screen or the UEFI SETUP UTILITY                        |

Use <←> key or <→> key to choose among the selections on the menu bar, and then press <Enter> to get into the sub screen. You can also use the mouse to click your required item.

---

### 3.1.2 Navigation Keys

Please check the following table for the function description of each navigation key.

| Navigation Key(s) | Function Description                                  |
|-------------------|---|
| ← / →             | Moves cursor left or right to select Screens          |
| ↑ / ↓             | Moves cursor up or down to select items               |
| + / -             | To change option for the selected items               |
| <Enter>           | To bring up the selected screen                       |
| <F1>              | To display the General Help Screen                    |
| <F9>              | To load optimal default values for all the settings   |
| <F10>             | To save changes and exit the UEFI SETUP UTILITY       |
| <ESC>             | To jump to the Exit Screen or exit the current screen |

### 3.2 Main Screen

When you enter the UEFI SETUP UTILITY, the Main screen will appear and display the system overview.



---

### 3.3 OC Tweaker Screen

In the OC Tweaker screen, you can set up overclocking features.



#### Advanced Turbo 50

You can use this option to increase your system performance. This option appears only when your CPU supports this function.

#### Load Optimized CPU OC Setting

You can use this option to load optimized CPU overclocking setting. Please note that overclocking may cause damage to your CPU and motherboard. It should be done at your own risk and expense.

#### Load GPU EZ OC Setting

You can use this option to load GPU EZ overclocking setting. Please note that overclocking may cause damage to your GPU and motherboard. It should be done at your own risk and expense.

#### CPU Control

##### CPU Ratio Setting

Use this item to change the ratio value of this motherboard.

##### GT Over Clock

Use this to enable or disable GT Over Clock by Internal Graphics Device. The default value is [Disabled].

##### Intel SpeedStep Technology

Intel SpeedStep technology is Intel's new power saving technology. Processor can switch between multiple frequency and voltage points to enable power savings. The default value is [Enabled]. Configuration options: [Auto], [Enabled] and [Disabled]. If you install Windows® XP and select [Auto], you need to set the "Power Schemes" as "Portable/Laptop" to enable this function. If you install Windows® Vista™ / 7 and want to enable this function, please set this item to [Enabled]. This item will be hidden if the current CPU does not support Intel SpeedStep technology.



Please note that enabling this function may reduce CPU voltage and lead to system stability or compatibility issue with some power supplies. Please set this item to [Disable] if above issue occurs.

### Intel Turbo Boost Technology

Use this item to enable or disable Intel Turbo Boost Technology. Turbo Boost allows processor cores to run faster than marked frequency in specific condition. The default value is [Enabled].

### Turbo Boost Power Limit

Use this item to adjust Turbo Boost power limit. Configuration options: [Auto] and [Manual]. The default value is [Auto].

### Additional Turbo Voltage

Use this item to add voltage when CPU is in Turbo mode.

### Core Current Limit

Use this item to add voltage when CPU is in Turbo mode.

### Host Clock Override (BCLK)

Use this to adjust the host clock (BCLK) frequency. Min: 95MHz, Max: 110MHz.

### Spread Spectrum

This item should always be [Auto] for better system stability.

## DRAM Timing Control

### DRAM Configuration



### Load XMP Setting

Use this to load XMP setting. Configuration options: [Auto], [Profile 1] and [Profile 2]. The default value is [Auto].

### DRAM Frequency

If [Auto] is selected, the motherboard will detect the memory module(s) inserted and assigns appropriate frequency automatically.

---

**CAS# Latency (tCL)**

Use this item to change CAS# Latency (tCL) Auto/Manual setting. The default is [Auto].

**RAS# to CAS# Delay (tRCD)**

Use this item to change RAS# to CAS# Delay (tRCD) Auto/Manual setting. The default is [Auto].

**Row Precharge Time (tRP)**

Use this item to change Row Precharge Time (tRP) Auto/Manual setting. The default is [Auto].

**RAS# Active Time (tRAS)**

Use this item to change RAS# Active Time (tRAS) Auto/Manual setting. The default is [Auto].

**Command Rate (CR)**

Use this item to change Command Rate (CR) Auto/Manual setting. Min: 1N. Max: 2N. The default is [Auto].

**Write Recovery Time (tWR)**

Use this item to change Write Recovery Time (tWR) Auto/Manual setting. The default is [Auto].

**Refresh Cycle Time (tRFC)**

Use this item to change Refresh Cycle Time (tRFC) Auto/Manual setting. The default is [Auto].

**RAS to RAS Delay (tRRD)**

Use this item to change RAS to RAS Delay (tRRD) Auto/Manual setting. The default is [Auto].

**Write to Read Delay (tWTR)**

Use this item to change Write to Read Delay (tWTR) Auto/Manual setting. The default is [Auto].

**Read to Precharge (tRTP)**

Use this item to change Read to Precharge (tRTP) Auto/Manual setting. The default is [Auto].

**Four Activate Window (tFAW)**

Use this item to change Four Activate Window (tFAW) Auto/Manual setting. The default is [Auto].

**Memory Fast Boot**

Use this item to adjust DDR fast boot mode. The default value is [Auto].

**Memory Power Down Mode**

Use this item to adjust DDR power down mode. Configuration options: [Auto], [Slow] and [Fast]. The default value is [Auto].

**ODT WR (CHA)**

Use this item to change ODT WR (CHA) Auto/Manual setting. The default is [Auto].

---

**ODT NOM (CHA)**

Use this item to change ODT NOM (CHA) Auto/Manual setting. The default is [Auto].

**ODT WR (CHB)**

Use this item to change ODT WR (CHB) Auto/Manual setting. The default is [Auto].

**ODT NOM (CHB)**

Use this item to change ODT NOM (CHB) Auto/Manual setting. The default is [Auto].

**Voltage Control****Power Saving Mode**

Use this to enable or disable Power Saving Mode. The default value is [Disabled].

**CPU Core Voltage**

Use this to select CPU Core Voltage. The default value is [Auto].

**CPU Load-Line Calibration**

CPU Load-Line Calibration helps prevent CPU voltage droop when the system is under heavy load.

**IGPU Voltage**

Use this to select IGPU Voltage. The default value is [Auto].

**IGPU VDROOP**

Use this to select IGPU VDROOP. The default value is [Auto].

**DRAM Voltage**

Use this to select DRAM Voltage. The default value is [Auto].

**PCH Voltage**

Use this to select PCH Voltage. The default value is [Auto].

**CPU PLL Voltage**

Use this to select CPU PLL Voltage. The default value is [Auto].

**VTT Voltage**

Use this to select VTT Voltage. The default value is [Auto].

**VCCSA Voltage**

Use this to select VCCSA Voltage. The default value is [Auto].

**User Default**

In this option, you are allowed to load and save three user defaults according to your own requirements.



---

### 3.4 Advanced Screen

In this section, you may set the configurations for the following items: CPU Configuration, North Bridge Configuration, South Bridge Configuration, Storage Configuration, Super IO Configuration, ACPI Configuration and USB Configuration.



Setting wrong values in this section may cause the system to malfunction.

#### ASRock Instant Flash

ASRock Instant Flash is a UEFI flash utility embedded in Flash ROM. This convenient UEFI update tool allows you to update system UEFI without entering operating systems first like MS-DOS or Windows®. Just launch this tool and save the new UEFI file to your USB flash drive, floppy disk or hard drive, then you can update your UEFI only in a few clicks without preparing an additional floppy diskette or other complicated flash utility. Please be noted that the USB flash drive or hard drive must use FAT32/16/12 file system. If you execute ASRock Instant Flash utility, the utility will show the UEFI files and their respective information. Select the proper UEFI file to update your UEFI, and reboot your system after UEFI update process completes.

---

### 3.4.1 CPU Configuration



#### Intel Hyper Threading Technology

To enable this feature, it requires a computer system with an Intel processor that supports Hyper-Threading technology and an operating system that includes optimization for this technology, such as Microsoft® Windows® XP / Vista™ / 7. Set to [Enabled] if using Microsoft® Windows® XP, Vista™, 7, or Linux kernel version 2.4.18 or higher. This option will be hidden if the installed CPU does not support Hyper-Threading technology.

#### Active Processor Cores

Use this item to select the number of cores to enable in each processor package. Configuration options: [All], [1] and [2]. The default value is [All].

#### Hardware Prefetcher

Use this item to turn on/off the MLC streamer prefetcher.

#### Adjacent Cache Line Prefetch

Use this item to turn on/off prefetching of adjacent cache lines.

#### Enhance Halt State (C1E)

All processors support the Halt State (C1). The C1 state is supported through the native processor instructions HLT and MWAIT and requires no hardware support from the chipset. In the C1 power state, the processor maintains the context of the system caches.

#### CPU C3 State Support

Use this to enable or disable CPU C3 (ACPI C2) report to OS.

#### CPU C6 State Support

Use this to enable or disable CPU C6 (ACPI C3) report to OS.

#### Package C State Support

Selected option will program into C State package limit register. The default value is [Auto].

---

**CPU Thermal Throttling**

You may select [Enabled] to enable CPU internal thermal control mechanism to keep the CPU from overheated.

**Intel Virtualization Technology**

When this option is set to [Enabled], a VMM (Virtual Machine Architecture) can utilize the additional hardware capabilities provided by Vanderpool Technology. This option will be hidden if the installed CPU does not support Intel Virtualization Technology.

**No-Excute Memory Protection**

No-Execution (NX) Memory Protection Technology is an enhancement to the IA-32 Intel Architecture. An IA-32 processor with "No Execute (NX) Memory Protection" can prevent data pages from being used by malicious software to execute code. This option will be hidden if the current CPU does not support No-Excute Memory Protection.

**Local x2APIC**

Use this to enable or disable Local x2APIC. The default value is [Disabled]. Please be noted that some OS do not support this function.

---

### 3.4.2 North Bridge Configuration



#### **Low MMIO Align**

Low MMIO resources align at 64MB/1024MB. The default value is [64MB].

#### **VT-d**

Use this to enable or disable Intel® VT-d technology (Intel® Virtualization Technology for Directed I/O). The default value of this feature is [Disabled].

#### **Primary Graphics Adapter**

This allows you to select [Onboard], [PCI] or [PCI Express] as the boot graphic adapter priority. The default value is [PCI Express].

#### **Onboard VGA Share Memory**

This allows you to set onboard VGA share memory feature. The default value is [Auto]. Configuration options: [Auto], [32MB], [64MB], [128MB], [256MB] and [512MB].

#### **Render Standby**

Use this to enable or disable Render Standby by Internal Graphics Device. The default value is [Enabled].

#### **IGD Multi-Monitor**

Use this to enable or disable IGD Multi-Monitor by Internal Graphics Device. The default value is [Disabled].

#### **DVMT Mode Select**

Use this option to adjust DVMT mode. The default value is [DVMT Mode]. DVMT (Dynamic Video Memory Technology) is an architecture that offers breakthrough performance for the motherboard through efficient memory utilization. In DVMT mode, the graphics driver allocates memory as needed for running graphics applications and is cooperatively using this memory with other system components. This item will not be used under Windows® Vista™ / 7 OS because the driver will intelligently detect physical memory available and allocate necessary video memory.

---

**DVMT Memory**

You are allowed to adjust the shared memory size in this item. Configuration options: [128MB], [256MB] and [Maximum]. The option [Maximum] only appears when you adopt the memory module with 1024MB or above.

---

### 3.4.3 South Bridge Configuration



#### Restore on AC/Power Loss

This allows you to set the power state after an unexpected AC/power loss. If [Power Off] is selected, the AC/power remains off when the power recovers. If [Power On] is selected, the AC/power resumes and the system starts to boot up when the power recovers.

#### Deep Sx

Mobile platforms support Deep S4/S5 in DC only and desktop platforms support Deep S4/S5 in AC only. Configuration options: [Disabled], [Enabled in S5] and [S4 and S5]. The default value is [Disabled].

#### Onboard LAN

This allows you to enable or disable the “Onboard LAN” feature.

#### Onboard 1394

This allows you to enable or disable the “Onboard 1394” feature.

#### Onboard HD Audio

Select [Auto], [Enabled] or [Disabled] for the onboard HD Audio feature. If you select [Auto], the onboard HD Audio will be disabled when PCI Sound Card is plugged.

#### Front Panel

Select [Auto] or [Disabled] for the onboard HD Audio Front Panel.

#### On/Off Play

Use this item to enable or disable On/Off Play Technology. The default value is [Enabled]. When On/Off Play is enabled, Deep Sx will be disabled. If you want to enable Deep Sx, please disable On/Off Play first.

#### Onboard HDMI HD Audio

This allows you to enable or disable the “Onboard HDMI HD Audio” feature.

### ACPI HPET Table

Use this item to enable or disable ACPI HPET Table. The default value is [Enabled]. Please set this option to [Enabled] if you plan to use this motherboard to submit Windows® Vista™ certification.

## 3.4.4 Storage Configuration



### Marvell SATA3 Operation Mode

This item is for SATA3\_M1 and SATA3\_M2 ports. Use this to select Marvell SATA3 operation mode. Configuration options: [IDE Mode], [AHCI Mode] and [Disabled]. The default value is [IDE Mode].

### Marvell SATA3 Bootable

Use this to enable or disable Onboard Marvell SATA3 Option ROM. If Option ROM is disabled, UEFI cannot use the SATA device to connect to Marvell SATA3 controller as Boot Device.



We recommend to use Intel® Z68 SATA ports (SATA3\_0, SATA3\_1, SATA2\_2, SATA2\_3, SATA2\_4 and SATA2\_5) for your bootable devices. This will minimum your boot time and get the best performance. But if you still want to boot from Marvell SATA3 controller, you can still enable this in UEFI.

### SATA Mode

This item is for SATA3\_0, SATA3\_1 and SATA2\_2 to SATA2\_5 ports. Use this to select SATA mode. Configuration options: [IDE Mode], [AHCI Mode], [RAID Mode] and [Disabled]. The default value is [IDE Mode].



AHCI (Advanced Host Controller Interface) supports NCQ and other new features that will improve SATA disk performance but IDE mode does not have these advantages.

---

### Hard Disk S.M.A.R.T.

Use this item to enable or disable the S.M.A.R.T. (Self-Monitoring, Analysis, and Reporting Technology) feature. Configuration options: [Disabled], [Auto], [Enabled].

### 3.4.5 Super IO Configuration



#### OnBoard Floppy Controller

Use this item to enable or disable floppy drive controller.

#### Serial Port

Use this item to enable or disable the onboard serial port.

#### Serial Port Address

Use this item to set the address for the onboard serial port. Configuration options: [3F8 / IRQ4] and [3E8 / IRQ4].

#### Infrared Port

Use this item to enable or disable the onboard infrared port.

#### Infrared Port Address

Use this item to set the address for the onboard infrared port. Configuration options: [2F8 / IRQ3] and [2E8 / IRQ3].

#### CIR Controller

Use this item to enable or disable CIR controller.



---

### 3.4.6 ACPI Configuration



#### **Suspend to RAM**

Use this item to select whether to auto-detect or disable the Suspend-to-RAM feature. Select [Auto] will enable this feature if the OS supports it.

#### **Check Ready Bit**

Use this item to enable or disable the feature Check Ready Bit.

#### **PS/2 Keyboard Power On**

Use this item to enable or disable PS/2 keyboard to turn on the system from the power-soft-off mode.

#### **PCI Devices Power On**

Use this item to enable or disable PCI devices to turn on the system from the power-soft-off mode.

#### **Ring-In Power On**

Use this item to enable or disable Ring-In signals to turn on the system from the power-soft-off mode.

#### **CIR Power On**

Use this item to enable or disable CIR to power on the system.

#### **RTC Alarm Power On**

Use this item to enable or disable RTC (Real Time Clock) to power on the system.

---

### 3.4.7 USB Configuration



#### **USB 2.0 Controller**

Use this item to enable or disable the use of USB 2.0 controller.

#### **USB 3.0 Controller**

Use this item to enable or disable the use of USB 3.0 controller.

#### **Legacy USB Support**

Use this option to select legacy support for USB devices. There are four configuration options: [Enabled], [Auto], [Disabled] and [UEFI Setup Only]. The default value is [Enabled]. Please refer to below descriptions for the details of these four options:

[Enabled] - Enables support for legacy USB.

[Auto] - Enables legacy support if USB devices are connected.

[Disabled] - USB devices are not allowed to use under legacy OS and UEFI setup when [Disabled] is selected. If you have USB compatibility issue, it is recommended to select [Disabled] to enter OS.

[UEFI Setup Only] - USB devices are allowed to use only under UEFI setup and Windows / Linux OS.

#### **Legacy USB 3.0 Support**

Use this option to enable or disable legacy support for USB 3.0 devices.

The default value is [Enabled].

---

### 3.5 Hardware Health Event Monitoring Screen

In this section, it allows you to monitor the status of the hardware on your system, including the parameters of the CPU temperature, motherboard temperature, CPU fan speed, chassis fan speed, and the critical voltage.



#### CPU Fan 1 & 2 Setting

This allows you to set the CPU fan 1 & 2 speed. Configuration options: [Full On] and [Automatic Mode]. The default is value [Full On].

#### Chassis Fan 1 Setting

This allows you to set the chassis fan 1 speed. Configuration options: [Full On], [Automatic Mode] and [Manual Mode]. The default is value [Full On].

#### Chassis Fan 2 Setting

This allows you to set the chassis fan 2 speed. Configuration options: [Level 1] to [Level 4]. The default is value [Level 4].

#### Chassis Fan 3 Setting

This allows you to set the chassis fan 3 speed. Configuration options: [Full On] and [Manual Mode]. The default is value [Full On].

#### Over Temperature Protection

Use this to enable or disable Over Temperature Protection. The default value is [Enabled].

---

### 3.6 Boot Screen

In this section, it will display the available devices on your system for you to configure the boot settings and the boot priority.



#### Setup Prompt Timeout

This shows the number of seconds to wait for setup activation key. 65535(0xFFFF) means indefinite waiting.

#### Bootup Num-Lock

If this item is set to [On], it will automatically activate the Numeric Lock function after boot-up.

#### Full Screen Logo

Use this item to enable or disable OEM Logo. The default value is [Enabled].

#### AddOn ROM Display

Use this option to adjust AddOn ROM Display. If you enable the option "Full Screen Logo" but you want to see the AddOn ROM information when the system boots, please select [Enabled]. Configuration options: [Enabled] and [Disabled]. The default value is [Enabled].

#### Boot From Onboard LAN

Use this item to enable or disable the Boot From Onboard LAN feature.

#### Boot Failure Guard

Enable or disable the feature of Boot Failure Guard.

#### Boot Failure Guard Count

Enable or disable the feature of Boot Failure Guard Count.

---

### 3.7 Security Screen

In this section, you may set or change the supervisor/user password for the system. For the user password, you may also clear it.



---

### 3.8 Exit Screen



#### **Save Changes and Exit**

When you select this option, it will pop-out the following message, “Save configuration changes and exit setup?” Select [OK] to save the changes and exit the UEFI SETUP UTILITY.

#### **Discard Changes and Exit**

When you select this option, it will pop-out the following message, “Discard changes and exit setup?” Select [OK] to exit the UEFI SETUP UTILITY without saving any changes.

#### **Discard Changes**

When you select this option, it will pop-out the following message, “Discard changes?” Select [OK] to discard all changes.

#### **Load UEFI Defaults**

Load UEFI default values for all the setup questions. F9 key can be used for this operation.

#### **Launch EFI Shell from filesystem device**

Attempts to Launch EFI Shell application (Shell64.efi) from one of the available filesystem devices.

---

## Chapter 4: Software Support

### 4.1 Install Operating System

This motherboard supports various Microsoft® Windows® operating systems: 7 / 7 64-bit / Vista™ / Vista™ 64-bit / XP / XP 64-bit. Because motherboard settings and hardware options vary, use the setup procedures in this chapter for general reference only. Refer to your OS documentation for more information.

### 4.2 Support CD Information

The Support CD that came with the motherboard contains necessary drivers and useful utilities that enhance the motherboard features.

#### 4.2.1 Running The Support CD

To begin using the support CD, insert the CD into your CD-ROM drive. The CD automatically displays the Main Menu if "AUTORUN" is enabled in your computer. If the Main Menu did not appear automatically, locate and double click on the file "ASSETUP.EXE" from the BIN folder in the Support CD to display the menus.

#### 4.2.2 Drivers Menu

The Drivers Menu shows the available devices drivers if the system detects installed devices. Please install the necessary drivers to activate the devices.

#### 4.2.3 Utilities Menu

The Utilities Menu shows the applications software that the motherboard supports. Click on a specific item then follow the installation wizard to install it.

#### 4.2.4 Contact Information

If you need to contact ASRock or want to know more about ASRock, welcome to visit ASRock's website at <http://www.asrock.com>; or you may contact your dealer for further information.

---

## **Installing OS on a HDD Larger Than 2TB**

This motherboard is adopting UEFI BIOS that allows Windows® OS to be installed on a large size HDD (>2TB). Please follow below procedure to install the operating system.

1. Please make sure to use **Windows® Vista™ 64-bit (with SP1 or above)** or **Windows® 7 64-bit**.
2. Press <F2> or <Delete> at system POST. Set **AHCI Mode** in UEFI Setup Utility > Advanced > Storage Configuration > SATA Mode.
3. Choose the item “**UEFI:xxx**” to boot in UEFI Setup Utility > Boot > Boot Option #1. (“xxx” is the device which contains your Windows® installation files. Normally it is an optical drive.) You can also press <F11> to launch boot menu at system POST and choose the item “**UEFI:xxx**” to boot.
4. Start Windows® installation.
5. If you install **Windows® 7 64-bit** OS, OS will be formatted by GPT (GUID Partition Table). Please install the hot fix from Microsoft®:  
<http://support.microsoft.com/kb/979903>



---

## Note

1. For Windows® XP / XP 64-bit / Vista™ / Vista™ 64-bit users, if you plan to install the PCI Express graphics card for video output, please set the UEFI option "IGD Multi-Monitor" to [Disabled] to disable the onboard VGA in advance.
2. Intel® will update the new version Rapid Storage Technology driver in the near future. For the new version Rapid Storage Technology driver, please check our website for the latest information: <http://www.asrock.com>
3. If you want to use NVIDIA® SLI™ Technology, please make sure that your graphics card driver version is 270.61 and later.
4. We provide Cyberlink MediaEspresso 6.5 Trial, which is located in the following path of our support CD: ..\Utilities\MediaEspresso\CyberLink\Win7-64\_Win7\_Vista64\_Vista\_XP64\_XP(v6.5)\setup.exe

CyberLink MediaEspresso 6.5 trial now supports Intel® Quick Sync Video hardware transcoding and is optimized for second generation Core i7, i5, and i3 processors to accelerated conversion of all your favorite media files for your favorite portable players. Now you can easily display your favorite movies, songs and photos on iPhone, iPas, PSP, Xbox, Youtube, Facebook etc. Compile, convert and enjoy images and songs as much as your want and enhance your videos to new levels with TrueTheater Technology. Try it today.

Limitations:

- \* 30-day trial limitation
- \* Convert videos to the H.264 format 50 times