

The background of the cover features a complex arrangement of interlocking gears in various sizes, rendered in shades of gray. A large, prominent gear is positioned in the upper left quadrant. The lower half of the image is dominated by a large, circular brushed metal texture that resembles a CD or DVD surface, with concentric lines radiating from the center. The overall aesthetic is industrial and technical.

**ASRock**

# Z390 Taichi Ultimate

User Manual

Version 1.0

Published July 2018

Copyright©2018 ASRock INC. All rights reserved.

### Copyright Notice:

No part of this documentation may be reproduced, transcribed, transmitted, or translated in any language, in any form or by any means, except duplication of documentation by the purchaser for backup purpose, without written consent of ASRock Inc.

Products and corporate names appearing in this documentation may or may not be registered trademarks or copyrights of their respective companies, and are used only for identification or explanation and to the owners' benefit, without intent to infringe.

### Disclaimer:

Specifications and information contained in this documentation are furnished for informational use only and subject to change without notice, and should not be construed as a commitment by ASRock. ASRock assumes no responsibility for any errors or omissions that may appear in this documentation.

With respect to the contents of this documentation, ASRock does not provide warranty of any kind, either expressed or implied, including but not limited to the implied warranties or conditions of merchantability or fitness for a particular purpose.

In no event shall ASRock, its directors, officers, employees, or agents be liable for any indirect, special, incidental, or consequential damages (including damages for loss of profits, loss of business, loss of data, interruption of business and the like), even if ASRock has been advised of the possibility of such damages arising from any defect or error in the documentation or product.



This device complies with Part 15 of the FCC Rules. Operation is subject to the following two conditions:

- (1) this device may not cause harmful interference, and
- (2) this device must accept any interference received, including interference that may cause undesired operation.

### CALIFORNIA, USA ONLY

The Lithium battery adopted on this motherboard contains Perchlorate, a toxic substance controlled in Perchlorate Best Management Practices (BMP) regulations passed by the California Legislature. When you discard the Lithium battery in California, USA, please follow the related regulations in advance.

“Perchlorate Material-special handling may apply, see [www.dtsc.ca.gov/hazardouswaste/perchlorate](http://www.dtsc.ca.gov/hazardouswaste/perchlorate)”

**ASRock Website:** <http://www.asrock.com>

## AUSTRALIA ONLY

Our goods come with guarantees that cannot be excluded under the Australian Consumer Law. You are entitled to a replacement or refund for a major failure and compensation for any other reasonably foreseeable loss or damage caused by our goods. You are also entitled to have the goods repaired or replaced if the goods fail to be of acceptable quality and the failure does not amount to a major failure. If you require assistance please call ASRock Tel : +886-2-28965588 ext.123 (Standard International call charges apply)

The terms HDMI® and HDMI High-Definition Multimedia Interface, and the HDMI logo are trademarks or registered trademarks of HDMI Licensing LLC in the United States and other countries.



Manufactured under license under U.S. Patent Nos: 5,956,674; 5,974,380; 6,487,535; 7,003,467 & other U.S. and worldwide patents issued & pending. DTS, the Symbol, & DTS and the Symbol together is a registered trademark & DTS Connect, DTS Interactive, DTS Neo:PC are trademarks of DTS, Inc. Product includes software.

© DTS, Inc., All Rights Reserved.



## CE Warning

This device complies with directive 2014/53/EU issued by the Commission of the European Community.

This equipment complies with EU radiation exposure limits set forth for an uncontrolled environment.

This equipment should be installed and operated with minimum distance 20cm between the radiator & your body.

Operations in the 5.15-5.35GHz band are restricted to indoor usage only.

	AT	BE	BG	CH	CY	CZ	DE
	DK	EE	EL	ES	FI	FR	HR
	HU	IE	IS	IT	LI	LT	LU
	LV	MT	NL	NO	PL	PT	RO
	SE	SI	SK	TR	UK		



Radio transmit power per transceiver type

Function	Frequency	Maximum Output Power (EIRP)
WiFi	2400-2483.5 MHz	18.5 + / -1.5 dbm
	5150-5250 MHz	21.5 + / -1.5 dbm
	5250-5350 MHz	18.5 + / -1.5 dbm (no TPC) 21.5 + / -1.5 dbm (TPC)
	5470-5725 MHz	25.5 + / -1.5 dbm (no TPC) 28.5 + / -1.5 dbm (TPC)
Bluetooth	2400-2483.5 MHz	8.5 + / -1.5 dbm

# Contents

<b>Chapter 1 Introduction</b>	<b>1</b>
1.1 Package Contents	1
1.2 Specifications	2
1.3 Motherboard Layout	8
1.4 I/O Panel	10
1.5 WiFi-802.11ac Module and ASRock WiFi 2.4/5 GHz Antenna	12
<b>Chapter 2 Installation</b>	<b>13</b>
2.1 Installing the CPU	14
2.2 Installing the CPU Fan and Heatsink	17
2.3 Installing Memory Modules (DIMM)	18
2.4 Expansion Slots (PCI Express Slots)	20
2.5 Jumpers Setup	21
2.6 Onboard Headers and Connectors	22
2.7 Smart Switches	28
2.8 Dr. Debug	29
2.9 SLI™ and Quad SLI™ Operation Guide	31
2.9.1 Installing Two SLI™-Ready Graphics Cards	31
2.9.2 Driver Installation and Setup	33
2.10 CrossFireX™, 3-Way CrossFireX™ and Quad CrossFireX™ Operation Guide	34
2.10.1 Installing Two CrossFireX™-Ready Graphics Cards	34
2.10.2 Installing Three CrossFireX™-Ready Graphics Cards	36

2.10.3	Driver Installation and Setup	37
2.11	M.2_SSD (NGFF) Module Installation Guide (M2_1 and M2_2)	38
2.12	M.2_SSD (NGFF) Module Installation Guide (M2_3)	40
<b>Chapter 3 Software and Utilities Operation</b>		<b>44</b>
3.1	Installing Drivers	44
3.2	A-Tuning	45
3.3	ASRock Live Update & APP Shop	48
3.3.1	UI Overview	48
3.3.2	Apps	49
3.3.3	BIOS & Drivers	52
3.3.4	Setting	53
3.4	ASRock Polychrome RGB	54
<b>Chapter 4 UEFI SETUP UTILITY</b>		<b>55</b>
4.1	Introduction	57
4.2	EZ Mode	58
4.3	Advanced Mode	59
4.3.1	UEFI Menu Bar	59
4.3.2	Navigation Keys	60
4.4	Main Screen	61
4.5	OC Tweaker Screen	62
4.6	Advanced Screen	75
4.6.1	CPU Configuration	76
4.6.2	Chipset Configuration	78
4.6.3	Storage Configuration	81

4.6.4	Intel® Thunderbolt	83
4.6.5	Super IO Configuration	85
4.6.6	ACPI Configuration	86
4.6.7	USB Configuration	87
4.6.8	Trusted Computing	88
4.7	Tools	89
4.8	Hardware Health Event Monitoring Screen	91
4.9	Security Screen	96
4.10	Boot Screen	97
4.11	Exit Screen	100

# Chapter 1 Introduction

Thank you for purchasing ASRock Z390 Taichi Ultimate motherboard, a reliable motherboard produced under ASRock's consistently stringent quality control. It delivers excellent performance with robust design conforming to ASRock's commitment to quality and endurance.

In this documentation, Chapter 1 and 2 contains the introduction of the motherboard and step-by-step installation guides. Chapter 3 contains the operation guide of the software and utilities. Chapter 4 contains the configuration guide of the BIOS setup.



*Because the motherboard specifications and the BIOS software might be updated, the content of this documentation will be subject to change without notice. In case any modifications of this documentation occur, the updated version will be available on ASRock's website without further notice. If you require technical support related to this motherboard, please visit our website for specific information about the model you are using. You may find the latest VGA cards and CPU support list on ASRock's website as well. ASRock website <http://www.asrock.com>.*

## 1.1 Package Contents

- ASRock Z390 Taichi Ultimate Motherboard (ATX Form Factor)
- ASRock Z390 Taichi Ultimate Quick Installation Guide
- ASRock Z390 Taichi Ultimate Support CD
- 4 x Serial ATA (SATA) Data Cables (Optional)
- 1 x ASRock SLI\_HB\_Bridge\_2S Card (Optional)
- 1 x ASRock WiFi 2.4/5 GHz Antenna (Optional)
- 3 x Screws for M.2 Sockets (Optional)
- 1 x I/O Panel Shield



## 1.2 Specifications

- Platform**
- ATX Form Factor

- CPU**
- Supports 9<sup>th</sup> and 8<sup>th</sup> Gen Intel® Core™ Processors (Socket 1151)
  - IR Digital PWM
  - 12 Power Phase design
  - Supports Intel® Turbo Boost 2.0 Technology
  - Supports Intel® K-Series unlocked CPUs
  - Supports ASRock BCLK Full-range Overclocking
  - Supports ASRock Hyper BCLK Engine II

- Chipset**
- Intel® Z390

- Memory**
- Dual Channel DDR4 Memory Technology
  - 4 x DDR4 DIMM Slots
  - Supports DDR4 4200+(OC)\*/4133(OC)/4000(OC)/3866(OC)/3800(OC)/3733(OC)/3600(OC)/3200(OC)/2933(OC)/2800(OC)/2666/2400/2133 non-ECC, un-buffered memory
- \* Please refer to Memory Support List on ASRock's website for more information. (<http://www.asrock.com/>)
- Supports ECC UDIMM memory modules (operate in non-ECC mode)
  - Max. capacity of system memory: 64GB
  - Supports Intel® Extreme Memory Profile (XMP) 2.0
  - 15μ Gold Contact in DIMM Slots

- Expansion Slot**
- 3 x PCI Express 3.0 x16 Slots (PCIe2/PCIe4/PCIe5: single at x16 (PCIe2); dual at x8 (PCIe2) / x8 (PCIe4); triple at x8 (PCIe2) / x4 (PCIe4) / x4 (PCIe5))\*
- \* Supports NVMe SSD as boot disks
- 2 x PCI Express 3.0 x1 Slots (Flexible PCIe)
  - Supports AMD Quad CrossFireX™, 3-Way CrossFireX™ and CrossFireX™
  - Supports NVIDIA® Quad SLI™ and SLI™
  - Supports NVIDIA® NVLink™ with dual NVIDIA® GeForce® RTX series graphics cards
- \* NVIDIA NVLink Bridge does not come with the package. Please purchase it from NVIDIA® if necessary.

- 1 x Vertical M.2 Socket (Key E) with the bundled WiFi-802.11ac module (on the rear I/O)
- 15µ Gold Contact in VGA PCIe Slot (PCIE2)

## Graphics

\* Intel® UHD Graphics Built-in Visuals and the VGA outputs can be supported only with processors which are GPU integrated.

- Supports Intel® UHD Graphics Built-in Visuals : Intel® Quick Sync Video with AVC, MVC (S3D) and MPEG-2 Full HW Encode1,
- Intel® InTru™ 3D, Intel® Clear Video HD Technology, Intel® Insider™, Intel® UHD Graphics
- DirectX 12
- HWAEncode/Decode: AVC/H.264, HEVC/H.265 8-bit, HEVC/H.265 10-bit, VP8, VP9 8-bit, VP9 10-bit (Decode only), MPEG2, MJPEG, VC-1 (Decode only)
- Dual graphics output: Support HDMI and DisplayPort 1.2 ports by independent display controllers
- Supports HDMI 1.4 with max. resolution up to 4K x 2K (4096x2160) @ 30Hz
- Supports DisplayPort 1.2 with max. resolution up to 4K x 2K (4096x2304) @ 60Hz
- Supports Auto Lip Sync, Deep Color (12bpc), xvYCC and HBR (High Bit Rate Audio) with HDMI 1.4 Port (Compliant HDMI monitor is required)
- Supports HDCP 2.2 with HDMI 1.4 and DisplayPort 1.2 Ports
- Supports 4K Ultra HD (UHD) playback with HDMI 1.4 and DisplayPort 1.2 Ports

## Audio

- 7.1 CH HD Audio with Content Protection (Realtek ALC1220 Audio Codec)
- Premium Blu-ray Audio support
- Supports Surge Protection
- Supports Purity Sound™ 4
  - Nichicon Fine Gold Series Audio Caps
  - 120dB SNR DAC with Differential Amplifier
  - NE5532 Premium Headset Amplifier for Front Panel Audio Connector (Supports up to 600 Ohm headsets)
  - Pure Power-In
  - Direct Drive Technology
  - PCB Isolate Shielding

- Impedance Sensing on Front Out port
- Individual PCB Layers for R/L Audio Channel
- RGB LED
- Gold Audio Jacks
- 15µ Gold Audio Connector
- Supports DTS Connect

## LAN

**1 x 10 Gigabit LAN 10/100/1000/2500/5000/10000 Mb/s (AQUANTIA® AQC107):**

- Supports Wake-On-LAN
- Supports Lightning/ESD Protection
- Supports PXE

**2 x Gigabit LAN 10/100/1000 Mb/s (1 x Intel® I219V, 1 x Intel® I211AT):**

- Supports Wake-On-LAN
- Supports Lightning/ESD Protection
- Supports Dual LAN with Teaming\*

\* Teaming is supported on Windows® 10 RS2 and above.

- Supports Energy Efficient Ethernet 802.3az
- Supports PXE

## Wireless LAN

- Intel® 802.11ac WiFi Module
- Supports IEEE 802.11a/b/g/n/ac
- Supports Dual-Band (2.4/5 GHz)
- Supports high speed wireless connections up to 1733Mbps
- 2 antennas to support 2 (Transmit) x 2 (Receive) diversity technology
- Supports Bluetooth 5.0 + High speed class II
- Supports MU-MIMO

## Rear Panel I/O

- 2 x Antenna Ports
- 1 x PS/2 Mouse/Keyboard Port
- 1 x HDMI Port
- 1 x DisplayPort 1.2
- 1 x Optical SPDIF Out Port
- 3 x USB 3.1 Gen2 Type-A Ports (10 Gb/s) (ReDriver) (Supports ESD Protection)
- 1 x USB 3.1 Gen2 Type-C Port (10 Gb/s) (ReDriver) (Supports ESD Protection)
- 4 x USB 3.1 Gen1 Ports (Intel® Z390) (Supports ESD Protection)

\* Please note that the USB3\_3\_4 do not support USB Keyboard & mouse S3/S4/S5 Wakeup.

- 3 x RJ-45 LAN Ports with LED (ACT/LINK LED and SPEED LED)
- 1 x Clear CMOS Button
- HD Audio Jacks: Rear Speaker / Central / Bass / Line in / Front Speaker / Microphone (Gold Audio Jacks)

## Storage

- 6 x SATA3 6.0 Gb/s Connectors, support RAID (RAID 0, RAID 1, RAID 5, RAID 10, Intel Rapid Storage Technology 16), NCQ, AHCI and Hot Plug\*
- 2 x SATA3 6.0 Gb/s Connectors by ASMedia ASM1061, support NCQ, AHCI and Hot Plug

\* M2\_1, SATA3\_0 and SATA3\_1 share lanes. If either one of them is in use, the others will be disabled.

\* If M2\_2 is occupied by a SATA-type M.2 device, SATA3\_3 will be disabled.

\* M2\_3, SATA3\_4 and SATA3\_5 share lanes. If either one of them is in use, the others will be disabled.

- 1 x Ultra M.2 Socket (M2\_1), support M Key type 2230/2242/2260/2280 M.2 SATA3 6.0 Gb/s module and M.2 PCI Express module up to Gen3 x4 (32 Gb/s)\*\*
- 2 x Ultra M.2 Sockets (M2\_2 and M2\_3), support M Key type 2230/2242/2260/2280/22110 M.2 SATA3 6.0 Gb/s module and M.2 PCI Express module up to Gen3 x4 (32 Gb/s)\*\*

\*\* Supports Intel® Optane™ Technology

\*\* Supports NVMe SSD as boot disks

\*\* Supports ASRock U.2 Kit

## Connector

- 1 x TPM Header
- 1 x Power LED and Speaker Header
- 2 x RGB LED Headers

\* Support in total up to 12V/3A, 36W LED Strip

- 1 x Addressable LED Header

\* Supports in total up to 5V/3A, 15W LED Strip

- 1 x CPU Fan Connector (4-pin)

\* The CPU Fan Connector supports the CPU fan of maximum 1A (12W) fan power.

- 1 x CPU/Water Pump Fan Connector (4-pin) (Smart Fan Speed Control)

- \* The CPU/Water Pump Fan supports the water cooler fan of maximum 2A (24W) fan power.
  - 6 x Chassis/Water Pump Fan Connectors (4-pin) (Smart Fan Speed Control)
- \* The Chassis/Water Pump Fan supports the water cooler fan of maximum 2A (24W) fan power.
- \* CPU\_FAN2/WP, CHA\_FAN1~6/WP can auto detect if 3-pin or 4-pin fan is in use.
  - 1 x 24 pin ATX Power Connector (Hi-Density Power Connector)
  - 1 x 8 pin 12V Power Connector (Hi-Density Power Connector)
  - 1 x 4 pin 12V Power Connector (Hi-Density Power Connector)
  - 1 x Front Panel Audio Connector (15μ Gold Audio Connector)
  - 1 x Thunderbolt AIC Connector (5-pin)
  - 2 x USB 2.0 Headers (Support 3 USB 2.0 ports) (Intel® Z390) (Supports ESD Protection)
  - 2 x USB 3.1 Gen1 Headers (Support 4 USB 3.1 Gen1 ports) (ASMedia ASM1074 hub) (Supports ESD Protection)
  - 1 x Front Panel Type C USB 3.1 Gen2 Header (ASMedia ASM1562 Retimer)
  - 1 x Performance Mode / Easy OC Header
  - 1 x Dr. Debug with LED
  - 1 x Power Button with LED
  - 1 x Reset Button with LED

**BIOS  
Feature**

- 2 x AMI UEFI Legal BIOS with multilingual GUI support (1 x Main BIOS and 1 x Backup BIOS)
- Supports Secure Backup UEFI Technology
- ACPI 6.0 Compliant wake up events
- SMBIOS 2.7 Support
- CPU Core/Cache, GT Core/Cache, DRAM, VTT DDR, PCH 1.0V, VCCIO, CPU PLL 2, VCCSA, VCCPLL, CPU Cold Bug Killer, CPU PLL 1, CLK VDD, DMI, CPU Internal PLL, GT PLL, Ring PLL, System Agent PLL, Memory Controller PLL Voltage Multi-adjustment

**Hardware Monitor**

- Temperature Sensing: CPU, CPU/Water Pump, Chassis/Water Pump Fans
- Fan Tachometer: CPU, CPU/Water Pump, Chassis/Water Pump Fans
- Quiet Fan (Auto adjust chassis fan speed by CPU temperature): CPU, CPU/Water Pump, Chassis/Water Pump Fans
- Fan Multi-Speed Control: CPU, CPU/Water Pump, Chassis/Water Pump Fans
- Voltage monitoring: +12V, +5V, +3.3V, CPU Vcore, DRAM, PCH 1.0V, VCCIO, DRAM VPP, VCCSA, VCCST, DMI, CPU Cold Bug Killer

**OS**

- Microsoft® Windows® 10 64-bit

**Certifications**

- FCC, CE
- ErP/EuP ready (ErP/EuP ready power supply is required)

\* For detailed product information, please visit our website: <http://www.asrock.com>



*Please realize that there is a certain risk involved with overclocking, including adjusting the setting in the BIOS, applying Untied Overclocking Technology, or using third-party overclocking tools. Overclocking may affect your system's stability, or even cause damage to the components and devices of your system. It should be done at your own risk and expense. We are not responsible for possible damage caused by overclocking.*

# 1.3 Motherboard Layout

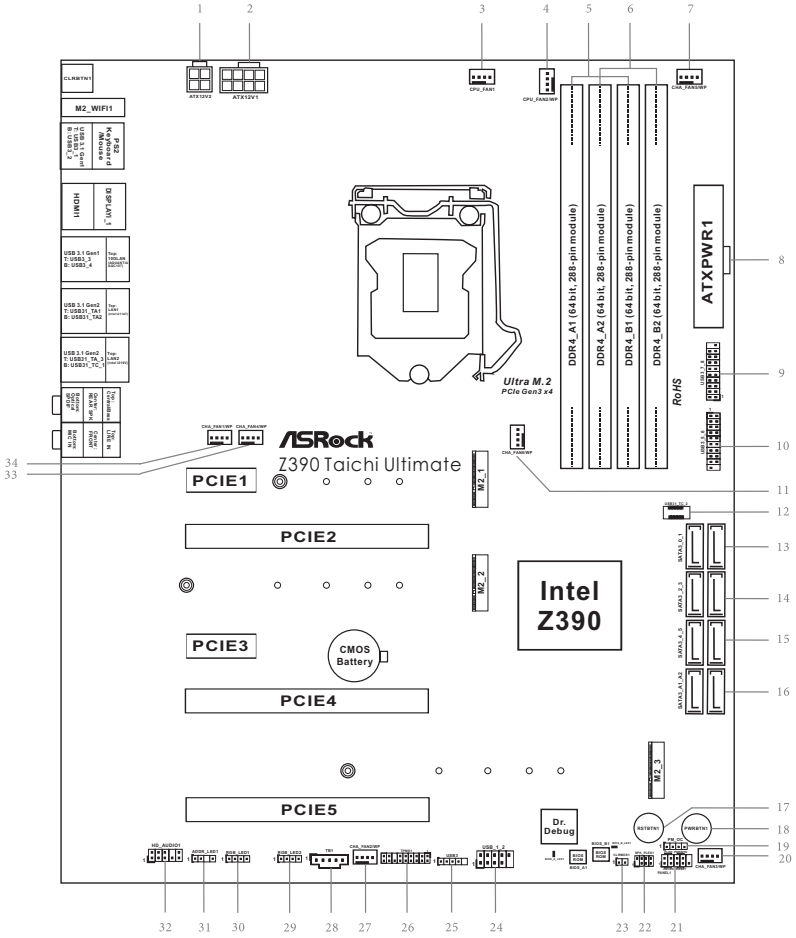

No.	Description
1	ATX 12V Power Connector (ATX12V2)
2	ATX 12V Power Connector (ATX12V1)
3	CPU Fan Connector (CPU_FAN1)
4	CPU Fan / Waterpump Fan Connector (CPU_FAN2/WP)
5	2 x 288-pin DDR4 DIMM Slots (DDR4_A1, DDR4_B1)
6	2 x 288-pin DDR4 DIMM Slots (DDR4_A2, DDR4_B2)
7	Chassis Fan / Waterpump Fan Connector (CHA_FAN5/WP)
8	ATX Power Connector (ATXPWR1)
9	USB 3.1 Gen1 Header (USB3_7_8)
10	USB 3.1 Gen1 Header (USB3_5_6)
11	Chassis Fan / Waterpump Fan Connector (CHA_FAN6/WP)
12	Front Panel Type C USB 3.1 Gen2 Header (USB31_TC_2)
13	SATA3 Connectors (SATA3_0_1)
14	SATA3 Connectors (SATA3_2_3)
15	SATA3 Connectors (SATA3_4_5)
16	SATA3 Connectors (SATA3_A1_A2)
17	Reset Button with LED (RSTBTN1)
18	Power Button with LED (PWRBTN1)
19	Performance Mode / Easy OC Header (PM_OC)
20	Chassis Fan / Waterpump Fan Connector (CHA_FAN3/WP)
21	System Panel Header (PANEL1)
22	Power LED and Speaker Header (SPK_PLED1)
23	Clear CMOS Jumper (CLRMOS1)
24	USB 2.0 Header (USB_1_2)
25	USB 2.0 Header (USB3)
26	TPM Header (TPMS1)
27	Chassis Fan / Waterpump Fan Connector (CHA_FAN2/WP)
28	Thunderbolt AIC Header (TB1)
29	RGB LED Header (RGB_LED2)
30	RGB LED Header (RGB_LED1)
31	Addressable LED Header (ADDR_LED1)
32	Front Panel Audio Header (HD_AUDIO1)
33	Chassis Fan / Waterpump Fan Connector (CHA_FAN4/WP)
34	Chassis Fan / Waterpump Fan Connector (CHA_FAN1/WP)



## 1.4 I/O Panel

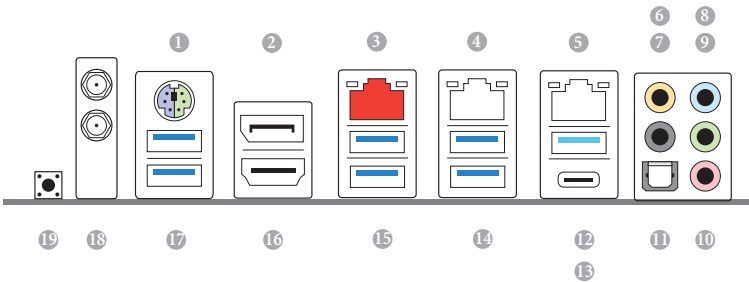

No.	Description	No.	Description
1	PS/2 Mouse/Keyboard Port	11	Optical SPDIF Out Port
2	DisplayPort 1.2	12	USB 3.1 Gen2 Type-A Port (USB31_TA_3)
3	10G LAN RJ-45 Port (AQUANTIA® AQC107)*	13	USB 3.1 Gen2 Type-C Port (USB31_TC_1)
4	LAN RJ-45 Port (Intel® I211AT)**	14	USB 3.1 Gen2 Type-A Ports (USB31_TA_12)
5	LAN RJ-45 Port (Intel® I219V)**	15	USB 3.1 Gen1 Ports (USB3_3_4)****
6	Central / Bass (Orange)	16	HDMI Port
7	Rear Speaker (Black)	17	USB 3.1 Gen1 Ports (USB3_12)
8	Line In (Light Blue)	18	Antenna Ports
9	Front Speaker (Lime)***	19	Clear CMOS Button
10	Microphone (Pink)		

\* There are two LEDs on each LAN port. Please refer to the table below for the LAN port LED indications.

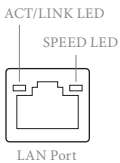

Activity / Link LED		Speed LED	
Status	Description	Status	Description
Off	No Link	Orange	10Mbps/100Mbps/1Gbps/2.5Gbps
Blinking	Data Activity		/5Gbps connection
On	Link	Green	10Gbps connection

\*\* There are two LEDs on each LAN port. Please refer to the table below for the LAN port LED indications.

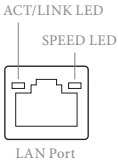

Activity / Link LED		Speed LED	
Status	Description	Status	Description
Off	No Link	Off	10Mbps connection
Blinking	Data Activity	Orange	100Mbps connection
On	Link	Green	1Gbps connection

\*\*\* If you use a 2-channel speaker, please connect the speaker's plug into "Front Speaker Jack". See the table below for connection details in accordance with the type of speaker you use.

Audio Output Channels	Front Speaker (No. 9)	Rear Speaker (No. 7)	Central / Bass (No. 6)	Line In (No. 8)
2	V	--	--	--
4	V	V	--	--
6	V	V	V	--
8	V	V	V	V

\*\*\*\* Please note that the USB3\_3\_4 do not support USB Keyboard & mouse S3/S4/S5 Wakeup.

## 1.5 WiFi-802.11ac Module and ASRock WiFi 2.4/5 GHz Antenna

### WiFi-802.11ac + BT Module

This motherboard comes with an exclusive WiFi 802.11 a/b/g/n/ac + BT v5.0 module (pre-installed on the rear I/O panel) that offers support for WiFi 802.11 a/b/g/n/ac connectivity standards and Bluetooth v5.0. WiFi + BT module is an easy-to-use wireless local area network (WLAN) adapter to support WiFi + BT. Bluetooth v5.0 standard features Smart Ready technology that adds a whole new class of functionality into the mobile devices. BT 5.0 also includes Low Energy Technology and ensures extraordinary low power consumption for PCs. The 2T2R WiFi solution sets a WiFi high speed standard and offers max link rate up to 1733Mbps.

\* The transmission speed may vary according to the environment.



ASRock WiFi 2.4/5 GHz Antenna

## Chapter 2 Installation

This is an ATX form factor motherboard. Before you install the motherboard, study the configuration of your chassis to ensure that the motherboard fits into it.

### Pre-installation Precautions

Take note of the following precautions before you install motherboard components or change any motherboard settings.

- Make sure to unplug the power cord before installing or removing the motherboard components. Failure to do so may cause physical injuries and damages to motherboard components.
- In order to avoid damage from static electricity to the motherboard's components, NEVER place your motherboard directly on a carpet. Also remember to use a grounded wrist strap or touch a safety grounded object before you handle the components.
- Hold components by the edges and do not touch the ICs.
- Whenever you uninstall any components, place them on a grounded anti-static pad or in the bag that comes with the components.
- When placing screws to secure the motherboard to the chassis, please do not over-tighten the screws! Doing so may damage the motherboard.

## 2.1 Installing the CPU



1. Before you insert the 1151-Pin CPU into the socket, please check if the **PnP cap** is on the socket, if the CPU surface is unclean, or if there are any **bent pins** in the socket. Do not force to insert the CPU into the socket if above situation is found. Otherwise, the CPU will be seriously damaged.
2. Unplug all power cables before installing the CPU.

1

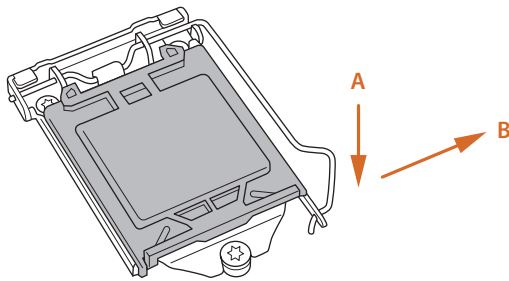

2

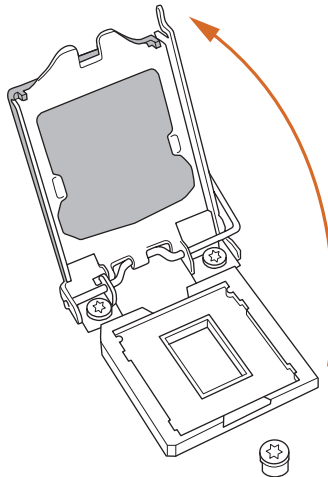

3

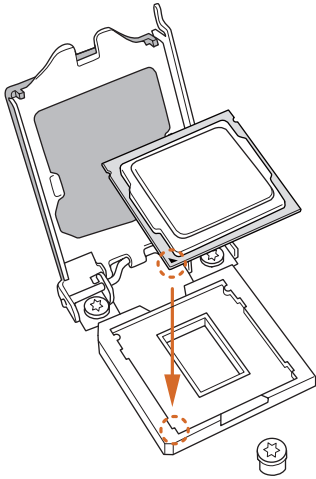

4

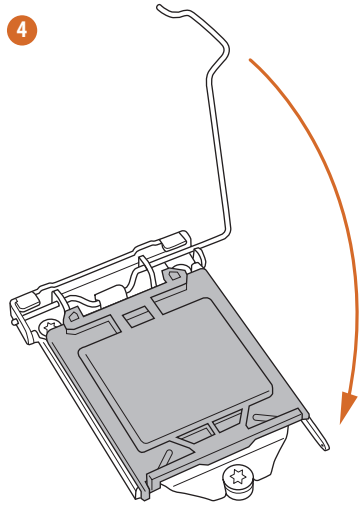

5

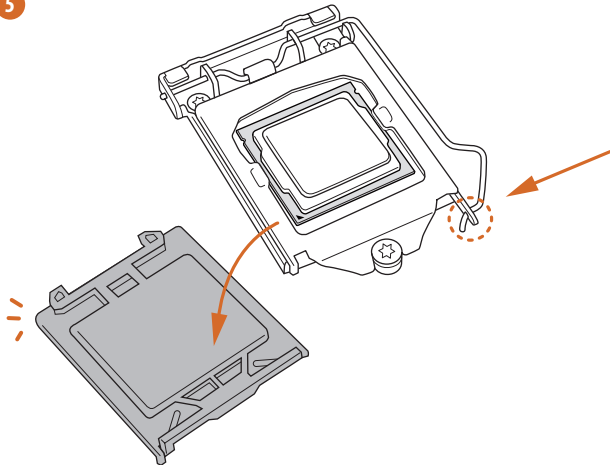



*Please save and replace the cover if the processor is removed. The cover must be placed if you wish to return the motherboard for after service.*

## 2.2 Installing the CPU Fan and Heatsink

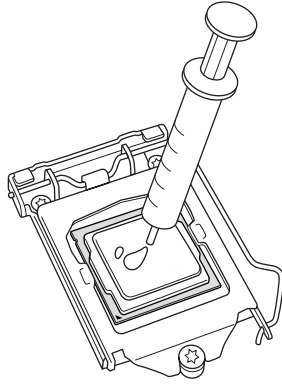
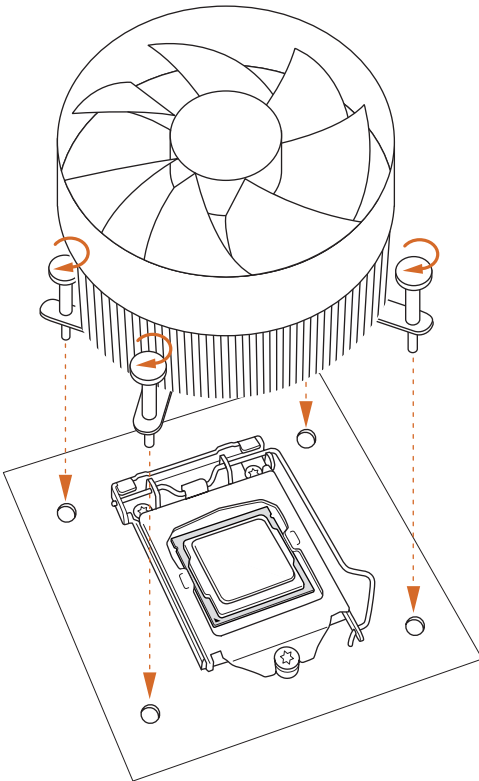
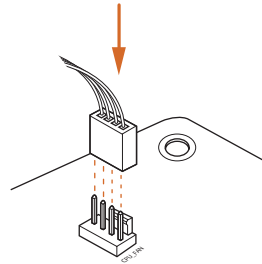
**1****2**



## 2.3 Installing Memory Modules (DIMM)

This motherboard provides four 288-pin DDR4 (Double Data Rate 4) DIMM slots, and supports Dual Channel Memory Technology.



1. For dual channel configuration, you always need to install identical (the same brand, speed, size and chip-type) DDR4 DIMM pairs.
2. It is unable to activate Dual Channel Memory Technology with only one or three memory module installed.
3. It is not allowed to install a DDR, DDR2 or DDR3 memory module into a DDR4 slot; otherwise, this motherboard and DIMM may be damaged.

### Dual Channel Memory Configuration

Priority	DDR4_A1	DDR4_A2	DDR4_B1	DDR4_B2
1		Populated		Populated
2	Populated	Populated	Populated	Populated



*The DIMM only fits in one correct orientation. It will cause permanent damage to the motherboard and the DIMM if you force the DIMM into the slot at incorrect orientation.*

1

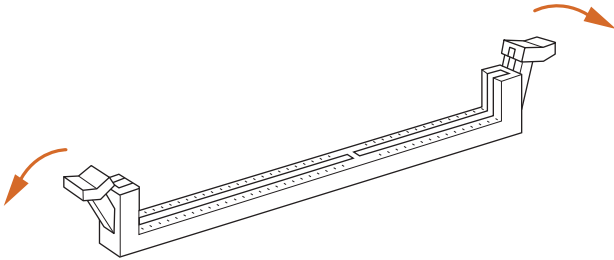

2

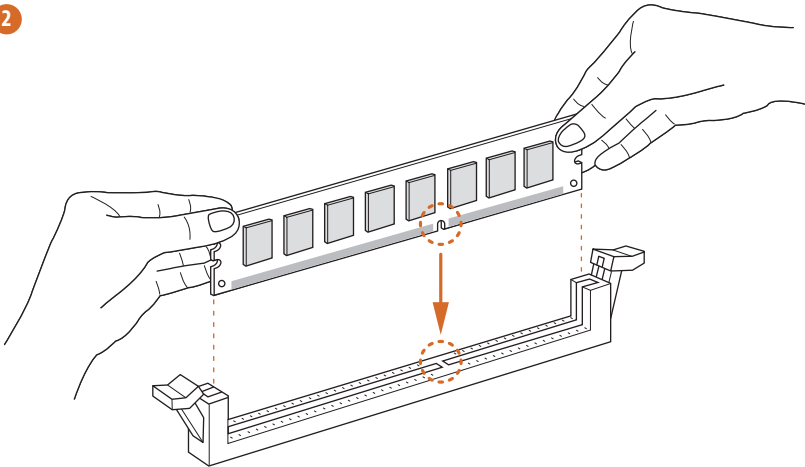

3

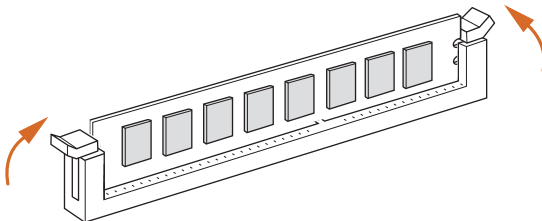

## 2.4 Expansion Slots (PCI Express Slots)

There are 5 PCI Express slots on the motherboard.



*Before installing an expansion card, please make sure that the power supply is switched off or the power cord is unplugged. Please read the documentation of the expansion card and make necessary hardware settings for the card before you start the installation.*

### PCIe slots:

PCIe1 (PCIe 3.0 x1 slot) is used for PCI Express x1 lane width cards.

PCIe2 (PCIe 3.0 x16 slot) is used for PCI Express x16 lane width graphics cards.

PCIe3 (PCIe 3.0 x1 slot) is used for PCI Express x1 lane width cards.

PCIe4 (PCIe 3.0 x16 slot) is used for PCI Express x8 lane width graphics cards.

PCIe5 (PCIe 3.0 x16 slot) is used for PCI Express x4 lane width graphics cards.

### PCIe Slot Configurations

	PCIe2	PCIe4	PCIe5
<b>Single Graphics Card</b>	x16	N/A	N/A
<b>Two Graphics Cards in CrossFireX™ or SLI™ Mode</b>	x8	x8	N/A
<b>Three Graphics Cards in 3-Way CrossFireX™ Mode</b>	x8	x4	x4



*For a better thermal environment, please connect a chassis fan to the motherboard's chassis fan connector (CHA\_FAN1~6/WP) when using multiple graphics cards.*

## 2.5 Jumpers Setup

The illustration shows how jumpers are setup. When the jumper cap is placed on the pins, the jumper is “Short”. If no jumper cap is placed on the pins, the jumper is “Open”.

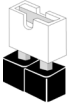

Short



Open

Clear CMOS Jumper  
(CLRMOSE1)  
(see p.8, No. 23)



2-pin Jumper

Short: Clear CMOS  
Open: Default

CLRMOSE1 allows you to clear the data in CMOS. The data in CMOS includes system setup information such as system password, date, time, and system setup parameters. To clear and reset the system parameters to default setup, please turn off the computer and unplug the power cord, then use a jumper cap to short the pins on CLRMOSE1 for 3 seconds. Please remember to remove the jumper cap after clearing the CMOS. If you need to clear the CMOS when you just finish updating the BIOS, you must boot up the system first, and then shut it down before you do the clear-CMOS action.



*The Clear CMOS Button has the same function as the Clear CMOS jumper.*

## 2.6 Onboard Headers and Connectors



Onboard headers and connectors are **NOT** jumpers. Do **NOT** place jumper caps over these headers and connectors. Placing jumper caps over the headers and connectors will cause permanent damage to the motherboard.

System Panel Header  
(9-pin PANEL1)  
(see p.8, No. 21)

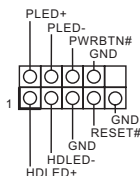

Connect the power button, reset button and system status indicator on the chassis to this header according to the pin assignments below. Note the positive and negative pins before connecting the cables.



**PWRBTN (Power Button):**

Connect to the power button on the chassis front panel. You may configure the way to turn off your system using the power button.

**RESET (Reset Button):**

Connect to the reset button on the chassis front panel. Press the reset button to restart the computer if the computer freezes and fails to perform a normal restart.

**PLED (System Power LED):**

Connect to the power status indicator on the chassis front panel. The LED is on when the system is operating. The LED keeps blinking when the system is in S1/S3 sleep state. The LED is off when the system is in S4 sleep state or powered off (S5).

**HDLED (Hard Drive Activity LED):**

Connect to the hard drive activity LED on the chassis front panel. The LED is on when the hard drive is reading or writing data.

The front panel design may differ by chassis. A front panel module mainly consists of power button, reset button, power LED, hard drive activity LED, speaker and etc. When connecting your chassis front panel module to this header, make sure the wire assignments and the pin assignments are matched correctly.

Power LED and Speaker Header  
 (7-pin SPK\_PLED1)  
 (see p.8, No. 22)

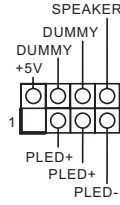

Please connect the chassis power LED and the chassis speaker to this header.

Serial ATA3 Connectors  
 (SATA3\_0\_1:  
 see p.8, No. 13)  
 (SATA3\_2\_3:  
 see p.8, No. 14)  
 (SATA3\_4\_5:  
 see p.8, No. 15)  
 (SATA3\_A1\_A2:  
 see p.8, No. 16)

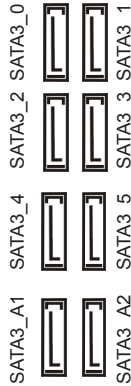

These eight SATA3 connectors support SATA data cables for internal storage devices with up to 6.0 Gb/s data transfer rate.  
 \* M2\_1, SATA3\_0 and SATA3\_1 share lanes. If either one of them is in use, the others will be disabled.  
 \* If M2\_2 is occupied by a SATA-type M.2 device, SATA3\_3 will be disabled.  
 \* M2\_3, SATA3\_4 and SATA3\_5 share lanes. If either one of them is in use, the others will be disabled.

To minimize the boot time, use Intel® Z390 SATA ports (SATA3\_0) for your bootable devices.

USB 2.0 Headers  
(9-pin USB\_1\_2)  
(see p.8, No. 24)

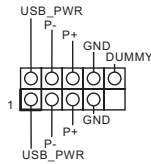

There are two USB 2.0 headers on this motherboard.

(4-pin USB3)  
(see p.8, No. 25)

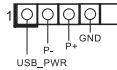

USB 3.1 Gen1 Headers  
(19-pin USB3\_5\_6)  
(see p.8, No. 9)

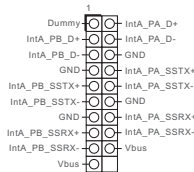

There are two headers on this motherboard. Each USB 3.1 Gen1 header can support two ports.

(19-pin USB3\_7\_8)  
(see p.8, No. 10)

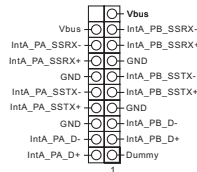

Front Panel Type C USB 3.1 Gen2 Header  
(20-pin USB31\_TC\_2)  
(see p.8, No. 12)



There is one Front Panel Type C USB 3.1 Gen2 Header on this motherboard. This header is used for connecting a USB 3.1 Gen2 module for additional USB 3.1 Gen2 ports.

Front Panel Audio Header  
(9-pin HD\_AUDIO1)  
(see p.8, No. 32)

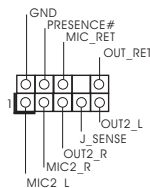

This header is for connecting audio devices to the front audio panel.



1. High Definition Audio supports Jack Sensing, but the panel wire on the chassis must support HDA to function correctly. Please follow the instructions in our manual and chassis manual to install your system.
2. If you use an AC'97 audio panel, please install it to the front panel audio header by the steps below:
  - A. Connect Mic\_IN (MIC) to MIC2\_L.
  - B. Connect Audio\_R (RIN) to OUT2\_R and Audio\_L (LIN) to OUT2\_L.
  - C. Connect Ground (GND) to Ground (GND).
  - D. MIC\_RET and OUT\_RET are for the HD audio panel only. You don't need to connect them for the AC'97 audio panel.
  - E. To activate the front mic, go to the "FrontMic" Tab in the Realtek Control panel and adjust "Recording Volume".

**Chassis/Water Pump Fan Connectors**

- (4-pin CHA\_FAN1/WP)
- (see p.8, No. 34)
- (4-pin CHA\_FAN2/WP)
- (see p.8, No. 27)
- (4-pin CHA\_FAN3/WP)
- (see p.8, No. 20)
- (4-pin CHA\_FAN4/WP)
- (see p.8, No. 33)
- (4-pin CHA\_FAN5/WP)
- (see p.8, No. 7)

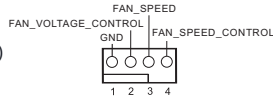

This motherboard provides six 4-Pin water cooling chassis fan connectors. If you plan to connect a 3-Pin chassis water cooler fan, please connect it to Pin 1-3.

- (4-pin CHA\_FAN6/WP)
- (see p.8, No. 11)

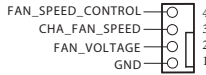

- CPU Fan Connector**  
 (4-pin CPU\_FAN1)  
 (see p.8, No. 3)

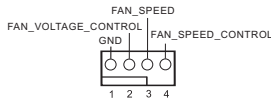

This motherboard provides a 4-Pin CPU fan (Quiet Fan) connector. If you plan to connect a 3-Pin CPU fan, please connect it to Pin 1-3.



CPU/Water Pump Fan Connector  
(4-pin CPU\_FAN2/WP)  
(see p.8, No. 4)

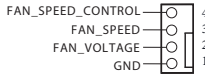

This motherboard provides a 4-Pin water cooling CPU fan connector. If you plan to connect a 3-Pin CPU water cooler fan, please connect it to Pin 1-3.

ATX Power Connector  
(24-pin ATXPWR1)  
(see p.8, No. 8)

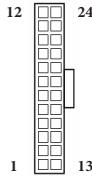

This motherboard provides a 24-pin ATX power connector. To use a 20-pin ATX power supply, please plug it along Pin 1 and Pin 13.

ATX 12V Power Connector  
(8-pin ATX12V1)  
(see p.8, No. 2)

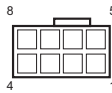

This motherboard provides an 8-pin ATX 12V power connector. To use a 4-pin ATX power supply, please plug it along Pin 1 and Pin 5.

ATX 12V Power Connector  
(4-pin ATX12V2)  
(see p.8, No. 1)



Please connect an ATX 12V power supply to this connector.

\*The power supply plug fits into this connector in only one orientation.

TPM Header  
(17-pin TPMS1)  
(see p.8, No. 26)

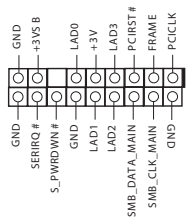

This connector supports Trusted Platform Module (TPM) system, which can securely store keys, digital certificates, passwords, and data. A TPM system also helps enhance network security, protects digital identities, and ensures platform integrity.

Thunderbolt AIC  
Connector  
(5-pin TB1)  
(see p.8, No. 28)



Please connect a Thunderbolt™ add-in card (AIC) to the Thunderbolt AIC connector via the GPIO cable.  
\*Please install the Thunderbolt™ AIC card to PCIE5 (default slot).

RGB LED Headers  
(4-pin RGB\_LED1)  
(see p.8, No. 30)  
(4-pin RGB\_LED2)  
(see p.8, No. 29)



RGB header is used to connect RGB LED extension cable which allows users to choose from various LED lighting effects.

**Caution: Never install the RGB LED cable in the wrong orientation; otherwise, the cable may be damaged.**

\*Please refer to page 54 for further instructions on this header.

Addressable LED Header  
(3-pin ADDR\_LED1)  
(see p.8, No. 31)

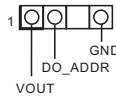

This header is used to connect Addressable LED extension cable which allows users to choose from various LED lighting effects.

**Caution: Never install the Addressable LED cable in the wrong orientation; otherwise, the cable may be damaged.**

\*Please refer to page 55 for further instructions on this header.

Performance Mode / Easy  
OC Header  
(4-pin PM\_OC)  
(see p.8, No. 19)

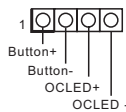

Please connect the OC switch and OC LED indicator on the chassis to this header according to the pin assignments. Note the positive and negative pins before connecting the cables.

## 2.7 Smart Switches

The motherboard has three smart switches: Power Button, Reset Button and Clear CMOS Button.

Power Button  
(PWRBTN1)  
(see p.8, No. 18)



Power Button allows users to quickly turn on/off the system.

Reset Button  
(RSTBTN1)  
(see p.8, No. 17)



Reset Button allows users to quickly reset the system.

Clear CMOS Button  
(CLRBTN1)  
(see p.10, No. 19)



Clear CMOS Button allows users to quickly clear the CMOS values.



*This function is workable only when you power off your computer and unplug the power supply.*

## 2.8 Dr. Debug

Dr. Debug is used to provide code information, which makes troubleshooting even easier. Please see the diagrams below for reading the Dr. Debug codes.

Code	Description
00	Please check if the CPU is installed correctly and then clear CMOS.
0d	Problem related to memory, VGA card or other devices. Please clear CMOS, re-install the memory and VGA card, and remove other USB, PCI devices.
01 - 54 (except 0d), 5A- 60	Problem related to memory. Please re-install the CPU and memory then clear CMOS. If the problem still exists, please install only one memory module or try using other memory modules.
55	The Memory could not be detected. Please re-install the memory and CPU. If the problem still exists, please install only one memory module or try using other memory modules.
61 - 91	Chipset initialization error. Please press reset or clear CMOS.
92 - 99	Problem related to PCI-E devices. Please re-install PCI-E devices or try installing them in other slots. If the problem still exists, please remove all PCI-E devices or try using another VGA card.
A0 - A7	Problem related to IDE or SATA devices. Please re-install IDE and SATA devices. If the problem still exists, please clear CMOS and try removing all SATA devices.
b0	Problem related to memory. Please re-install the CPU and memory. If the problem still exists, please install only one memory module or try using other memory modules.

---

b4 Problem related to USB devices. Please try removing all USB devices.

b7 Problem related to memory. Please re-install the CPU and memory then clear CMOS. If the problem still exists, please install only one memory module or try using other memory modules.

d6 The VGA could not be recognized. Please clear CMOS and try re-installing the VGA card. If the problem still exists, please try installing the VGA card in other slots or use other VGA cards.

d7 The Keyboard and mouse could not be recognized. Please try re-installing the keyboard and mouse.

d8 Invalid Password.

FF Please check if the CPU is installed correctly and then clear CMOS.

## 2.9 SLI™ and Quad SLI™ Operation Guide

This motherboard supports NVIDIA® SLI™ and Quad SLI™ (Scalable Link Interface) technology that allows you to install up to two identical PCI Express x16 graphics cards.



### Requirements

1. You should only use identical SLI™-ready graphics cards that are NVIDIA® certified.
2. Make sure that your graphics card driver supports NVIDIA® SLI™ technology. Download the drivers from the NVIDIA® website: [www.nvidia.com](http://www.nvidia.com)
3. Make sure that your power supply unit (PSU) can provide at least the minimum power your system requires. It is recommended to use a NVIDIA® certified PSU. Please refer to the NVIDIA® website for details.

### 2.9.1 Installing Two SLI™-Ready Graphics Cards

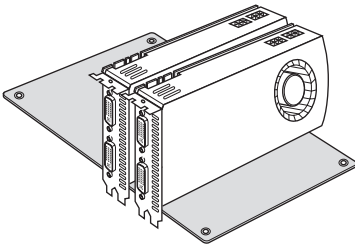

#### Step 1

Insert one graphics card into PCIE2 slot and the other graphics card to PCIE4 slot. Make sure that the cards are properly seated on the slots.

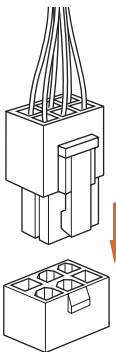

#### Step 2

If required, connect the auxiliary power source to the PCI Express graphics cards.

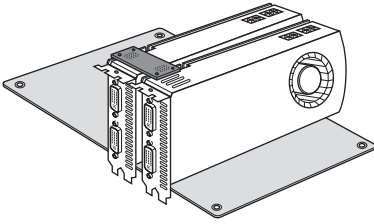

### **Step 3**

Align and insert the ASRock SLI\_HB\_Bridge\_2S Card to the goldfingers on each graphics card. Make sure the ASRock SLI\_HB\_Bridge\_2S Card is firmly in place.



ASRock SLI\_HB\_Bridge\_2S Card

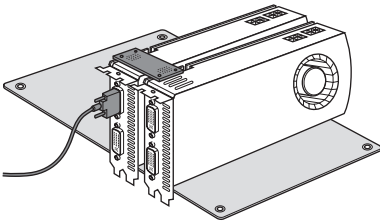

### **Step 4**

Connect a VGA cable or a DVI cable to the monitor connector or the DVI connector of the graphics card that is inserted to PCIE2 slot.

## 2.9.2 Driver Installation and Setup

Install the graphics card drivers to your system. After that, you can enable the Multi-Graphics Processing Unit (GPU) in the NVIDIA<sup>®</sup> nView system tray utility. Please follow the below procedures to enable the multi-GPU.

For SLI<sup>™</sup> and Quad SLI<sup>™</sup> mode



### Step 1

Double-click the NVIDIA Control Panel icon in the Windows<sup>®</sup> system tray.

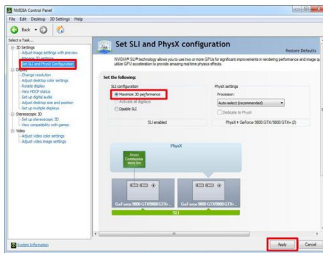

### Step 2

In the left pane, click **Set SLI and PhysX configuration**. Then select **Maximize 3D performance** and click **Apply**.

### Step 3

Reboot your system.

### Step 4

You can freely enjoy the benefits of SLI<sup>™</sup> or Quad SLI<sup>™</sup>.



## 2.10 CrossFireX™, 3-Way CrossFireX™ and Quad CrossFireX™ Operation Guide

This motherboard supports CrossFireX™, 3-way CrossFireX™ and Quad CrossFireX™ that allows you to install up to three identical PCI Express x16 graphics cards.



1. You should only use identical CrossFireX™-ready graphics cards that are AMD certified.
2. Make sure that your graphics card driver supports AMD CrossFireX™ technology. Download the drivers from the AMD's website: [www.amd.com](http://www.amd.com)
3. Make sure that your power supply unit (PSU) can provide at least the minimum power your system requires. It is recommended to use a AMD certified PSU. Please refer to the AMD's website for details.
4. If you pair a 12-pipe CrossFireX™ Edition card with a 16-pipe card, both cards will operate as 12-pipe cards while in CrossFireX™ mode.
5. Different CrossFireX™ cards may require different methods to enable CrossFireX™. Please refer to AMD graphics card manuals for detailed installation guide.

### 2.10.1 Installing Two CrossFireX™-Ready Graphics Cards

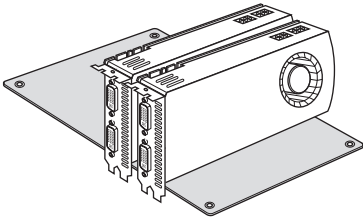

#### Step 1

Insert one graphics card into PCIE2 slot and the other graphics card to PCIE4 slot. Make sure that the cards are properly seated on the slots.



CrossFire Bridge

#### Step 2

Connect two graphics cards by installing a CrossFire Bridge on the CrossFire Bridge Interconnects on the top of the graphics cards. (The CrossFire Bridge is provided with the graphics card you purchase, not bundled with this motherboard. Please refer to your graphics card vendor for details.)

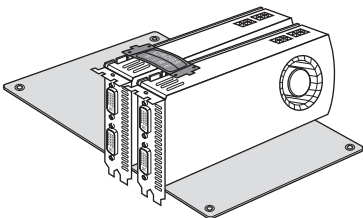

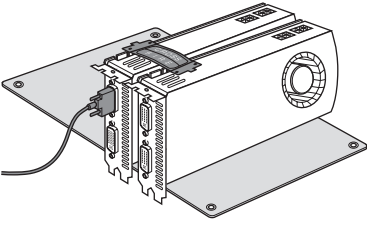
**Step 3**

Connect a VGA cable or a DVI cable to the monitor connector or the DVI connector of the graphics card that is inserted to PCIE2 slot.

## 2.10.2 Installing Three CrossFireX™-Ready Graphics Cards

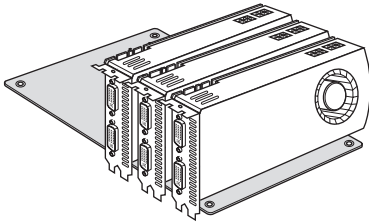

### Step 1

Insert one graphics card into PCIE2 slot, another graphics card to PCIE4 slot, and the other graphics card to PCIE5 slot. Make sure that the cards are properly seated on the slots.



CrossFire Bridge

### Step 2

Use one CrossFire Bridge to connect the graphics cards on PCIE2 and PCIE4 slots, and use the other CrossFire Bridge to connect the graphics cards on PCIE4 and PCIE5 slots. (The CrossFire Bridge is provided with the graphics card you purchase, not bundled with this motherboard. Please refer to your graphics card vendor for details.)

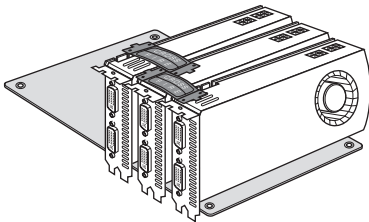

### Step 3

Connect a VGA cable or a DVI cable to the monitor connector or the DVI connector of the graphics card that is inserted to PCIE2 slot.

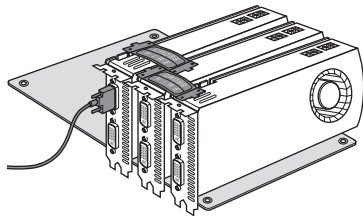

## 2.10.3 Driver Installation and Setup

### Step 1

Power on your computer and boot into OS.

### Step 2

Remove the AMD drivers if you have any VGA drivers installed in your system.



*The Catalyst Uninstaller is an optional download. We recommend using this utility to uninstall any previously installed Catalyst drivers prior to installation. Please check AMD's website for AMD driver updates.*

### Step 3

Install the required drivers and CATALYST Control Center then restart your computer. Please check AMD's website for details.



AMD Catalyst Control Center

### Step 4

Double-click the **AMD Catalyst Control Center** icon in the Windows® system tray.

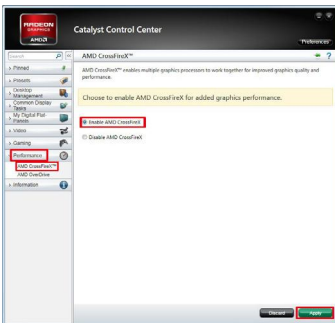

### Step 5

In the left pane, click **Performance** and then **AMD CrossFireX™**. Then select **Enable AMD CrossFireX** and click **Apply**. Select the GPU number according to your graphics card and click **Apply**.

## 2.11 M.2\_SSD (NGFF) Module Installation Guide (M2\_1 and M2\_2)

The M.2, also known as the Next Generation Form Factor (NGFF), is a small size and versatile card edge connector that aims to replace mPCIe and mSATA. The Ultra M.2 Sockets (M2\_1) supports M Key type 2230/2242/2260/2280 M.2 SATA3 6.0 Gb/s module and M.2 PCI Express module up to Gen3 x4 (32 Gb/s). The Ultra M.2 Socket (M2\_2) supports M Key type 2230/2242/2260/2280/22110 M.2 SATA3 6.0 Gb/s module and M.2 PCI Express module up to Gen3 x4 (32 Gb/s).

\* M2\_1, SATA3\_0 and SATA3\_1 share lanes. If either one of them is in use, the others will be disabled.

\* If M2\_2 is occupied by a SATA-type M.2 device, SATA3\_3 will be disabled.

### Installing the M.2\_SSD (NGFF) Module

The following is an example of installing M.2\_SSD (NGFF) module into the M2\_1.

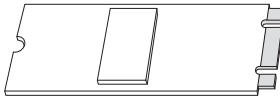

#### Step 1

Prepare a M.2\_SSD (NGFF) module and the screw.

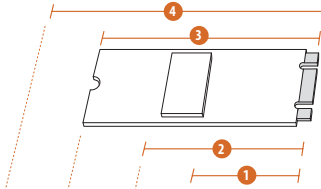

#### Step 2

Depending on the PCB type and length of your M.2\_SSD (NGFF) module, find the corresponding nut location to be used.

No.	1	2	3	4
Nut Location	A	B	C	D
PCB Length	3cm	4.2cm	6cm	8cm
Module Type	Type2230	Type 2242	Type2260	Type 2280

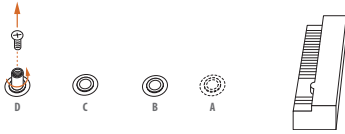
**Step 3**

Move the standoff based on the module type and length. The standoff is placed at the nut location D by default. Skip Step 3 and 4 and go straight to Step 5 if you are going to use the default nut. Otherwise, release the standoff by hand.

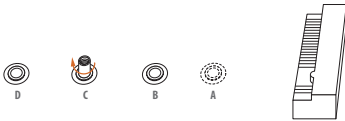
**Step 4**

Peel off the yellow protective film on the nut to be used. Hand tighten the standoff into the desired nut location on the motherboard.

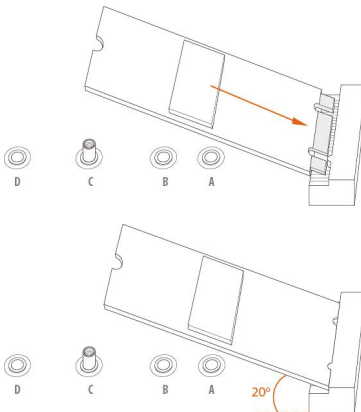
**Step 5**

Gently insert the M.2 (NGFF) SSD module into the M.2 slot. Please be aware that the M.2 (NGFF) SSD module only fits in one orientation.

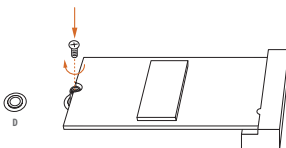
**Step 6**

Tighten the screw with a screwdriver to secure the module into place. Please do not overtighten the screw as this might damage the module.

## 2.12 M.2\_SSD (NGFF) Module Installation Guide (M2\_3)

The M.2, also known as the Next Generation Form Factor (NGFF), is a small size and versatile card edge connector that aims to replace mPCIe and mSATA. The Ultra M.2 Socket (M2\_3) supports M Key type 2230/2242/2260/2280/22110 M.2 SATA3 6.0 Gb/s module and M.2 PCI Express module up to Gen3 x4 (32 Gb/s).

\* M2\_3, SATA3\_4 and SATA3\_5 share lanes. If either one of them is in use, the others will be disabled.

### Installing the M.2\_SSD (NGFF) Module

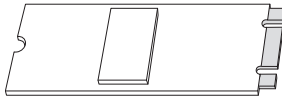

#### Step 1

Prepare a M.2\_SSD (NGFF) module and the screw.

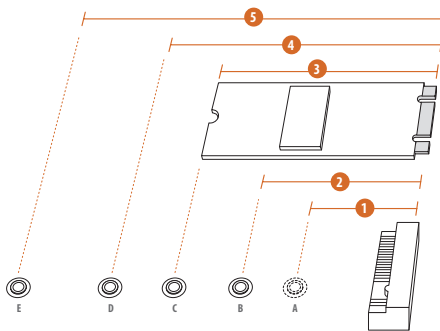

#### Step 2

Depending on the PCB type and length of your M.2\_SSD (NGFF) module, find the corresponding nut location to be used.

No.	1	2	3	4	5
Nut Location	A	B	C	D	E
PCB Length	3cm	4.2cm	6cm	8cm	11cm
Module Type	Type2230	Type 2242	Type2260	Type 2280	Type 22110

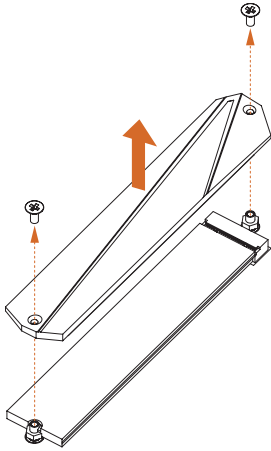

**Step 3**

Before installing a M.2 (NGFF) SSD module, please loosen the screws to remove the M.2 heatsink.

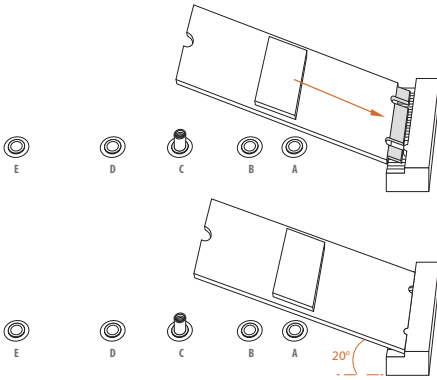

**Step 4**

Gently insert the M.2 (NGFF) SSD module into the M.2 slot. Please be aware that the M.2 (NGFF) SSD module only fits in one orientation.

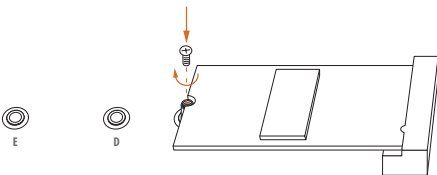

**Step 5**

Tighten the screw with a screwdriver to secure the module into place. Please do not overtighten the screw as this might damage the module.



## M.2\_SSD (NGFF) Module Support List

Vendor	Interface	P/N
ADATA	SATA3	AXNS330E-32GM-B
ADATA	SATA3	AXNS381E-128GM-B
ADATA	SATA3	AXNS381E-256GM-B
ADATA	SATA3	ASU800NS38-256GT-C
ADATA	SATA3	ASU800NS38-512GT-C
ADATA	PCIe3 x4	ASX7000NP-128GT-C
ADATA	PCIe3 x4	ASX8000NP-256GM-C
ADATA	PCIe3 x4	ASX7000NP-256GT-C
ADATA	PCIe3 x4	ASX8000NP-512GM-C
ADATA	PCIe3 x4	ASX7000NP-512GT-C
Apacer	PCIe3 x4	AP240GZ280
Corsair	PCIe3 x4	CSSD-F240GBMP500
Crucial	SATA3	CT120M500SSD4
Crucial	SATA3	CT240M500SSD4
Intel	SATA3	Intel SSDSCKGW080A401/80G
Intel	PCIe3 x4	SSDPEKKF256G7
Intel	PCIe3 x4	SSDPEKKF512G7
Kingston	SATA3	SM2280S3
Kingston	PCIe3 x4	SKC1000/480G
Kingston	PCIe2 x4	SH2280S3/480G
OCZ	PCIe3 x4	RVD400 -M2280-512G (NVME)
PATRIOT	PCIe3 x4	PH240GPM280SSDR NVME
Plextor	PCIe3 x4	PX-128M8PeG
Plextor	PCIe3 x4	PX-1TM8PeG
Plextor	PCIe3 x4	PX-256M8PeG
Plextor	PCIe3 x4	PX-512M8PeG
Plextor	PCIe	PX-G256M6e
Plextor	PCIe	PX-G512M6e
Samsung	PCIe3 x4	SM961 MZVPW128HEGM (NVM)
Samsung	PCIe3 x4	PM961 MZVLW128HEGR (NVME)
Samsung	PCIe3 x4	960 EVO (MZ-V6E250) (NVME)
Samsung	PCIe3 x4	960 EVO (MZ-V6E250BW) (NVME)
Samsung	PCIe3 x4	SM951 (NVME)
Samsung	PCIe3 x4	SM951 (MZHPV256HDGL)
Samsung	PCIe3 x4	SM951 (MZHPV512HDGL)
Samsung	PCIe3 x4	SM951 (NVME)
Samsung	PCIe x4	XP941-512G (MZHPU512HCGL)
SanDisk	PCIe	SD6PP4M-128G
SanDisk	PCIe	SD6PP4M-256G
Team	SATA3	TM4PS4128GMC105
Team	SATA3	TM4PS4256GMC105
Team	SATA3	TM8PS4128GMC105
Team	SATA3	TM8PS4256GMC105

TEAM	PCIe3 x4	TM8FP2240G0C101
TEAM	PCIe3 x4	TM8FP2480GC110
Transcend	SATA3	TS256GMTS400
Transcend	SATA3	TS512GMTS600
Transcend	SATA3	TS512GMTS800
V-Color	SATA3	VLM100-120G-2280B-RD
V-Color	SATA3	VLM100-240G-2280RGB
V-Color	SATA3	VSM100-240G-2280
V-Color	SATA3	VLM100-240G-2280B-RD
WD	SATA3	WDS100T1B0B-00AS40
WD	SATA3	WDS240G1G0B-00RC30
WD	PCIe3 x4	WDS256G1X0C-00ENX0 (NVME)
WD	PCIe3 x4	WDS512G1X0C-00ENX0 (NVME)

For the latest updates of M.2\_SSD (NFGG) module support list, please visit our website for details: <http://www.asrock.com>

---

## Chapter 3 Software and Utilities Operation

### 3.1 Installing Drivers

The Support CD that comes with the motherboard contains necessary drivers and useful utilities that enhance the motherboard's features.

#### Running The Support CD

To begin using the support CD, insert the CD into your CD-ROM drive. The CD automatically displays the Main Menu if "AUTORUN" is enabled in your computer. If the Main Menu does not appear automatically, locate and double click on the file "ASRSETUP.EXE" in the Support CD to display the menu.

#### Drivers Menu

The drivers compatible to your system will be auto-detected and listed on the support CD driver page. Please click **Install All** or follow the order from top to bottom to install those required drivers. Therefore, the drivers you install can work properly.

#### Utilities Menu

The Utilities Menu shows the application software that the motherboard supports. Click on a specific item then follow the installation wizard to install it.

## 3.2 A-Tuning

A-Tuning is ASRock's multi purpose software suite with a new interface, more new features and improved utilities.

### 3.2.1 Installing A-Tuning

A-Tuning can be downloaded from ASRock Live Update & APP Shop. After the installation, you will find the icon "A-Tuning" on your desktop. Double-click the "A-Tuning"  icon, A-Tuning main menu will pop up.

### 3.2.2 Using A-Tuning

There are five sections in A-Tuning main menu: Operation Mode, OC Tweaker, System Info, FAN-Tastic Tuning and Settings.

#### Operation Mode

Choose an operation mode for your computer.

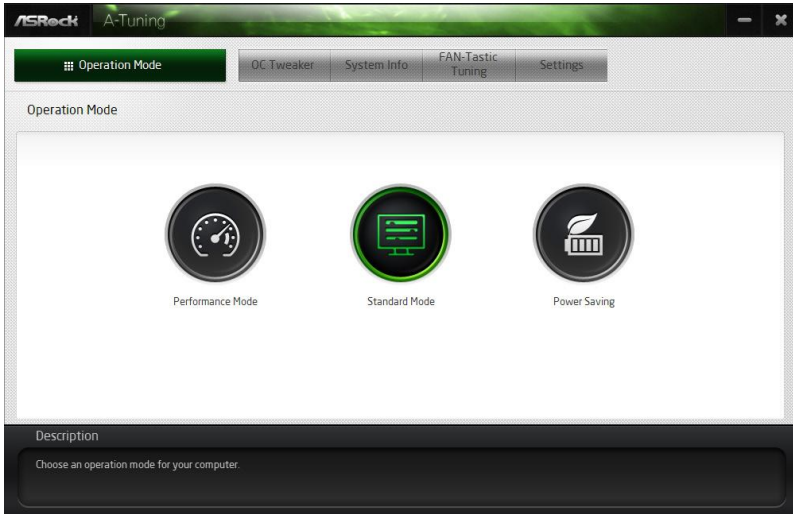

## OC Tweaker

Configurations for overlocking the system.

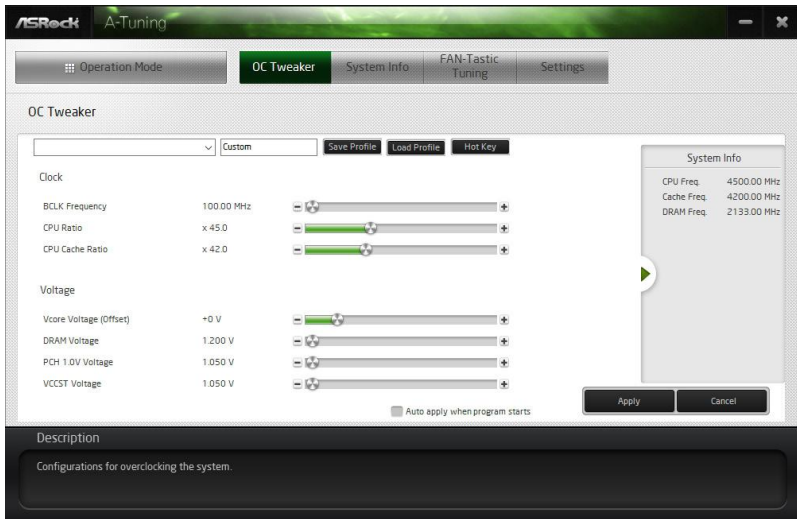

## System Info

View information about the system.

\*The System Browser tab may not appear for certain models.

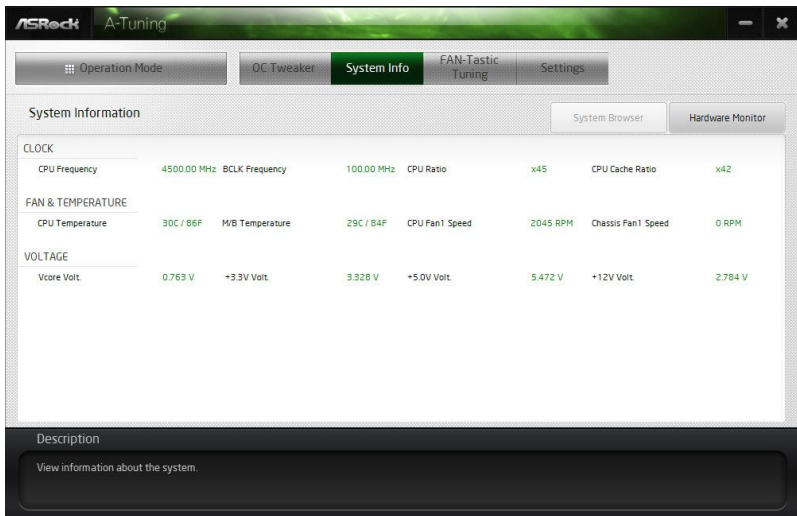

## FAN-Tastic Tuning

Configure up to five different fan speeds using the graph. The fans will automatically shift to the next speed level when the assigned temperature is met.

**FAN-Tastic Tuning**

CPU FAN1

Start FAN Test

Fan Power	Fan Speed
100%	N/A RPM
90%	N/A RPM
80%	N/A RPM
70%	N/A RPM
60%	N/A RPM
50%	N/A RPM
40%	N/A RPM
30%	N/A RPM
20%	N/A RPM
10%	N/A RPM

Auto apply when program starts

Apply Cancel

**Description**

Configure different fan speeds for respective temperatures using the graph. The fans will automatically shift to the next speed level when the assigned temperature is met.

## Settings

Configure ASRock A-Tuning. Click to select "Auto run at Windows Startup" if you want A-Tuning to be launched when you start up the Windows operating system.

**Settings**

Auto run at Windows Startup

Version: 3.0.93

**Description**

Configure ASRock A-Tuning.

### 3.3 ASRock Live Update & APP Shop

The ASRock Live Update & APP Shop is an online store for purchasing and downloading software applications for your ASRock computer. You can quickly and easily install various apps and support utilities. With ASRock Live Update & APP Shop, you can optimize your system and keep your motherboard up to date simply with a few clicks.

Double-click  on your desktop to access ASRock Live Update & APP Shop utility.

*\*You need to be connected to the Internet to download apps from the ASRock Live Update & APP Shop.*

#### 3.3.1 UI Overview

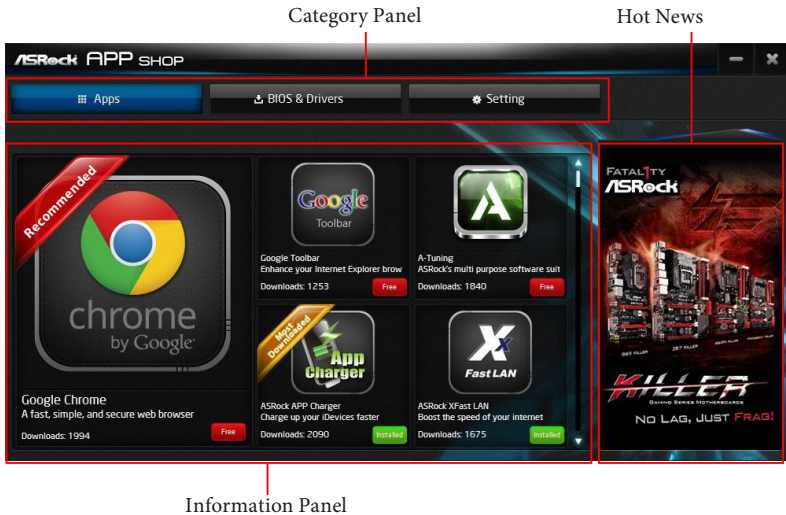

**Category Panel:** The category panel contains several category tabs or buttons that when selected the information panel below displays the relative information.

**Information Panel:** The information panel in the center displays data about the currently selected category and allows users to perform job-related tasks.

**Hot News:** The hot news section displays the various latest news. Click on the image to visit the website of the selected news and know more.

### 3.3.2 Apps

When the "Apps" tab is selected, you will see all the available apps on screen for you to download.

#### Installing an App

##### Step 1

Find the app you want to install.



The most recommended app appears on the left side of the screen. The other various apps are shown on the right. Please scroll up and down to see more apps listed.

You can check the price of the app and whether you have already installed it or not.

 - The red icon displays the price or "Free" if the app is free of charge.

 - The green "Installed" icon means the app is installed on your computer.

##### Step 2

Click on the app icon to see more details about the selected app.



### Step 3

If you want to install the app, click on the red icon  to start downloading.



### Step 4

When installation completes, you can find the green "Installed" icon appears on the upper right corner.

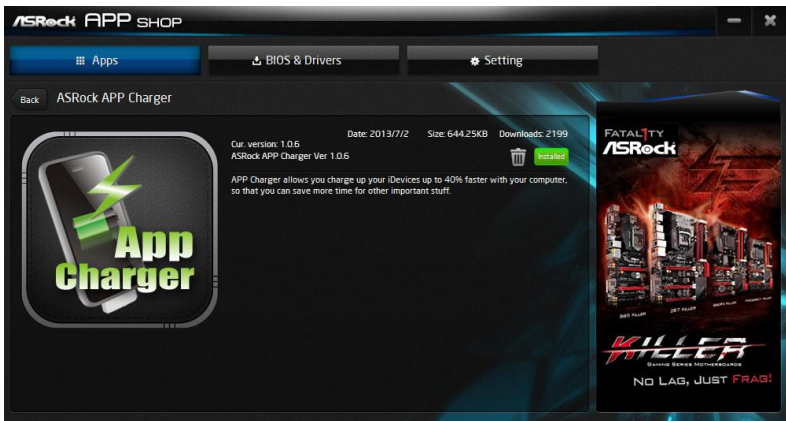

To uninstall it, simply click on the trash can icon .  
\*The trash icon may not appear for certain apps.

## Upgrading an App

You can only upgrade the apps you have already installed. When there is an available new version for your app, you will find the mark of "New Version" appears below the installed app icon.

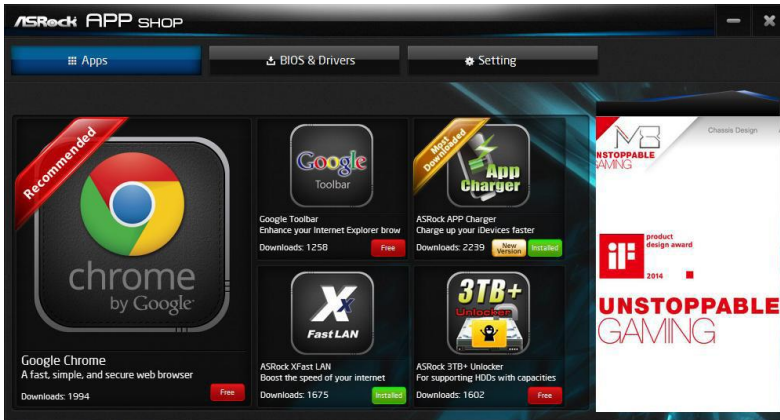

### Step 1

Click on the app icon to see more details.

### Step 2

Click on the yellow icon  to start upgrading.

### 3.3.3 BIOS & Drivers

#### Installing BIOS or Drivers

When the "BIOS & Drivers" tab is selected, you will see a list of recommended or critical updates for the BIOS or drivers. Please update them all soon.

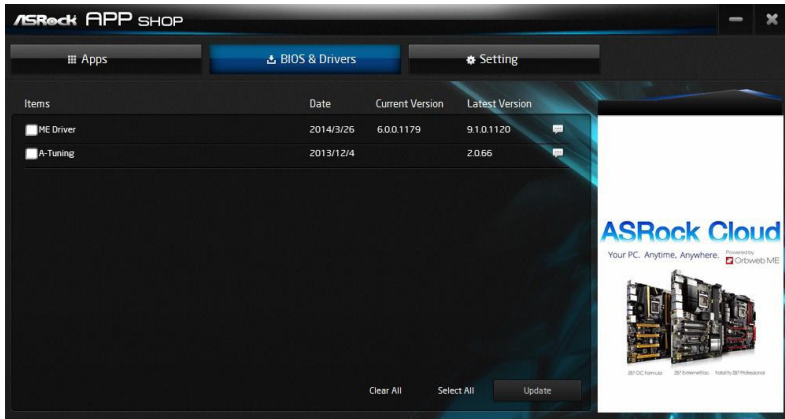

#### **Step 1**

Please check the item information before update. Click on  to see more details.

#### **Step 2**

Click to select one or more items you want to update.

#### **Step 3**

Click Update to start the update process.

### 3.3.4 Setting

In the "Setting" page, you can change the language, select the server location, and determine if you want to automatically run the ASRock Live Update & APP Shop on Windows startup.

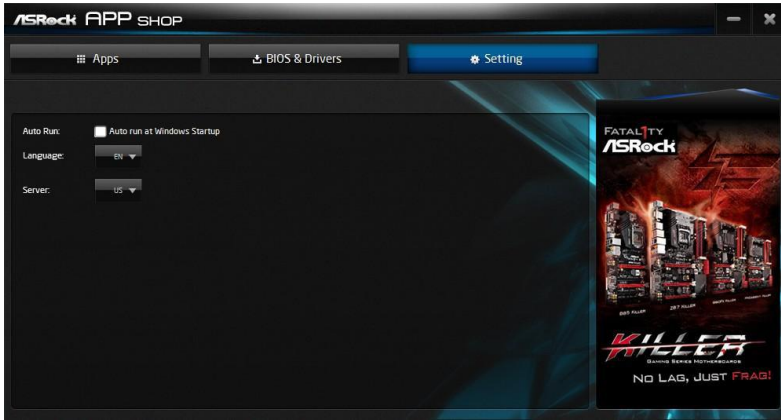

### 3.4 ASRock Polychrome RGB

ASRock Polychrome RGB is a lighting control utility specifically designed for unique individuals with sophisticated tastes to build their own stylish colorful lighting system. Simply by connecting the LED strip, you can customize various lighting schemes and patterns, including Static, Breathing, Strobe, Cycling, Music, Wave and more.

#### Connecting the LED Strip

Connect your RGB LED strips to the **RGB LED Headers (RGB\_LED1, RGB\_LED2)** on the motherboard.

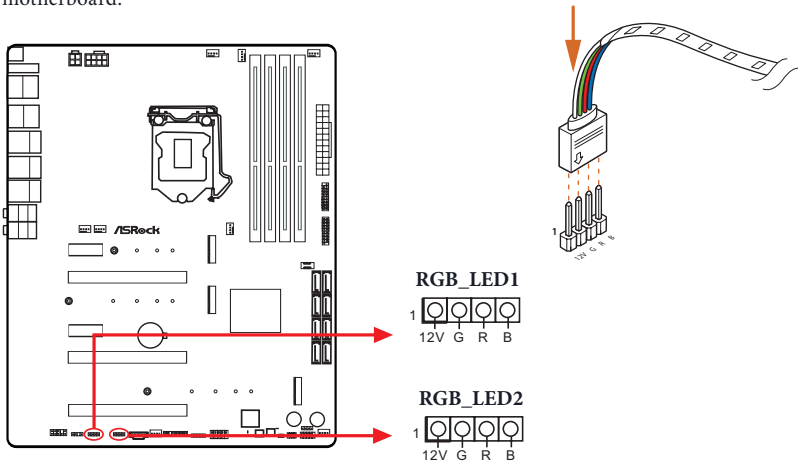

1. Never install the RGB LED cable in the wrong orientation; otherwise, the cable may be damaged.
2. Before installing or removing your RGB LED cable, please power off your system and unplug the power cord from the power supply. Failure to do so may cause damages to motherboard components.



1. Please note that the RGB LED strips do not come with the package.
2. The RGB LED header supports standard 5050 RGB LED strip (12V/G/R/B), with a maximum power rating of 3A (12V) and length within 2 meters.

## Connecting the Addressable RGB LED Strip

Connect your Addressable RGB LED strip to the **Addressable LED Header (ADDR\_LED1)** on the motherboard.

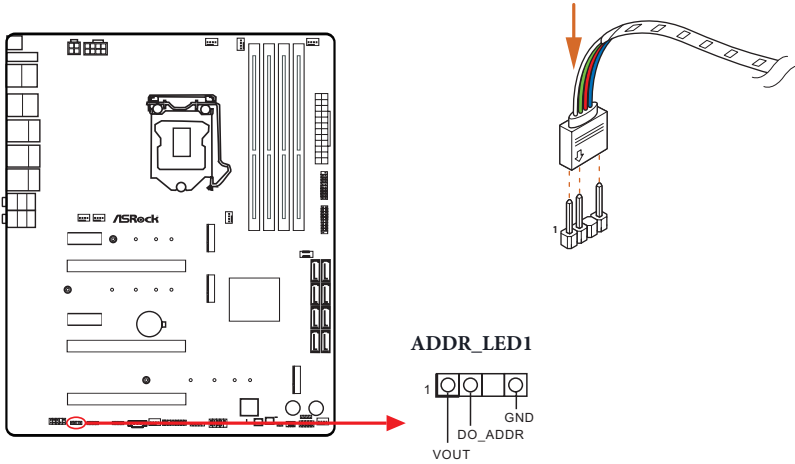

1. Never install the RGB LED cable in the wrong orientation; otherwise, the cable may be damaged.
2. Before installing or removing your RGB LED cable, please power off your system and unplug the power cord from the power supply. Failure to do so may cause damages to motherboard components.



1. Please note that the RGB LED strips do not come with the package.
2. The RGB LED header supports WS2812B addressable RGB LED strip (5V/Data/GND), with a maximum power rating of 3A (5V) and length within 2 meters.

## ASRock Polychrome RGB Utility

Now you can adjust the RGB LED color through the ASRock Polychrome RGB utility. Download this utility from the ASRock Live Update & APP Shop and start coloring your PC style your way!

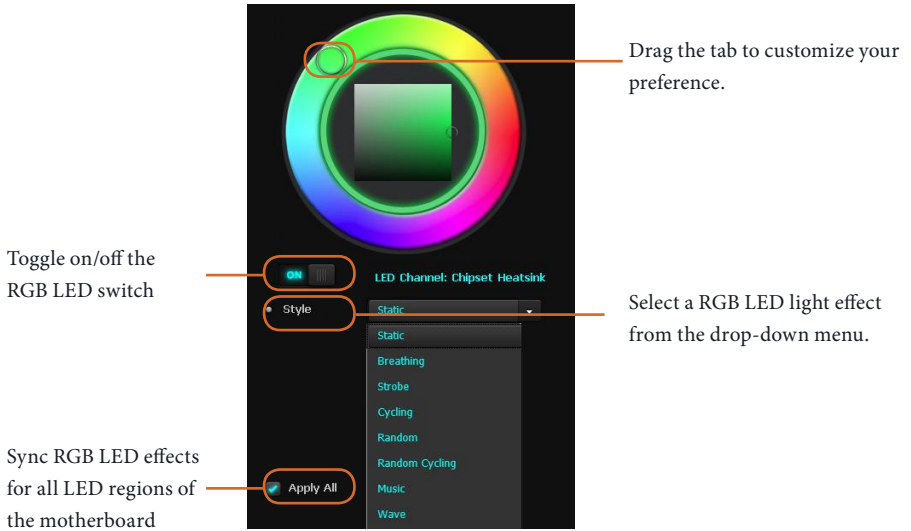

## Chapter 4 UEFI SETUP UTILITY

### 4.1 Introduction

This section explains how to use the UEFI SETUP UTILITY to configure your system. You may run the UEFI SETUP UTILITY by pressing <F2> or <Del> right after you power on the computer, otherwise, the Power-On-Self-Test (POST) will continue with its test routines. If you wish to enter the UEFI SETUP UTILITY after POST, restart the system by pressing <Ctl> + <Alt> + <Delete>, or by pressing the reset button on the system chassis. You may also restart by turning the system off and then back on.



*Because the UEFI software is constantly being updated, the following UEFI setup screens and descriptions are for reference purpose only, and they may not exactly match what you see on your screen.*



## 4.2 EZ Mode

The EZ Mode screen appears when you enter the BIOS setup program by default. EZ mode is a dashboard which contains multiple readings of the system's current status. You can check the most crucial information of your system, such as CPU speed, DRAM frequency, SATA information, fan speed, etc.

Press <F6> or click the "Advanced Mode" button at the upper right corner of the screen to switch to "Advanced Mode" for more options.



No.	Function
1	Help
2	Load UEFI Defaults
3	Save Changes and Exit
4	Discard Changes
5	Change Language
6	Switch to Advanced Mode

## 4.3 Advanced Mode

The Advanced Mode provides more options to configure the BIOS settings. Refer to the following sections for the detailed configurations.

To access the EZ Mode, press <F6> or click the "EZ Mode" button at the upper right corner of the screen.

### 4.3.1 UEFI Menu Bar

The top of the screen has a menu bar with the following selections:

<b>Main</b>	For setting system time/date information
<b>OC Tweaker</b>	For overclocking configurations
<b>Advanced</b>	For advanced system configurations
<b>Tool</b>	Useful tools
<b>H/W Monitor</b>	Displays current hardware status
<b>Security</b>	For security settings
<b>Boot</b>	For configuring boot settings and boot priority
<b>Exit</b>	Exit the current screen or the UEFI Setup Utility

## 4.3.2 Navigation Keys

Use <←> key or <→> key to choose among the selections on the menu bar, and use <↑> key or <↓> key to move the cursor up or down to select items, then press <Enter> to get into the sub screen. You can also use the mouse to click your required item.

Please check the following table for the descriptions of each navigation key.

Navigation Key(s)	Description
+ / -	To change option for the selected items
<Tab>	Switch to next function
<PGUP>	Go to the previous page
<PGDN>	Go to the next page
<HOME>	Go to the top of the screen
<END>	Go to the bottom of the screen
<F1>	To display the General Help Screen
<F5>	Add / Remove Favorite
<F7>	Discard changes and exit the SETUP UTILITY
<F9>	Load optimal default values for all the settings
<F10>	Save changes and exit the SETUP UTILITY
<F12>	Print screen
<ESC>	Jump to the Exit Screen or exit the current screen

## 4.4 Main Screen

When you enter the UEFI SETUP UTILITY, the Main screen will appear and display the system overview.



### My Favorite

Display your collection of BIOS items. Press F5 to add/remove your favorite items.

## 4.5 OC Tweaker Screen

In the OC Tweaker screen, you can set up overclocking features.

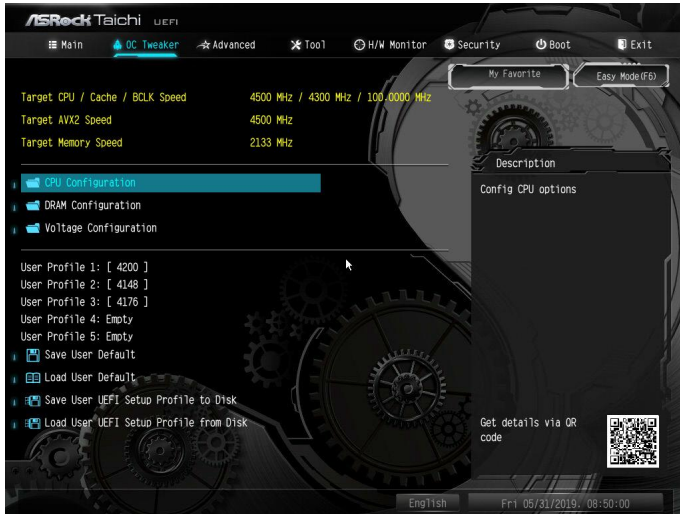

*Because the UEFI software is constantly being updated, the following UEFI setup screens and descriptions are for reference purpose only, and they may not exactly match what you see on your screen.*

### Advanced Turbo

You can use this option to increase your system performance. This option appears only when your CPU supports this function. This option appears only when you adopt K-Series CPU.

### Load Optimized CPU OC Setting

You can use this option to load optimized CPU overclocking setting. Please note that overclocking may cause damage to your CPU and motherboard. It should be done at your own risk and expense.

### Load Optimized GPU OC Setting

You can use this option to load optimized GPU overclocking setting. Please note that overclocking may cause damage to your GPU and motherboard. It should be done at your own risk and expense. This option appears only when you adopt K-Series CPU.

## CPU Configuration

### Performance mode

Intel Performance Mode allows you to do real-time overclocking by pressing the OC button. The OC LED reminds you the Performance mode is ON. Please select the overclocking rule for Performance mode.

[Disabled]

Select this item to disable Intel Performance Mode.

[CPU Ratio +1] , [CPU Ratio +2] and [CPU Ratio +3]

Select the level of overclocking performed.

[Multi Core Enhancement]

Select this item to allow the CPU to perform the highest frequency on all CPU cores simultaneously.

### Multi Core Enhancement

Improve the system's performance by forcing the CPU to perform the highest frequency on all CPU cores simultaneously. Disable to reduce power consumption .

### CPU Ratio

The CPU speed is determined by the CPU Ratio multiplied with the BCLK. Increasing the CPU Ratio will increase the internal CPU clock speed without affecting the clock speed of other components.

### CPU Cache Ratio

The CPU Internal Bus Speed Ratio. The maximum should be the same as the CPU Ratio.

### Minimum CPU Cache Ratio

Set the minimum CPU Internal Bus Speed Ratio.

### BCLK Frequency

The CPU speed is determined by the CPU Ratio multiplied with the BCLK. Increasing the BCLK will increase the internal CPU clock speed but also affect the clock speed of other components.

### BCLK Spread Spectrum

Enable BCLK Spread Spectrum to reduce electromagnetic interference for passing EMI tests. Disable to achieve higher clock speeds when overclocking.

---

## Divider

Configure the BCLK divider.

## Boot Performance Mode

Select the performance state that the BIOS will set before OS handoff.

## Reliability Stress Restrictor

Disable or Enable Reliability Stress Restrictor feature.

## FCLK Frequency

Configure the FCLK Frequency.

## AVX Ratio Offset

AVX Ratio Offset specifies a negative offset from the CPU Ratio for AVX workloads. AVX is a more stressful workload that lower the AVX ratio to ensure maximum possible ratio for SSE workloads.

## BCLK Aware Adaptive Voltage

BCLK Aware Adaptive Voltage enable/disable. When enabled, pcode will be aware of the BCLK frequency when calculating the CPU V/F curves. This is ideal for BCLK OC to avoid high voltage overrides.

## Ring to Core Ratio Offset

Disable Ring to Core Ratio Offset so the ring and core can run at the same frequency.

## Intel SpeedStep Technology

Intel SpeedStep technology allows processors to switch between multiple frequencies and voltage points for better power saving and heat dissipation.

## Intel Turbo Boost Technology

Intel Turbo Boost Technology enables the processor to run above its base operating frequency when the operating system requests the highest performance state.

## Intel Speed Shift Technology

Enable/Disable Intel Speed Shift Technology support. Enabling will expose the CPPC v2 interface to allow for hardware controlled P-states.

## Long Duration Power Limit

Configure Package Power Limit 1 in watts. When the limit is exceeded, the CPU

ratio will be lowered after a period of time. A lower limit can protect the CPU and save power, while a higher limit may improve performance.

### Long Duration Maintained

Configure the period of time until the CPU ratio is lowered when the Long Duration Power Limit is exceeded.

### Short Duration Power Limit

Configure Package Power Limit 2 in watts. When the limit is exceeded, the CPU ratio will be lowered immediately. A lower limit can protect the CPU and save power, while a higher limit may improve performance.

### CPU Core Current Limit

Configure the current limit of the CPU core. A lower limit can protect the CPU and save power, while a higher limit may improve performance.

### GT Current Limit

Configure the current limit of the GT slice. A lower limit can protect the CPU and save power, while a higher limit may improve performance.

### GT Frequency

Configure the frequency of the integrated GPU.

### DRAM Configuration

#### DRAM Tweaker

Fine tune the DRAM settings by leaving marks in checkboxes. Click OK to confirm and apply your new settings.

#### DRAM Timing Configuration

#### Load XMP Setting

Load XMP settings to overclock the memory and perform beyond standard specifications.

#### BCLK Frequency

The CPU speed is determined by the CPU Ratio multiplied with the BCLK. Increasing the BCLK will increase the internal CPU clock speed but also affect the clock speed of other components.

#### DRAM Frequency

If [Auto] is selected, the motherboard will detect the memory module(s) inserted



---

and assign the appropriate frequency automatically.

### DRAM Clock

Choose a frequency to override to clock delay for memory training. DRAM Clock controls memory training only if ASRock Timing Optimization is disabled.

### Primary Timing

#### CAS# Latency (tCL)

The time between sending a column address to the memory and the beginning of the data in response.

#### RAS# to CAS# Delay and Row Precharge (tRCDtRP)

RAS# to CAS# Delay : The number of clock cycles required between the opening of a row of memory and accessing columns within it.

Row Precharge: The number of clock cycles required between the issuing of the precharge command and opening the next row.

#### RAS# Active Time (tRAS)

The number of clock cycles required between a bank active command and issuing the precharge command.

#### Command Rate (CR)

The delay between when a memory chip is selected and when the first active command can be issued.

### Secondary Timing

#### Write Recovery Time (tWR)

The amount of delay that must elapse after the completion of a valid write operation, before an active bank can be precharged.

#### Refresh Cycle Time (tRFC)

The number of clocks from a Refresh command until the first Activate command to the same rank.

#### RAS to RAS Delay (tRRD\_L)

The number of clocks between two rows activated in different banks of the same rank.

#### RAS to RAS Delay (tRRD\_S)

The number of clocks between two rows activated in different banks of the same rank.

### Write to Read Delay (tWTR\_L)

The number of clocks between the last valid write operation and the next read command to the same internal bank.

### Write to Read Delay (tWTR\_S)

The number of clocks between the last valid write operation and the next read command to the same internal bank.

### Read to Precharge (tRTP)

The number of clocks that are inserted between a read command to a row pre-charge command to the same rank.

### Four Activate Window (tFAW)

The time window in which four activates are allowed the same rank.

### CAS Write Latency (tCWL)

Configure CAS Write Latency.

## Third Timing

### tREFI

Configure refresh cycles at an average periodic interval.

### tCKE

Configure the period of time the DDR4 initiates a minimum of one refresh command internally once it enters Self-Refresh mode.

## Turn Around Timing

### tRDRD\_sg

Configure between module read to read delay.

### tRDRD\_dg

Configure between module read to read delay.

### tRDRD\_dr

Configure between module read to read delay.

### tRDRD\_dd

Configure between module read to read delay.

### tRDWR\_sg

Configure between module read to write delay.

### tRDWR\_dg

Configure between module read to write delay.

### tRDWR\_dr

Configure between module read to write delay.

### tRDWR\_dd

Configure between module read to write delay.

### tWRRD\_sg

Configure between module write to read delay.

### tWRRD\_dg

Configure between module write to read delay.

### tWRRD\_dr

Configure between module write to read delay.

### tWRRD\_dd

Configure between module write to read delay.

### tWRWR\_sg

Configure between module write to write delay.

### tWRWR\_dg

Configure between module write to write delay.

### tWRWR\_dr

Configure between module write to write delay.

### tWRWR\_dd

Configure between module write to write delay.

## Round Trip Timing

### RTL Init Value

Configure round trip latency init value for round trip latency training.

### IO-L Init Value

Configure IO latency init value for IO latency training.

### RTL (CH A)

Configure round trip latency for channel A.

### RTL (CH B)

Configure round trip latency for channel B.

### IO-L (CH A)

Configure IO latency for channel A.

### IO-L (CH B)

Configure IO latency for channel B.

### IO-L Offset (CH A)

Configure IO latency offset for channel A.

### IO-L Offset (CH B)

Configure IO latency offset for channel B.

### RFR Delay (CH A)

Configure RFR Delay for Channel A.

### RFR Delay (CH B)

Configure RFR Delay for Channel B.

### ODT Setting

#### ODT WR (A1)

Configure the memory on die termination resistors' WR for channel A1.

#### ODT WR (A2)

Configure the memory on die termination resistors' WR for channel A2.

#### ODT WR (B1)

Configure the memory on die termination resistors' WR for channel B1.

### ODT WR (B2)

Configure the memory on die termination resistors' WR for channel B2.

### ODT NOM (A1)

Use this to change ODT (CH A1) Auto/Manual settings. The default is [Auto].

### ODT NOM (A2)

Use this to change ODT (CH A2) Auto/Manual settings. The default is [Auto].

### ODT NOM (B1)

Use this to change ODT (CH B1) Auto/Manual settings. The default is [Auto].

### ODT NOM (B2)

Use this to change ODT (CH B2) Auto/Manual settings. The default is [Auto].

### ODT PARK (A1)

Configure the memory on die termination resistors' PARK for channel A1.

### ODT PARK (A2)

Configure the memory on die termination resistors' PARK for channel A2.

### ODT PARK (B1)

Configure the memory on die termination resistors' PARK for channel B1.

### ODT PARK (B2)

Configure the memory on die termination resistors' PARK for channel B2.

## COMP Setting

### RCOMP0: DQ ODT (Read)

Default is 121.

### RCOMP1: DQ /CLK Ron (Drive Strength)

Default is 75.

### RCOMP2: CMD/CTL Ron (Drive Strength)

Default is 100.

## DQ ODT Driving

Adjust ODT Driving for better signal. Default is 60.

## DQ Driving

Adjust DQ Driving for better signal. Default is 26.

## Command Driving

Adjust Command Driving for better signal. Default is 20.

## Control Driving

Adjust Control Driving for better signal. Default is 20.

## Clock Driving

Adjust Clock Driving for better signal. Default is 26.

## DQ Slew Rate

Adjust DQ Slew Rate for better signal. Default is 59.

## Command Slew Rate

Adjust Command Slew Rate for better signal. Default is 53 for 1N, 89 for 2N.

## Control Slew Rate

Adjust Control Slew Rate for better signal. Default is 53.

## Clock Slew Rate

Adjust Clock Slew Rate for better signal. Default is 53.

## MRS Setting

### MRS tCL

Configure the tCL for Memory MRS MR0.

### MRS tWRtRTP

Configure the tWRtRTP for Memory MRS MRC.

### MRS tCWL

Configure the tCWL for Memory MRS MR2.

### MRS tCCD\_L

Configure the tCL for Memory MRS MR6.

## Advanced Setting

### ASRock Timing Optimization

---

Configure the fast path through the MRC.

### Realtime Memory Timing

Configure the realtime memory timings.

[Enabled] The system will allow performing realtime memory timing changes after MRC\_DONE.

### Command Tristate

Configure the Command Tristate Support.

### Exit On Failure

Configure the Exit On Failure for MRC training steps.

### Reset On Training Fail

Reset system if the MRC training fails.

### MRC Fast Boot

Enable Memory Fast Boot to skip DRAM memory training for booting faster.

### Voltage Configuration

#### CPU Core/Cache Voltage

Configure the voltage for the CPU Core/Cache.

#### CPU Load-Line Calibration

CPU Load-Line Calibration helps prevent CPU voltage droop when the system is under heavy loading.

#### GT Core/Cache Voltage

Configure the voltage for the integrated GPU Core/Cache.

#### GT Load-Line Calibration

GT Load-Line Calibration helps prevent integrated GPU voltage droop when the system is under heavy load.

#### DRAM Voltage

Use this to configure DRAM Voltage. The default value is [Auto].

#### DRAM Activating Power Supply

Configure the voltage for the DRAM Activating Power Supply.

### VTT DDR Voltage

Configure the VTT DDR Voltage.

### PCH +1.05 Voltage

Configure the chipset voltage (1.05V).

### VCCIO Voltage

Configure the voltage for the VCCIO.

### CPU PLL Voltage

Configure the voltage for the CPU PLL.

### CPU PLL2 Voltage

Configure the voltage for the CPU PLL2.

### VCCSA Voltage

Configure the voltage for the VCCSA.

### VCC PLL Voltage

Configure the voltage for the VCC PLL.

### CPU Cold Bug Killer Voltage

Cold Bug Killer Voltage. Recommended to set for Ln2 benching. It will solve most of CPU cold bug.

### CLK VDD Voltage

Configure the voltage for the CLK VDD.

### DMI Voltage

Configure the voltage for the DMI.

### CPU Internal PLL Voltage

Default is 0.900V. Each step is 0.015V. Adding 9- 15 steps will helps CPU PLL to lock internal clock during High frequency under Ln2 cooling. For example: 1.020V - 1.125V will be proper value. But the voltage level will be different on each processor. User has to find the best value for your own processor. CPU Vcore Voltage must higher than CPU Internal PLL Voltage, or your processor will hang.



---

## GT PLL Voltage

Default is 0.900V. Each step is 0.015V. Adding 9 -15 steps will help CPU PLL to lock internal clock during High frequency under Ln2 cooling. For example: 1.020V - 1.125V will be proper value. Bu the voltage level will be different on each processor. User has to find the best value for user's own processor.

## Ring PLL Voltage

Default is 0.900V. Each step is 0.015V. Adding 9 -15 steps will help CPU PLL to lock internal clock during High frequency under Ln2 cooling. For example: 1.020V - 1.125V will be proper value. Bu the voltage level will be different on each processor. User has to find the best value for user's own processor.

## System Agent PLL Voltage

Default is 0.900V. Each step is 0.015V. Adding 9 -15 steps will help CPU PLL to lock internal clock during High frequency under Ln2 cooling. For example: 1.020V - 1.125V will be proper value. Bu the voltage level will be different on each processor. User has to find the best value for user's own processor.

## Memory Controller PLL Voltage

Default is 0.900V. Each step is 0.015V. Adding 9 -15 steps will help CPU PLL to lock internal clock during High frequency under Ln2 cooling. For example: 1.020V - 1.125V will be proper value. Bu the voltage level will be different on each processor. User has to find the best value for user's own processor.

## Save User Default

Type a profile name and press enter to save your settings as user default.

## Load User Default

Load previously saved user defaults.

## Save User UEFI Setup Profile to Disk

It helps you to save current UEFI settings as an user profile to disk.

## Load User UEFI Setup Profile from Disk

You can load previous saved profile from the disk.

## 4.6 Advanced Screen

In this section, you may set the configurations for the following items: CPU Configuration, Chipset Configuration, Storage Configuration, Intel(R) Thunderbolt, Super IO Configuration, ACPI Configuration, USB Configuration and Trusted Computing.

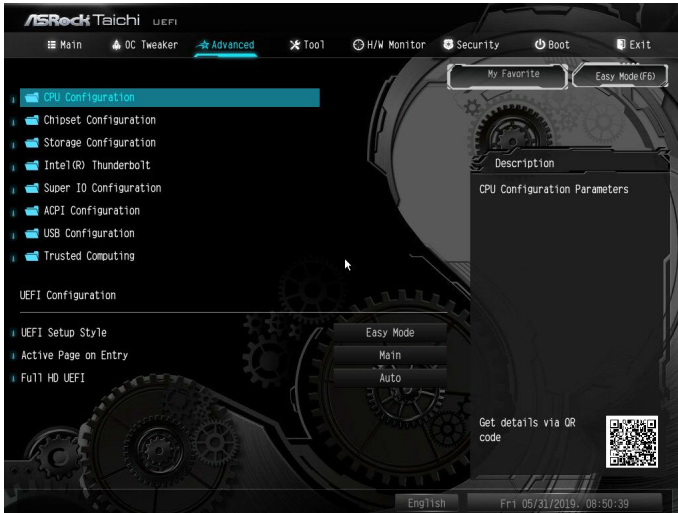

*Setting wrong values in this section may cause the system to malfunction.*

### UEFI Configuration

#### UEFI Setup Style

Select the default mode when entering the UEFI setup utility.

#### Active Page on Entry

Select the default page when entering the UEFI setup utility.

#### Full HD UEFI

When [Auto] is selected, the resolution will be set to 1920 x 1080 if the monitor supports Full HD resolution. If the monitor does not support Full HD resolution, then the resolution will be set to 1024 x 768. When [Disable] is selected, the resolution will be set to 1024 x 768 directly.

## 4.6.1 CPU Configuration



### Intel Hyper Threading Technology

Intel Hyper Threading Technology allows multiple threads to run on each core, so that the overall performance on threaded software is improved.

### Active Processor Cores

Select the number of cores to enable in each processor package.

### CPU C States Support

Enable CPU C States Support for power saving. It is recommended to keep C3, C6, C7 and C10 all enabled for better power saving.

### Enhanced Halt State (C1E)

Enable Enhanced Halt State (C1E) for lower power consumption.

### CPU C3 State Support

Enable C3 sleep state for lower power consumption.

### CPU C6 State Support

Enable C6 sleep state for lower power consumption.

### CPU C7 State Support

Enable C7 sleep state for lower power consumption.

### **CPU C10 State Support**

Enable C10 sleep state for lower power consumption.

### **Package C State Support**

Enable CPU, PCIe, Memory, Graphics C State Support for power saving.

### **CFG Lock**

This item allows you to disable or enable the CFG Lock.

### **CPU Thermal Throttling**

Enable CPU internal thermal control mechanisms to keep the CPU from overheating.

### **Intel Virtualization Technology**

Intel Virtualization Technology allows a platform to run multiple operating systems and applications in independent partitions, so that one computer system can function as multiple virtual systems.

### **Hardware Prefetcher**

Automatically prefetch data and code for the processor. Enable for better performance.

### **Adjacent Cache Line Prefetch**

Automatically prefetch the subsequent cache line while retrieving the currently requested cache line. Enable for better performance.

### **Software Guard Extensions (SGX)**

Use this item to enable or disable Software Controlled Software Guard Extensions (SGX).

## 4.6.2 Chipset Configuration



### Primary Graphics Adapter

Select a primary VGA.

### Above 4G Decoding

Enable or disable 64bit capable Devices to be decoded in Above 4G Address Space (only if the system supports 64 bit PCI decoding).

### VT-d

Intel® Virtualization Technology for Directed I/O helps your virtual machine monitor better utilize hardware by improving application compatibility and reliability, and providing additional levels of manageability, security, isolation, and I/O performance.

### PCIe1 Link Speed

Select the link speed for PCIe1.

### PCIe2 Link Speed

Select the link speed for PCIe2.

### PCIe3 Link Speed

Select the link speed for PCIe3.

### PCIe4 Link Speed

Select the link speed for PCIe4.

### PCIe5 Link Speed

Select the link speed for PCIe5.

### PCI Express Native Control

Select Enable for enhanced PCI Express power saving in OS.

### PCIe ASPM Support

This option enables/disables the ASPM support for all CPU downstream devices.

### PCH PCIe ASPM Support

This option enables/disables the ASPM support for all PCH PCIe devices.

### DMI ASPM Support

This option enables/disables the control of ASPM on CPU side of the DMI Link.

### PCH DMI ASPM Support

This option enables/disables the ASPM support for all PCH DMI devices.

### Share Memory

Configure the size of memory that is allocated to the integrated graphics processor when the system boots up.

### IGPU Multi-Monitor

Select disable to disable the integrated graphics when an external graphics card is installed.  
Select enable to keep the integrated graphics enabled at all times.

### Inte(R) Ethernet Connection I219-V

Enable or disable the onboard network interface controller (Intel® I219V).

### Inte(R) Ethernet Controller I211

Enable or disable the onboard network interface controller (Intel® I211AT).

### aQuantia 10G LAN

Enable or disable the onboard network interface controller (aQuantia® AQC107).

### Onboard HD Audio

Enable/disable onboard HD audio. Set to Auto to enable onboard HD audio and

---

automatically disable it when a sound card is installed.

### **Front Panel**

Enable/disable front panel HD audio.

### **Onboard HDMI HD Audio**

Enable audio for the onboard digital outputs.

### **Onboard WAN Device**

Enable/disable the onboard WAN device.

### **WAN Radio**

Enable/disable the WiFi module's connectivity.

### **Bluetooth**

Enable/disable the bluetooth.

### **Deep Sleep**

Configure deep sleep mode for power saving when the computer is shut down.

### **Restore on AC/Power Loss**

Select the power state after a power failure. If [Power Off] is selected, the power will remain off when the power recovers. If [Power On] is selected, the system will start to boot up when the power recovers.

### **Turn On Onboard LED in S5**

Turn on/off the LED in the ACPI S5 state.

### **Restore Onboard LED Default**

Restore the onboard LED default value.

### **BIOS Backup Switch**

Configure BIOS Backup Switch function.

### **Onboard Debug Port LED**

Enable/disable the onboard Dr. Debug LED.

## 4.6.3 Storage Configuration



### SATA Controller(s)

Enable/disable the SATA controllers.

### SATA Mode Selection

[AHCI] Supports new features that improve performance.

[Intel RST Premium (RAID)] Combine multiple disk drives into a logical unit.

### SATA Aggressive Link Power Management

SATA Aggressive Link Power Management allows SATA devices to enter a low power state during periods of inactivity to save power. It is only supported by AHCI mode.

### Hard Disk S.M.A.R.T.

S.M.A.R.T stands for Self-Monitoring, Analysis, and Reporting Technology. It is a monitoring system for computer hard disk drives to detect and report on various indicators of reliability.

### Third Party SATA 3 Controller

Enable or disable the third party SATA3 controller.



---

## Third Party SATA3 Mode

[AHCI] Supports new features that improve performance.

## 4.6.4 Intel® Thunderbolt



### Discrete Thunderbolt(TM) Support

Enable or disable the Discrete Thunderbolt(TM) Support.

### Thunderbolt Boot Support

Enabled to allow booting from Bootable devices which are present behind Thunderbolt.

### Thunderbolt Usb Support

Enabled to allow booting from Usb devices which are present behind Thunderbolt.

### Titan Ridge Workaround for OSUP

Enable or disable Titan Ridge Workaround for OSUP.

### Security Level

This item allows you to choose a security level for the Thunderbolt ports.

### SW SMI on TBT hot-plug

When enabled, BIOS generates software SMI to assign resource to TBT devices.

### ACPI Notify on TBT Hot-plug

When enabled, BIOS generates ACPI Notify.

---

## Windows 10 Thunderbolt support

Specify Windows 10 Thunderbolt support level.

Disabled: No OS native support.

Enabled: OS Native support only. no RTD3.

## 4.6.5 Super IO Configuration



### PS2 Y-Cable

Enable the PS2 Y-Cable or set this option to Auto.

## 4.6.6 ACPI Configuration



### Suspend to RAM

Select disable for ACPI suspend type S1. It is recommended to select auto for ACPI S3 power saving.

### PS/2 Keyboard S4/S5 Wakeup Support

Allow the system to be waked up by a PS/2 Keyboard in S4/S5.

### PCIE Devices Power On

Allow the system to be waked up by a PCIE device and enable wake on LAN.

### I219 LAN Power On

Allow the system to be waked up by I219 LAN.

### RTC Alarm Power On

Allow the system to be waked up by the real time clock alarm. Set it to By OS to let it be handled by your operating system.

### USB Keyboard/Remote Power On

Allow the system to be waked up by an USB keyboard or remote controller.

### USB Mouse Power On

Allow the system to be waked up by an USB mouse.

## 4.6.7 USB Configuration

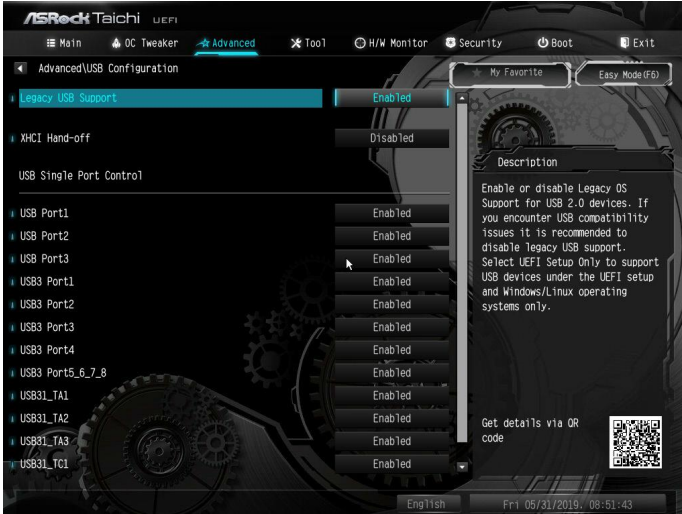

### Legacy USB Support

Enable or disable Legacy OS Support for USB 2.0 devices. If you encounter USB compatibility issues it is recommended to disable legacy USB support. Select UEFI Setup Only to support USB devices under the UEFI setup and Windows/Linux operating systems only.

### XHCI Hand-off

This is a workaround for OSes without XHCI hand-off support. The XHCI ownership change should be claimed by XHCI driver.

## 4.6.8 Trusted Computing



### Security Device Support

Enable or disable BIOS support for security device.

## 4.7 Tools



### UEFI Tech Service

Contact ASRock Tech Service if you are having trouble with your PC. Please setup network configuration before using UEFI Tech Service.

### Easy RAID Installer

Easy RAID Installer helps you to copy the RAID driver from the support CD to your USB storage device. After copying the drivers please change the SATA mode to RAID, then you can start installing the operating system in RAID mode.

### Instant Flash

Save UEFI files in your USB storage device and run Instant Flash to update your UEFI.

### Internet Flash - DHCP (Auto IP), Auto

ASRock Internet Flash downloads and updates the latest UEFI firmware version from our servers for you. Please setup network configuration before using Internet Flash.

\*For BIOS backup and recovery purpose, it is recommended to plug in your USB pen drive before using this function.



## Secure Backup UEFI

Whenever one of the ROM images are outdated or corrupted, switch to the other flash ROM and execute Secure Backup UEFI to duplicate the current working ROM image to the secondary flash ROM..



*This motherboard has two BIOS chips, an active BIOS (BIOS\_A) and a backup BIOS (BIOS\_B), which enhances the safety and stability of your system. Use "Secure Backup UEFI" to duplicate a working copy of the BIOS files to the active BIOS to ensure normal system operation. Normally, the system will work on the active BIOS. However if the active BIOS is corrupted or damaged, after several failed boot attempts, the backup BIOS will take over. For safety issues, users are not able to update the backup BIOS manually. Users may refer to the BIOS LEDs (BIOS\_A\_LED or BIOS\_B\_LED) to identify which BIOS is currently activated.*

## Network Configuration

Use this to configure internet connection settings for Internet Flash.

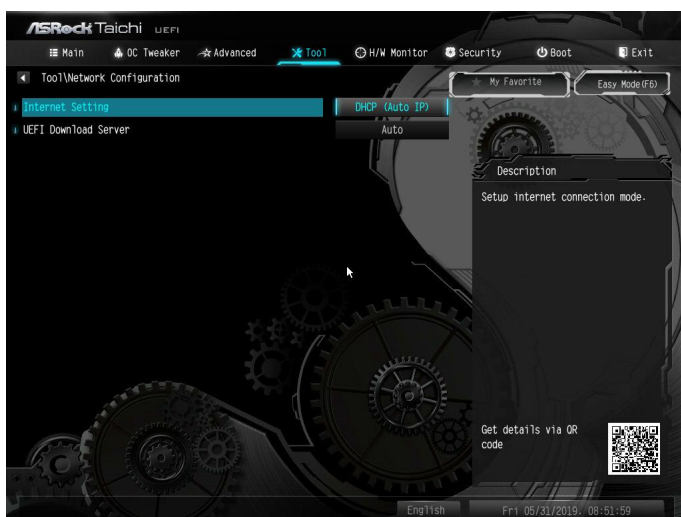

### Internet Setting

Enable or disable sound effects in the setup utility.

### UEFI Download Server

Select a server to download the UEFI firmware.

## 4.8 Hardware Health Event Monitoring Screen

This section allows you to monitor the status of the hardware on your system, including the parameters of the CPU temperature, motherboard temperature, fan speed and voltage.



### Fan Tuning

Measure Fan Min Duty Cycle.

### Fan-Tastic Tuning

Select a fan mode for CPU Fan 1, or choose Customize to set 5 CPU temperatures and assign a respective fan speed for each temperature.

### CPU Fan 1 Setting

Select a fan mode for CPU Fan 1, or choose Customize to set 5 CPU temperatures and assign a respective fan speed for each temperature.

### CPU Fan 1 Step Up

Set the value of CPU Fan 1 Step Up.

### CPU Fan 1 Step Down

Set the value of CPU Fan 1 Step Down.

### CPU\_FAN2 / W\_Pump Switch

Select CPU Water Pump mode.

---

## CPU Fan 2 Control Mode

Select PWM mode or DC mode for CPU Fan 2.

## CPU Fan 2 Setting

Select a fan mode for CPU Fan 2, or choose Customize to set 5 CPU temperatures and assign a respective fan speed for each temperature.

## CPU Fan 2 Temp Source

Select a fan temperature source for CPU Fan 2.

## CPU Fan 2 Step Up

Set the value of CPU Fan 2 Step Up.

## CPU Fan 2 Step Down

Set the value of CPU Fan 2 Step Down.

## CHA\_FAN1 / W\_Pump Switch

Select Chassis Fan 1 or Water Pump mode.

## Chassis Fan 1 Control Mode

Select PWM mode or DC mode for Chassis Fan 1.

## Chassis Fan 1 Setting

Select a fan mode for Chassis Fan 1, or choose Customize to set 5 CPU temperatures and assign a respective fan speed for each temperature.

## Chassis Fan 1 Temp Source

Select a fan temperature source for Chassis Fan 1.

## Chassis Fan 1 Step Up

Set the value of Chassis Fan 1 Step Up.

## Chassis Fan 1 Step Down

Set the value of Chassis Fan 1 Step Down.

## CHA\_FAN2 / W\_Pump Switch

Select Chassis Fan 2 or Water Pump mode.

## Chassis Fan 2 Control Mode

Select PWM mode or DC mode for Chassis Fan 2.

### Chassis Fan 2 Setting

Select a fan mode for Chassis Fan 2, or choose Customize to set 5 CPU temperatures and assign a respective fan speed for each temperature.

### Chassis Fan 2 Temp Source

Select a fan temperature source for Chassis Fan 2.

### Chassis Fan 2 Step Up

Set the value of Chassis Fan 2 Step Up.

### Chassis Fan 2 Step Down

Set the value of Chassis Fan 2 Step Down.

### CHA\_FAN3 / W\_Pump Switch

Select Chassis Fan 3 or Water Pump mode.

### Chassis Fan 3 Control Mode

Select PWM mode or DC mode for Chassis Fan 3.

### Chassis Fan 3 Setting

Select a fan mode for Chassis Fan 3, or choose Customize to set 5 CPU temperatures and assign a respective fan speed for each temperature.

### Chassis Fan 3 Temp Source

Select a fan temperature source for Chassis Fan 3.

### Chassis Fan 3 Step Up

Set the value of Chassis Fan 3 Step Up.

### Chassis Fan 3 Step Down

Set the value of Chassis Fan 3 Step Down.

### CHA\_FAN4 / W\_Pump Switch

Select Chassis Fan 4 or Water Pump mode.

### Chassis Fan 4 Control Mode

Select PWM mode or DC mode for Chassis Fan 4.

---

### Chassis Fan 4 Setting

Select a fan mode for Chassis Fan 4, or choose Customize to set 5 CPU temperatures and assign a respective fan speed for each temperature.

### Chassis Fan 4 Temp Source

Select a fan temperature source for Chassis Fan 4.

### Chassis Fan 4 Step Up

Set the value of Chassis Fan 4 Step Up.

### Chassis Fan 4 Step Down

Set the value of Chassis Fan 4 Step Down.

### CHA\_FAN5 / W\_Pump Switch

Select Chassis Fan 5 or Water Pump mode.

### Chassis Fan 5 Control Mode

Select PWM mode or DC mode for Chassis Fan 5.

### Chassis Fan 5 Setting

Select a fan mode for Chassis Fan 5, or choose Customize to set 5 CPU temperatures and assign a respective fan speed for each temperature.

### Chassis Fan 5 Temp Source

Select a fan temperature source for Chassis Fan 5.

### Chassis Fan 5 Step Up

Set the value of Chassis Fan 5 Step Up.

### Chassis Fan 5 Step Down

Set the value of Chassis Fan 5 Step Down.

### CHA\_FAN6 / W\_Pump Switch

Select Chassis Fan 6 or Water Pump mode.

### Chassis Fan 6 Control Mode

Select PWM mode or DC mode for Chassis Fan 6.

### Chassis Fan 6 Setting

Select a fan mode for Chassis Fan 6, or choose Customize to set 5 CPU temperatures

and assign a respective fan speed for each temperature.

### Chassis Fan 6 Temp Source

Select a fan temperature source for Chassis Fan 6.

### Chassis Fan 6 Step Up

Set the value of Chassis Fan 6 Step Up.

### Chassis Fan 6 Step Down

Set the value of Chassis Fan 6 Step Down.

### Over Temperature Protection

When Over Temperature Protection is enabled, the system automatically shuts down when the motherboard is overheated.

## 4.9 Security Screen

In this section you may set or change the supervisor/user password for the system. You may also clear the user password.



### Supervisor Password

Set or change the password for the administrator account. Only the administrator has authority to change the settings in the UEFI Setup Utility. Leave it blank and press enter to remove the password.

### User Password

Set or change the password for the user account. Users are unable to change the settings in the UEFI Setup Utility. Leave it blank and press enter to remove the password.

### Secure Boot

Use this item to enable or disable support for Secure Boot.

### Intel(R) Platform Trust Technology

Enable/disable Intel PTT in ME. Disable this option to use discrete TPM Module.

## 4.10 Boot Screen

This section displays the available devices on your system for you to configure the boot settings and the boot priority.

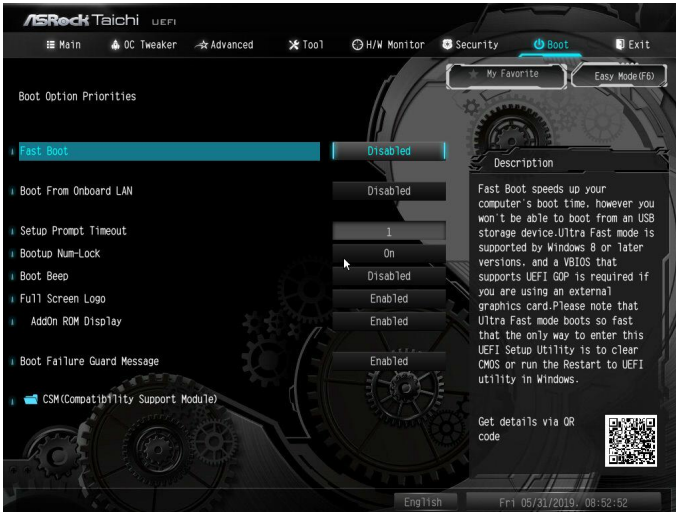

### Fast Boot

Fast Boot minimizes your computer's boot time. In fast mode you may not boot from an USB storage device. The VBIOS must support UEFI GOP if you are using an external graphics card. Please notice that Ultra Fast mode will boot so fast that the only way to enter this UEFI Setup Utility is to Clear CMOS or run the Restart to UEFI utility in Windows.

### Boot From Onboard LAN

Allow the system to be waked up by the onboard LAN.

### Setup Prompt Timeout

Configure the number of seconds to wait for the setup hot key.

### Bootup Num-Lock

Select whether Num Lock should be turned on or off when the system boots up.

### Boot Beep

Select whether the Boot Beep should be turned on or off when the system boots up. Please note that a buzzer is needed.



## Full Screen Logo

Enable to display the boot logo or disable to show normal POST messages.

## AddOn ROM Display

Enable AddOn ROM Display to see the AddOn ROM messages or configure the AddOn ROM if you've enabled Full Screen Logo. Disable for faster boot speed.

## Boot Failure Guard Message

If the computer fails to boot for a number of times the system automatically restores the default settings.

## CSM (Compatibility Support Module)



## CSM

Enable to launch the Compatibility Support Module. Please do not disable unless you're running a WHCK test.

## Launch PXE OpROM Policy

Select UEFI only to run those that support UEFI option ROM only. Select Legacy only to run those that support legacy option ROM only. Select Do not launch to not execute both legacy and UEFI option ROM.

### Launch Storage OpROM Policy

Select UEFI only to run those that support UEFI option ROM only. Select Legacy only to run those that support legacy option ROM only. Select Do not launch to not execute both legacy and UEFI option ROM.

### Other PCI Device ROM Priority

For PCI devices other than Network. Mass storage or Video defines which OpROM to launch.

## 4.11 Exit Screen

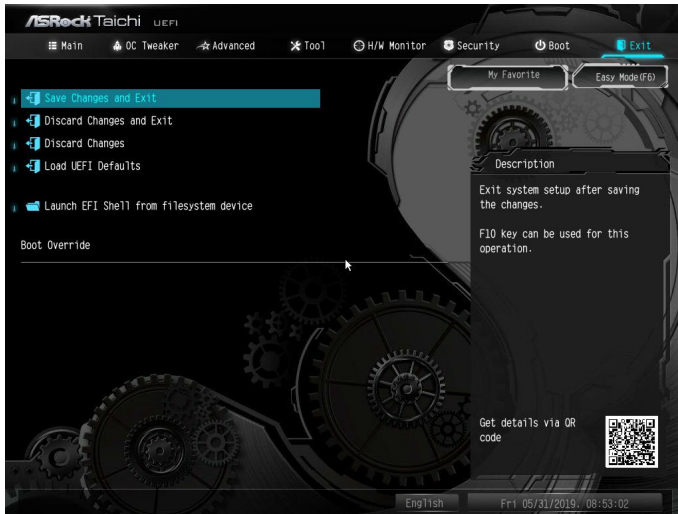

### Save Changes and Exit

When you select this option the following message, “Save configuration changes and exit setup?” will pop out. Select [OK] to save changes and exit the UEFI SETUP UTILITY.

### Discard Changes and Exit

When you select this option the following message, “Discard changes and exit setup?” will pop out. Select [OK] to exit the UEFI SETUP UTILITY without saving any changes.

### Discard Changes

When you select this option the following message, “Discard changes?” will pop out. Select [OK] to discard all changes.

### Load UEFI Defaults

Load UEFI default values for all options. The F9 key can be used for this operation.

### Launch EFI Shell from filesystem device

Copy shellx64.efi to the root directory to launch EFI Shell.

---

## Contact Information

If you need to contact ASRock or want to know more about ASRock, you're welcome to visit ASRock's website at <http://www.asrock.com>; or you may contact your dealer for further information. For technical questions, please submit a support request form at <https://event.asrock.com/tsd.asp>

### **ASRock Incorporation**

2F., No.37, Sec. 2, Jhongyang S. Rd., Beitou District,

Taipei City 112, Taiwan (R.O.C.)

### **ASRock EUROPE B.V.**

Bijsterhuizen 11-11

6546 AR Nijmegen

The Netherlands

Phone: +31-24-345-44-33

Fax: +31-24-345-44-38

### **ASRock America, Inc.**

13848 Magnolia Ave, Chino, CA91710

U.S.A.

Phone: +1-909-590-8308

Fax: +1-909-590-1026

# DECLARATION OF CONFORMITY

Per FCC Part 2 Section 2.1077(a)



**Responsible Party Name:** ASRock Incorporation

**Address:** 13848 Magnolia Ave, Chino, CA91710

**Phone/Fax No:** +1-909-590-8308/+1-909-590-1026

hereby declares that the product

**Product Name :** Motherboard

**Model Number :** Z390 Taichi Ultimate

Conforms to the following specifications:

FCC Part 15, Subpart B, Unintentional Radiators

## Supplementary Information:

This device complies with part 15 of the FCC Rules. Operation is subject to the following two conditions: (1) This device may not cause harmful interference, and (2) this device must accept any interference received, including interference that may cause undesired operation.

Representative Person's Name: James

Signature:

A handwritten signature in black ink, appearing to read 'James', written over a horizontal line.

Date : May 12, 2017

# EU Declaration of Conformity

# ASRock®

For the following equipment:

**Motherboard**

(Product Name)

**Z390 Taichi Ultimate / ASRock**

(Model Designation / Trade Name)

**ASRock Incorporation**

(Manufacturer Name)

**2F, No.37, Sec. 2, Jhongyang S. Rd., Beitou District, Taipei City 112, Taiwan (R.O.C.)**

(Manufacturer Address)

**EMC —Directive 2014/30/EU (from April 20th, 2016)**

EN 55022:2010/AC:2011 Class B

EN 55024:2010/A1:2015

EN 55032:2012+AC:2013 Class B

EN 61000-3-3:2013

EN 61000-3-2:2014

**RED—Directive 2014/53/EU**

EN 300 328 V2.1.1

EN 301 489-17 V3.1.1

EN 301 893 V2.1.1

EN 301 489-3 V2.1.1

EN 300 220 V3.1.1

**LVD —Directive 2014/35/EU (from April 20th, 2016)**

EN 60950-1 : 2011+ A2: 2013

EN 60950-1 : 2006/A12: 2011

RoHS — Directive 2011/65/EU

CE marking



(EU conformity marking)

**ASRock EUROPE B.V.**

(Company Name)

**Bijsterhuizen 1111 6546 AR Nijmegen The Netherlands**

(Company Address)

Person responsible for making this declaration:

(Name, Surname)

**A.V.P**

(Position / Title)

**August 24, 2018**

(Date)

P/N: 15G062117002AK V1.2