

Version 1.0

Published March 2016

Copyright©2016 ASRock INC. All rights reserved.



## Copyright Notice:

No part of this documentation may be reproduced, transcribed, transmitted, or translated in any language, in any form or by any means, except duplication of documentation by the purchaser for backup purpose, without written consent of ASRock Inc.

Products and corporate names appearing in this documentation may or may not be registered trademarks or copyrights of their respective companies, and are used only for identification or explanation and to the owners' benefit, without intent to infringe.

## Disclaimer:

Specifications and information contained in this documentation are furnished for informational use only and subject to change without notice, and should not be construed as a commitment by ASRock. ASRock assumes no responsibility for any errors or omissions that may appear in this documentation.

With respect to the contents of this documentation, ASRock does not provide warranty of any kind, either expressed or implied, including but not limited to the implied warranties or conditions of merchantability or fitness for a particular purpose.

In no event shall ASRock, its directors, officers, employees, or agents be liable for any indirect, special, incidental, or consequential damages (including damages for loss of profits, loss of business, loss of data, interruption of business and the like), even if ASRock has been advised of the possibility of such damages arising from any defect or error in the documentation or product.



This device complies with Part 15 of the FCC Rules. Operation is subject to the following two conditions:

- (1) this device may not cause harmful interference, and
- (2) this device must accept any interference received, including interference that may cause undesired operation.

## CALIFORNIA, USA ONLY

The Lithium battery adopted on this motherboard contains Perchlorate, a toxic substance controlled in Perchlorate Best Management Practices (BMP) regulations passed by the California Legislature. When you discard the Lithium battery in California, USA, please follow the related regulations in advance.

“Perchlorate Material-special handling may apply, see [www.dtsc.ca.gov/hazardouswaste/perchlorate](http://www.dtsc.ca.gov/hazardouswaste/perchlorate)”

**ASRock Website: <http://www.asrock.com>**

## AUSTRALIA ONLY

Our goods come with guarantees that cannot be excluded under the Australian Consumer Law. You are entitled to a replacement or refund for a major failure and compensation for any other reasonably foreseeable loss or damage caused by our goods. You are also entitled to have the goods repaired or replaced if the goods fail to be of acceptable quality and the failure does not amount to a major failure. If you require assistance please call ASRock Tel : +886-2-28965588 ext.123 (Standard International call charges apply)

The terms HDMI™ and HDMI High-Definition Multimedia Interface, and the HDMI logo are trademarks or registered trademarks of HDMI Licensing LLC in the United States and other countries.



# Motherboard Layout

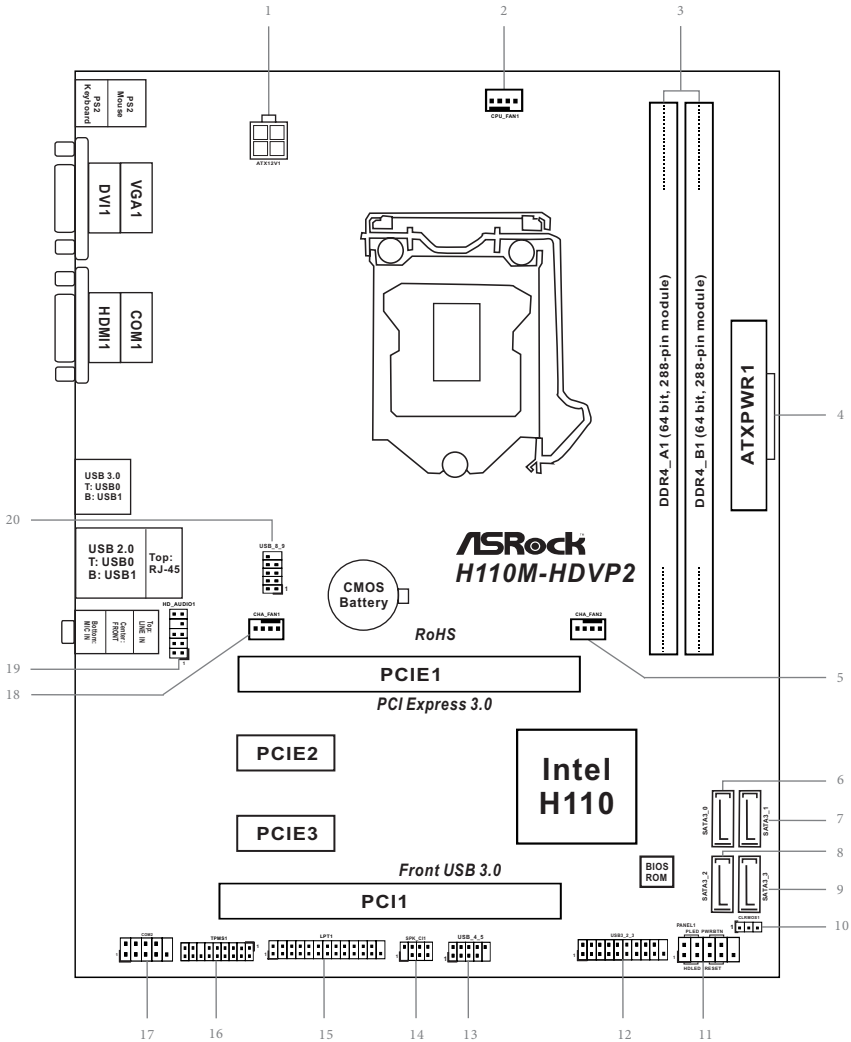

No.	Description
1	ATX 12V Power Connector (ATX12V1)
2	CPU Fan Connector (CPU_FAN1)
3	2 x 288-pin DDR4 DIMM Slots (DDR4_A1, DDR4_B1)
4	ATX Power Connector (ATXPWR1)
5	Chassis Fan Connector (CHA_FAN2)
6	SATA3 Connector (SATA3_0)
7	SATA3 Connector (SATA3_1)
8	SATA3 Connector (SATA3_2)
9	SATA3 Connector (SATA3_3)
10	Clear CMOS Jumper (CLRMOS1)
11	System Panel Header (PANEL1)
12	USB 3.0 Header (USB3_2_3)
13	USB 2.0 Header (USB_4_5)
14	Chassis Intrusion and Speaker Header (SPK_CI1)
15	Print Port Header (LPT1)
16	TPM Header (TPMS1)
17	COM Port Header (COM2)
18	Chassis Fan Connector (CHA_FAN1)
19	Front Panel Audio Header (HD_AUDIO1)
20	USB 2.0 Header (USB_8_9)

## I/O Panel

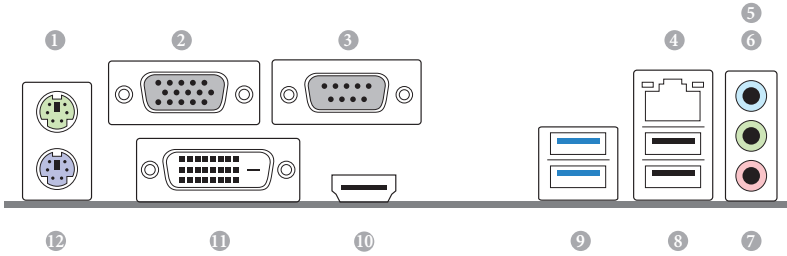

No.	Description	No.	Description
1	PS/2 Mouse Port	7	Microphone (Pink)**
2	D-Sub Port	8	USB 2.0 Ports (USB_01)
3	COM Port	9	USB 3.0 Ports (USB3_01)
4	LAN RJ-45 Port*	10	HDMI Port
5	Line In (Light Blue)**	11	DVI-D Port
6	Front Speaker (Lime)**	12	PS/2 Keyboard Port

\* There are two LEDs on the LAN port. Please refer to the table below for the LAN port LED indications.

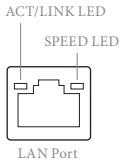

Activity / Link LED		Speed LED	
Status	Description	Status	Description
Off	No Link	Off	10Mbps connection
Blinking	Data Activity	Orange	100Mbps connection
On	Link	Green	1Gbps connection

\*\* To configure 7.1 CH HD Audio, it is required to use an HD front panel audio module and enable the multi-channel audio feature through the audio driver.

Please set Speaker Configuration to "7.1 Speaker" in the Realtek HD Audio Manager.



Function of the Audio Ports in 7.1-channel Configuration:

Port	Function
Light Blue (Rear panel)	Rear Speaker Out
Lime (Rear panel)	Front Speaker Out
Pink (Rear panel)	Central /Subwoofer Speaker Out
Lime (Front panel)	Side Speaker Out

# Chapter 1 Introduction

Thank you for purchasing ASRock H110M-HDVP2 motherboard, a reliable motherboard produced under ASRock's consistently stringent quality control. It delivers excellent performance with robust design conforming to ASRock's commitment to quality and endurance.



*Because the motherboard specifications and the BIOS software might be updated, the content of this documentation will be subject to change without notice. In case any modifications of this documentation occur, the updated version will be available on ASRock's website without further notice. If you require technical support related to this motherboard, please visit our website for specific information about the model you are using. You may find the latest VGA cards and CPU support list on ASRock's website as well. ASRock website <http://www.asrock.com>.*

## 1.1 Package Contents

- ASRock H110M-HDVP2 Motherboard (Micro ATX Form Factor)
- ASRock H110M-HDVP2 Quick Installation Guide
- ASRock H110M-HDVP2 Support CD
- 2 x Serial ATA (SATA) Data Cables (Optional)
- 1 x I/O Panel Shield

## 1.2 Specifications

- Platform**
- Micro ATX Form Factor
  - Solid Capacitor design

- CPU**
- Supports 6<sup>th</sup> Generation Intel® Core™ i7/i5/i3/Pentium®/Celeron® Processors (Socket 1151)
  - Supports CPU up to 95W
  - Digi Power design
  - 4 Power Phase design
  - Supports Intel® Turbo Boost 2.0 Technology

- Chipset**
- Intel® H110

- Memory**
- Dual Channel DDR4 Memory Technology
  - 2 x DDR4 DIMM Slots
  - Supports DDR4 2133 non-ECC, un-buffered memory
  - Supports ECC UDIMM memory modules (operate in non-ECC mode)
  - Max. capacity of system memory: 32GB
  - Supports Intel® Extreme Memory Profile (XMP) 2.0

- Expansion Slot**
- 1 x PCI Express 3.0 x16 Slot (PCIe1: x16 mode)\*
  - \* Supports NVMe SSD as boot disks
  - 2 x PCI Express 2.0 x1 Slots
  - 1 x PCI Slot

- Graphics**
- Intel® HD Graphics Built-in Visuals and the VGA outputs can be supported only with processors which are GPU integrated.
  - Supports Intel® HD Graphics Built-in Visuals : Intel® Quick Sync Video with AVC, MVC (S3D) and MPEG-2 Full HW Encode1, Intel® InTru™ 3D, Intel® Clear Video HD Technology, Intel® Insider™, Intel® HD Graphics 510/530
  - Pixel Shader 5.0, DirectX 12
  - Max. shared memory 1024MB
- \* The size of maximum shared memory may vary from different operating systems.



- Three graphics output options: D-Sub, DVI-D and HDMI
- \* Supports up to 2 displays simultaneously
- Supports HDMI with max. resolution up to 4K x 2K (4096x2160) @ 24Hz / (3840x2160) @ 30Hz
- Supports DVI-D with max. resolution up to 1920x1200 @ 60Hz
- Supports D-Sub with max. resolution up to 1920x1200 @ 60Hz
- Supports Auto Lip Sync, Deep Color (12bpc), xvYCC and HBR (High Bit Rate Audio) with HDMI Port (Compliant HDMI monitor is required)
- Supports Accelerated Media Codecs: HEVC, VP8, VP9
- Supports HDCP with DVI-D and HDMI Ports
- Supports Full HD 1080p Blu-ray (BD) playback with DVI-D and HDMI Ports

### Audio

- 7.1 CH HD Audio (Realtek ALC887 Audio Codec)
- \* To configure 7.1 CH HD Audio, it is required to use an HD front panel audio module and enable the multi-channel audio feature through the audio driver.
- Supports Surge Protection (ASRock Full Spike Protection)
- ELNA Audio Caps

### LAN

- PCIE x1 Gigabit LAN 10/100/1000 Mb/s
- Realtek RTL8111E
- Supports Wake-On-LAN
- Supports Lightning/ESD Protection (ASRock Full Spike Protection)
- Supports LAN Cable Detection
- Supports Energy Efficient Ethernet 802.3az
- Supports PXE

### Rear Panel I/O

- 1 x PS/2 Mouse Port
- 1 x PS/2 Keyboard Port
- 1 x Serial Port: COM1
- 1 x D-Sub Port
- 1 x DVI-D Port
- 1 x HDMI Port
- 2 x USB 2.0 Ports (Supports ESD Protection (ASRock Full Spike Protection))

- 2 x USB 3.0 Ports (Supports ESD Protection (ASRock Full Spike Protection))
- 1 x RJ-45 LAN Port with LED (ACT/LINK LED and SPEED LED)
- HD Audio Jacks: Line in / Front Speaker / Microphone

#### **Storage**

- 4 x SATA3 6.0 Gb/s Connectors, support NCQ, AHCI and Hot Plug

#### **Connector**

- 1 x Print Port Header
- 1 x COM Port Header
- 1 x TPM Header
- 1 x Chassis Intrusion and Speaker Header
- 1 x CPU Fan Connector (4-pin)
- 2 x Chassis Fan Connectors (4-pin)

\* The CPU Fan Connector supports the CPU fan of maximum 1A (12W) fan power.

- 1 x 24 pin ATX Power Connector
- 1 x 4 pin 12V Power Connector
- 1 x Front Panel Audio Connector
- 2 x USB 2.0 Headers (Support 4 USB 2.0 ports) (Supports ESD Protection (ASRock Full Spike Protection))
- 1 x USB 3.0 Header (Supports 2 USB 3.0 ports) (Supports ESD Protection (ASRock Full Spike Protection))

#### **BIOS Feature**

- AMI UEFI Legal BIOS with multilingual GUI support
- ACPI 5.0 Compliant wake up events
- SMBIOS 2.7 Support
- CPU, GT\_CPU, DRAM, PCH 1.0V Voltage Multi-adjustment

#### **Hardware Monitor**

- CPU/Chassis temperature sensing
- CPU/Chassis Fan Tachometer
- CPU/Chassis Quiet Fan (Auto adjust chassis fan speed by CPU temperature)
- CPU/Chassis Fan multi-speed control
- CASE OPEN detection
- Voltage monitoring: +12V, +5V, +3.3V, CPU Vcore

**OS**

- Microsoft® Windows® 10 64-bit / 8.1 64-bit / 7 32-bit / 7 64-bit

\* To install Windows® 7 OS, a modified installation disk with xHCI drivers packed into the ISO file is required. Please refer to page 33 for more detailed instructions.

\* For the updated Windows® 10 driver, please visit ASRock's website for details: <http://www.asrock.com>

**Certifications**

- FCC, CE, WHQL
- ErP/EuP Ready (ErP/EuP ready power supply is required)

\* For detailed product information, please visit our website: <http://www.asrock.com>



*Please realize that there is a certain risk involved with overclocking, including adjusting the setting in the BIOS, applying Untied Overclocking Technology, or using third-party overclocking tools. Overclocking may affect your system's stability, or even cause damage to the components and devices of your system. It should be done at your own risk and expense. We are not responsible for possible damage caused by overclocking.*

---

## Chapter 2 Installation

This is a Micro ATX form factor motherboard. Before you install the motherboard, study the configuration of your chassis to ensure that the motherboard fits into it.

### Pre-installation Precautions

Take note of the following precautions before you install motherboard components or change any motherboard settings.

- Make sure to unplug the power cord before installing or removing the motherboard components. Failure to do so may cause physical injuries and damages to motherboard components.
- In order to avoid damage from static electricity to the motherboard's components, NEVER place your motherboard directly on a carpet. Also remember to use a grounded wrist strap or touch a safety grounded object before you handle the components.
- Hold components by the edges and do not touch the ICs.
- Whenever you uninstall any components, place them on a grounded anti-static pad or in the bag that comes with the components.
- When placing screws to secure the motherboard to the chassis, please do not over-tighten the screws! Doing so may damage the motherboard.

## 2.1 Installing the CPU



1. Before you insert the 1151-Pin CPU into the socket, please check if the **PnP cap** is on the socket, if the CPU surface is unclean, or if there are any **bent pins** in the socket. Do not force to insert the CPU into the socket if above situation is found. Otherwise, the CPU will be seriously damaged.
2. Unplug all power cables before installing the CPU.

1

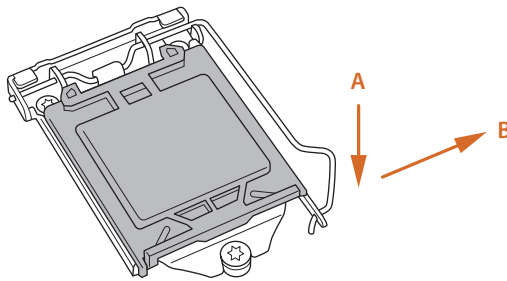

2

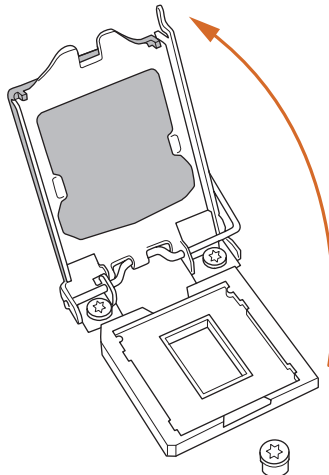

3

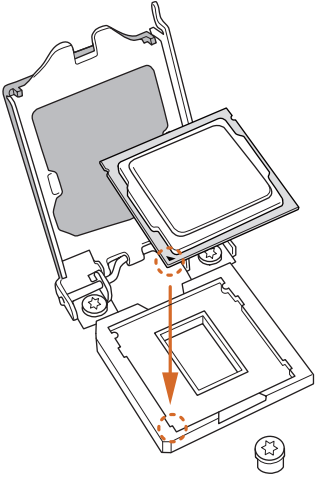

4

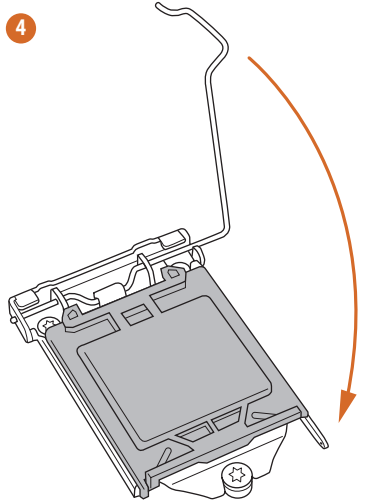

5

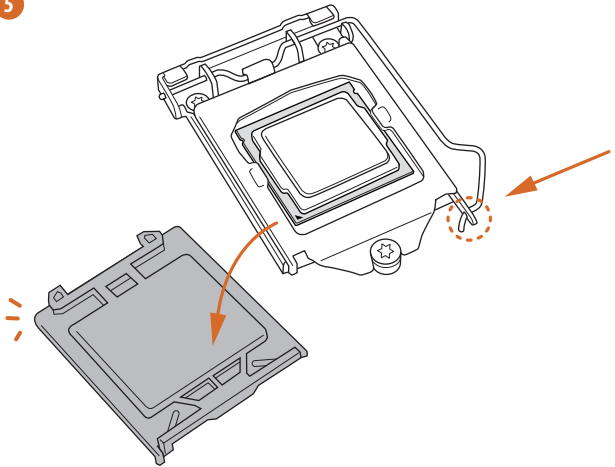



*Please save and replace the cover if the processor is removed. The cover must be placed if you wish to return the motherboard for after service.*

## 2.2 Installing the CPU Fan and Heatsink

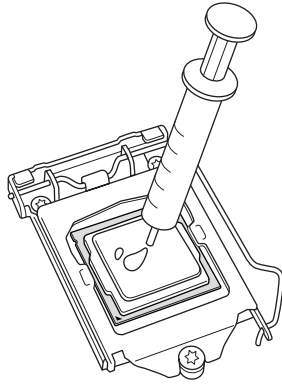

1

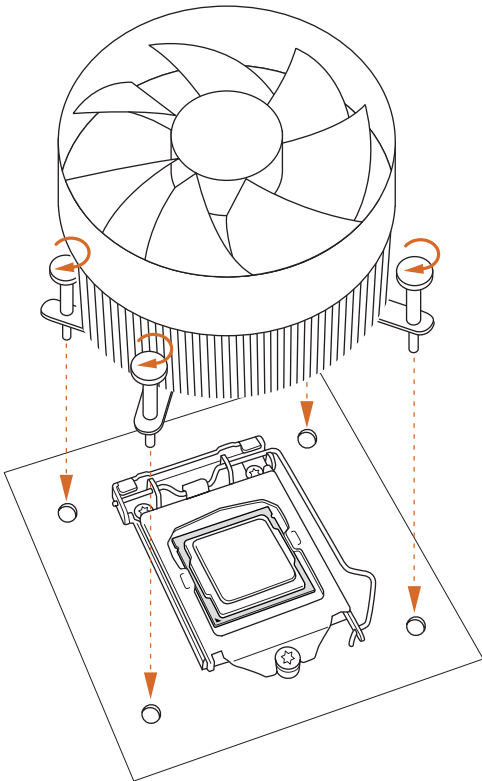

2

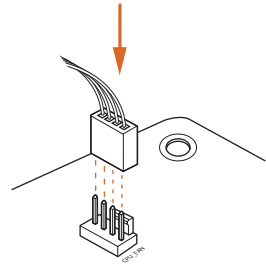



## 2.3 Installing Memory Modules (DIMM)

This motherboard provides two 288-pin DDR4 (Double Data Rate 4) DIMM slots, and supports Dual Channel Memory Technology.



1. For dual channel configuration, you always need to install identical (the same brand, speed, size and chip-type) DDR4 DIMM pairs.
2. It is unable to activate Dual Channel Memory Technology with only one memory module installed.
3. It is not allowed to install a DDR, DDR2 or DDR3 memory module into a DDR4 slot; otherwise, this motherboard and DIMM may be damaged.



*The DIMM only fits in one correct orientation. It will cause permanent damage to the motherboard and the DIMM if you force the DIMM into the slot at incorrect orientation.*

1

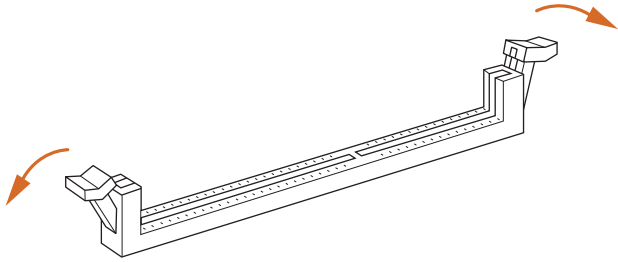

2

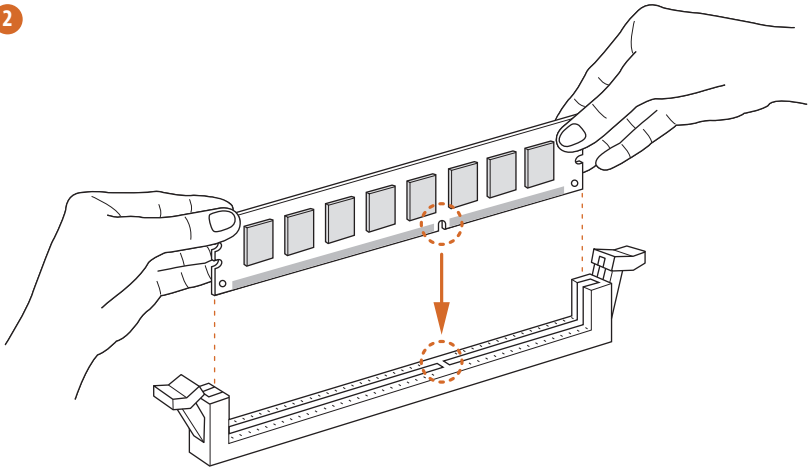

3

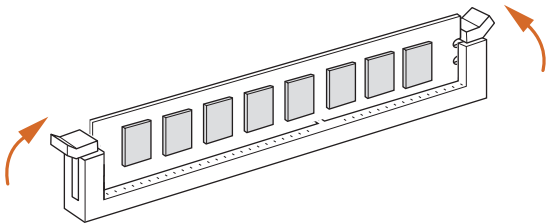

## 2.4 Expansion Slots (PCI and PCI Express Slots)

There is 1 PCI slot and 3 PCI Express slots on the motherboard.



*Before installing an expansion card, please make sure that the power supply is switched off or the power cord is unplugged. Please read the documentation of the expansion card and make necessary hardware settings for the card before you start the installation.*

### **PCI slot:**

The PCI1 slot is used to install expansion cards that have 32-bit PCI interface.

### **PCIe slots:**

PCIE1 (PCIe 3.0 x16 slot) is used for PCI Express x16 lane width graphics cards.

PCIE2 (PCIe 2.0 x1 slot) is used for PCI Express x1 lane width cards.

PCIE3 (PCIe 2.0 x1 slot) is used for PCI Express x1 lane width cards.

## 2.5 Jumpers Setup

The illustration shows how jumpers are setup. When the jumper cap is placed on the pins, the jumper is “Short”. If no jumper cap is placed on the pins, the jumper is “Open”. The illustration shows a 3-pin jumper whose pin1 and pin2 are “Short” when a jumper cap is placed on these 2 pins.

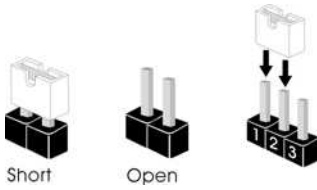

Clear CMOS Jumper  
(CLRMOSE1)  
(see p.1, No. 10)



Default

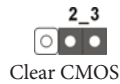

Clear CMOS

CLRMOSE1 allows you to clear the data in CMOS. To clear and reset the system parameters to default setup, please turn off the computer and unplug the power cord from the power supply. After waiting for 15 seconds, use a jumper cap to short pin2 and pin3 on CLRMOSE1 for 5 seconds. However, please do not clear the CMOS right after you update the BIOS. If you need to clear the CMOS when you just finish updating the BIOS, you must boot up the system first, and then shut it down before you do the clear-CMOS action. Please be noted that the password, date, time, and user default profile will be cleared only if the CMOS battery is removed.



*If you clear the CMOS, the case open may be detected. Please adjust the BIOS option “Clear Status” to clear the record of previous chassis intrusion status.*

## 2.6 Onboard Headers and Connectors



Onboard headers and connectors are **NOT** jumpers. Do **NOT** place jumper caps over these headers and connectors. Placing jumper caps over the headers and connectors will cause permanent damage to the motherboard.

System Panel Header  
(9-pin PANEL1)  
(see p.1, No. 11)

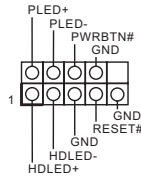

Connect the power switch, reset switch and system status indicator on the chassis to this header according to the pin assignments below. Note the positive and negative pins before connecting the cables.



**PWRBTN (Power Switch):**

Connect to the power switch on the chassis front panel. You may configure the way to turn off your system using the power switch.

**RESET (Reset Switch):**

Connect to the reset switch on the chassis front panel. Press the reset switch to restart the computer if the computer freezes and fails to perform a normal restart.

**PLED (System Power LED):**

Connect to the power status indicator on the chassis front panel. The LED is on when the system is operating. The LED keeps blinking when the system is in S1/S3 sleep state. The LED is off when the system is in S4 sleep state or powered off (S5).

**HDLED (Hard Drive Activity LED):**

Connect to the hard drive activity LED on the chassis front panel. The LED is on when the hard drive is reading or writing data.

The front panel design may differ by chassis. A front panel module mainly consists of power switch, reset switch, power LED, hard drive activity LED, speaker and etc. When connecting your chassis front panel module to this header, make sure the wire assignments and the pin assignments are matched correctly.

Chassis Intrusion and  
Speaker Header  
(7-pin SPK\_CI1)  
(see p.1, No. 14)

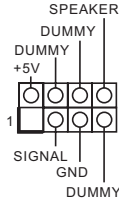

Please connect the  
chassis intrusion and the  
chassis speaker to this  
header.

Serial ATA3 Connectors  
(SATA3\_0:  
see p.1, No. 6)  
(SATA3\_1:  
see p.1, No. 7)  
(SATA3\_2:  
see p.1, No. 8)  
(SATA3\_3:  
see p.1, No. 9)



These four SATA3  
connectors support SATA  
data cables for internal  
storage devices with up to  
6.0 Gb/s data transfer rate.

USB 2.0 Headers  
(9-pin USB\_4\_5)  
(see p.1, No. 13)

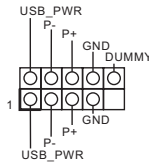

There are two headers  
on this motherboard.  
Each USB 2.0 header can  
support two ports.

(9-pin USB\_8\_9)  
(see p.1, No. 20)

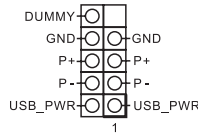

USB 3.0 Header  
(19-pin USB3\_2\_3)  
(see p.1, No. 12)

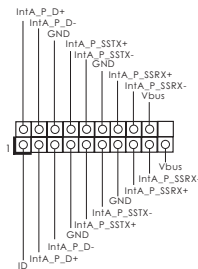

Besides two USB 3.0 ports  
on the I/O panel, there  
is one header on this  
motherboard. Each USB  
3.0 header can support  
two ports.

Front Panel Audio Header  
(9-pin HD\_AUDIO1)  
(see p.1, No. 19)

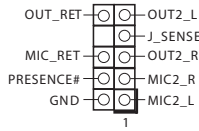

This header is for connecting audio devices to the front audio panel.



- High Definition Audio supports Jack Sensing, but the panel wire on the chassis must support HDA to function correctly. Please follow the instructions in our manual and chassis manual to install your system.
- If you use an AC'97 audio panel, please install it to the front panel audio header by the steps below:
  - Connect Mic\_IN (MIC) to MIC2\_L.
  - Connect Audio\_R (RIN) to OUT2\_R and Audio\_L (LIN) to OUT2\_L.
  - Connect Ground (GND) to Ground (GND).
  - MIC\_RET and OUT\_RET are for the HD audio panel only. You don't need to connect them for the AC'97 audio panel.
  - To activate the front mic, go to the "FrontMic" Tab in the Realtek Control panel and adjust "Recording Volume".

Chassis Fan Connectors  
(4-pin CHA\_FAN1)  
(see p.1, No. 18)

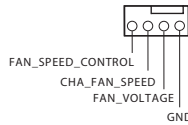

Please connect fan cables to the fan connector and match the black wire to the ground pin.

(4-pin CHA\_FAN2)  
(see p.1, No. 5)

CPU Fan Connector  
(4-pin CPU\_FAN1)  
(see p.1, No. 2)

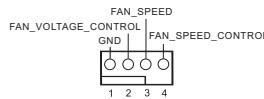

This motherboard provides a 4-Pin CPU fan (Quiet Fan) connector. If you plan to connect a 3-Pin CPU fan, please connect it to Pin 1-3.

ATX Power Connector  
(24-pin ATXPWR1)  
(see p.1, No. 4)

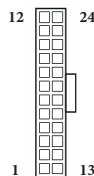

This motherboard provides a 24-pin ATX power connector. To use a 20-pin ATX power supply, please plug it along Pin 1 and Pin 13.

ATX 12V Power Connector  
(4-pin ATX12V1)  
(see p.1, No. 1)



This motherboard provides an 4-pin ATX 12V power connector.

Serial Port Header  
(9-pin COM2)  
(see p.1, No. 17)

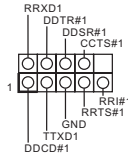

This COM2 header supports a serial port module.

TPM Header  
(17-pin TPMS1)  
(see p.1, No. 16)

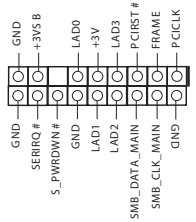

This connector supports Trusted Platform Module (TPM) system, which can securely store keys, digital certificates, passwords, and data. A TPM system also helps enhance network security, protects digital identities, and ensures platform integrity.

Print Port Header  
(25-pin LPT1)  
(see p.1, No. 15)

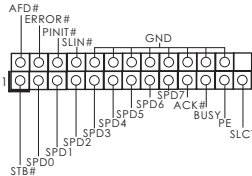

This is an interface for print port cable that allows convenient connection of printer devices.



# 1 개요

ASRock H110M-HDVP2 마더보드를 구입해 주셔서 감사합니다. 이 마더보드는 ASRock의 일관되고 엄격한 품질관리 하에 생산되어 신뢰성이 우수하며, 품질과 내구성에 대한 ASRock의 기준에 부합하는 우수한 성능과 견고한 설계를 제공합니다.



마더보드 규격과 BIOS 소프트웨어를 업데이트할 수도 있기 때문에, 이 문서의 내용은 예고 없이 변경될 수 있습니다. 이 설명서가 변경될 경우, 업데이트된 버전은 ASRock의 웹사이트에서 추가 통지 없이 제공됩니다. 이 마더보드와 관련하여 기술적 지원이 필요한 경우, 당사의 웹사이트를 방문하여 사용 중인 모델에 대한 구체적인 정보를 구하십시오. ASRock의 웹사이트에서는 최신 VGA 카드와 CPU 지원 목록도 찾을 수 있습니다. ASRock 웹사이트 <http://www.asrock.com>.

## 1.1 포장 내용물

- ASRock H110M-HDVP2 마더보드 (Micro ATX 폼팩터)
- ASRock H110M-HDVP2 간편 설치 안내서
- ASRock H110M-HDVP2 지원 CD
- 시리얼 ATA (SATA) 데이터 케이블 2 개 (선택 품목)
- I/O 패널 실드 1 개

## 1.2 규격

- 플랫폼
- Micro ATX 폼 팩터
  - 솔리드 콘덴서 구조

- CPU**
- 6 세대 Intel® Core™ i7/i5/i3/Pentium®/Celeron® 프로세서 (소켓 1151) 지원
  - 최대 95W 까지 CPU 지원
  - Digi Power design
  - 4 개 전원 위상 구조
  - Intel® Turbo Boost 2.0 기술 지원

- 칩세트
- Intel® H110

- 메모리
- 듀얼 채널 DDR4 메모리 기술
  - DDR4 DIMM 슬롯 2 개
  - DDR4 2133 비 ECC, 비버퍼링 메모리 지원
  - ECC UDIMM 메모리 모듈 지원 (비 -ECC 모드에서 작동)
  - 시스템 메모리 최대 용량 : 32GB
  - Intel® Extreme Memory Profile (XMP) 2.0 지원

- 확장 슬롯
- PCI Express 3.0 x16 슬롯 1 개 (PCIe1:x16 모드)\*
  - \* NVMe SSD 를 부팅 디스크로 사용 가능하도록 지원
  - PCI Express 2.0 x1 슬롯 2 개
  - PCI 슬롯 1 개

- 그래픽
- Intel® HD 그래픽스 빌트 - 인 비주얼과 VGA 출력은 GPU 통합 프로세서로만 지원할 수 있습니다.
  - Intel® HD 그래픽스 빌트 - 인 비주얼 지원 : AVC, MVC (S3D) 및 MPEG-2 풀 HW Encode1 지원 Intel® Quick Sync Video, Intel® InTru™ 3D, Intel® 클리어 비디오 HD 기술, Intel® Insider™, Intel® HD 그래픽스 510/530
  - Pixel Shader 5.0, DirectX 12
  - 최대 공유 메모리 1024MB
  - \* 공유된 최대 메모리 크기는 운영 체제에 따라 다를 수 있습니다.
  - VGA 출력 옵션 세 개 : D-Sub, DVI-D 및 HDMI
  - HDMI 지원 (최대 해상도 4K x 2K (4096x2160) @ 24Hz / (3840x2160) @ 30Hz)
  - DVI-D 지원 (최대 해상도 1920x1200 @ 60Hz)

- D-Sub 지원 ( 최대 해상도 1920x1200 @ 60Hz)
- Auto Lip Sync, Deep Color (12bpc), xvYCC 및 HBR (High Bit Rate Audio)(HDMI 포트 포함 ) 지원 (HDMI 호환 모니터 필요 )
- 가속화된 미디어 코덱 지원 : HEVC, VP8, VP9
- DVI-D 및 HDMI 포트를 이용한 HDCP 지원
- DVI-D 및 HDMI 포트를 이용한 Full HD 1080p Blu-ray (BD) 재생 지원

**오디오**

- 7.1 CH HD 오디오 (Realtek ALC887 오디오 코덱 )
- \* 7.1 CH HD 오디오를 구성하려면 HD 전면 패널 오디오 모듈을 사용하고 다채널 오디오 기능을 오디오 드라이버로 활성화해야 합니다 .
- 서지 보호 지원 (ASRock 풀 스파이크 보호 )
- ELNA 오디오 캡

**LAN**

- PCIE 1 개 , Gigabit LAN 10/100/1000 Mb/s
- Realtek RTL811E
- Wake-On-LAN 지원
- 번개 /ESD 보호 지원 (ASRock 풀 스파이크 보호 )
- LAN 케이블 감지 지원
- 절전형 이더넷 802.3az 지원
- PXE 지원

**후면 패널  
I/O**

- PS/2 마우스 포트 1 개
- PS/2 키보드 포트 1 개
- 의 COM1 1 개
- D-Sub 포트 1 개
- DVI-D 포트 1 개
- HDMI 포트 1 개
- USB 2.0 포트 2 개 (ESD 보호 지원 (ASRock 풀 스파이크 보호 ))
- USB 3.0 포트 2 개 (ESD 보호 지원 (ASRock 풀 스파이크 보호 ))
- LED 장착 RJ-45 LAN 포트 1 개 (ACT/LINK LED 및 SPEED LED)
- HD 오디오 잭 : 라인 입력 / 전면 스피커 / 마이크

- 저장 장치
- SATA3 6.0 Gb/s 커넥터 4 개 , NCQ, AHCI 및 “핫 플러그” 지원

- 커넥터
- 인쇄 포트 헤더 1 개
  - COM 포트 헤더 1 개
  - TPM 헤더 1 개
  - 새시 침입 및 스피커 헤더 1 개
  - CPU 팬 커넥터 (4 핀 ) 1 개
  - 새시 팬 커넥터 (4 핀 ) 1 개
- \* CPU 팬 커넥터는 팬 출력이 최대 1A(12W) 인 CPU 팬을 지원 합니다 .
- 24 핀 ATX 전원 커넥터 1 개
  - 4 핀 12V 전원 커넥터 1 개
  - 전면 패널 오디오 커넥터 1 개
  - USB 2.0 헤더 2 개 (USB 2.0 포트 4 개 지원 )(ESD 보호 지원 (ASRock 폴 스파이크 보호 ))
  - USB 3.0 헤더 1 개 (USB 3.0 포트 2 개 지원 )(ESD 보호 지원 (ASRock 폴 스파이크 보호 ))

- BIOS 기능
- 다국어 GUI 지원을 제공하는 AMI UEFI 적합형 BIOS
  - ACPI 5.0 준수 웨이크 업 이벤트
  - SMBIOS 2.7 지원
  - CPU, GT\_CPU, DRAM, PCH 1.0V 전압 다중 조정

- 하드웨어 모니터
- CPU/ 새시 온도 감지
  - CPU/ 새시 팬 타코미터
  - CPU/ 새시 저소음 팬 (CPU 온도에 의한 새시 팬 속도 자동 조절 )
  - CPU/ 새시 팬 다중 속도 조절
  - 케이스 열림 감지
  - 전압 모니터링 : +12V, +5V, +3.3V, CPU Vcore

- OS
- Microsoft® Windows® 10 64 비트 / 8.1 64 비트 / 7 32 비트 / 7 64 비트
- \* Windows® 7 OS 를 설치하려면 , xHCI 드라이버를 ISO 파일에 포함시킨 수정된 설치 디스크가 필요합니다 . 자세한 사용법은 33 페이지를 참조하십시오 .
- \* 업데이트된 Windows® 10 드라이브의 자세한 내용은 다음의 ASRock 웹사이트를 참조하십시오 .<http://www.asrock.com>

## 인증

- FCC, CE, WHQL
- ErP/EuP 사용 가능 (ErP/EuP 사용 가능 전원공급장치 필요)

\* 자세한 제품 정보에 대해서는 당사 웹사이트를 참조하십시오 : <http://www.asrock.com>



BIOS 설정을 조정하거나 *Untied Overclocking Technology* 를 적용하거나 타업체의 오버클로킹 도구를 사용하는 것을 포함하는 오버클로킹에는 어느 정도의 위험이 따른다는 것을 유념하십시오. 오버클로킹은 시스템 안정성에 영향을 주거나 심지어 시스템의 구성 요소와 장치에 손상을 입힐 수도 있습니다. 오버클로킹은 사용자 스스로 위험과 비용을 감수하고 해야 합니다. 당사는 오버클로킹에 의해 발생할 수 있는 손상에 대해서 책임이 없습니다.

### 1.3 점퍼 설정

그림은 점퍼를 어떻게 설정하는지 보여줍니다. 점퍼 캡을 핀에 씌우면 점퍼가 “단락” 됩니다. 점퍼 캡을 핀에 씌우지 않으면 점퍼가 “단선”됩니다. 그림은 3 핀 점퍼를 보여주며 핀 1 과 핀 2 는 점퍼 캡을 씌울 때 “단락”됩니다.

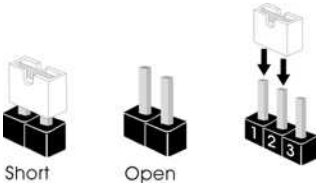

Clear CMOS 점퍼  
(CLRMO51)

(1 페이지, 10 번 항목 참조)



기본값



Clear CMOS

CLRMO51 을 사용하여 CMOS 에 저장된 데이터를 지울 수 있습니다. 시스템 파라미터를 지우고 기본 설정으로 초기화하려면 컴퓨터를 끄고 전원 코드를 전원공급장치에서 빼십시오. 15 초 동안 기다린 후 점퍼 캡을 사용하여 CLRMO51 의 핀 2 와 핀 3 을 5 초 동안 단락시키십시오. 그러나 BIOS 업데이트 직후에는 CMOS 를 삭제하지 마십시오. BIOS 업데이트를 완료한 직후 CMOS 를 지워야 할 경우, 우선 시스템을 부팅한 후 바이오스 업데이트를 종료한 다음 CMOS 지우기 작업을 해야 합니다. CMOS 배터리를 제거할 경우에만 암호, 날짜, 시간, 사용자 기본 프로파일이 지워집니다.



CMOS 를 지울 경우 케이스 열림이 감지될 수도 있습니다. BIOS 옵션 “Clear Status( 상태 지우기)”를 조절하여 이전의 새시 침입 상태에 대한 기록을 지우십시오.

## 1.4 온보드 헤더 및 커넥터



온보드 헤더와 커넥터는 점퍼가 아닙니다. 점퍼 캡을 온보드 헤더와 커넥터에 씌우지 마십시오. 점퍼 캡을 온보드 헤더와 커넥터에 씌우면 마더보드가 영구적으로 손상됩니다.

시스템 패널 헤더

(9 핀 PANEL1)

(1 페이지, 11 번 항목 참조)

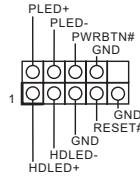

새시의 전원 스위치, 리셋 스위치, 시스템 상태 표시등을 아래의 핀 할당에 따라 이 헤더에 연결합니다. 케이블을 연결하기 전에 양극 핀과 음극 핀을 기록합니다.



**PWRBTN( 전원 스위치):**

새시 전면 패널의 전원 스위치에 연결합니다. 전원 스위치를 이용해 시스템을 끄는 방법을 구성할 수 있습니다.

**RESET( 리셋 스위치):**

새시 전면 패널의 리셋 스위치에 연결합니다. 컴퓨터가 정지하고 정상적 재시작을 수행하지 못할 경우 리셋 스위치를 눌러 컴퓨터를 재시작합니다.

**PLED( 시스템 전원 LED):**

새시 전면 패널의 전원 상태 표시등에 연결합니다. 시스템이 작동하고 있을 때는 LED 가 켜져 있습니다. 시스템이 S1/S3 대기 상태에 있을 때는 LED 가 계속 깜박입니다. 시스템이 S4 대기 상태 또는 전원 꺼짐 (S5) 상태에 있을 때는 LED 가 꺼져 있습니다.

**HDLED( 하드 드라이브 동작 LED):**

새시 전면 패널의 하드 드라이브 동작 LED 에 연결합니다. 하드 드라이브가 데이터를 읽거나 쓰고 있을 때 LED 가 켜져 있습니다.

전면 패널 디자인은 새시별로 다를 수 있습니다. 전면 패널 모듈은 주로 전원 스위치, 리셋 스위치, 전원 LED, 하드 드라이브 동작 LED, 스피커 등으로 구성되어 있습니다. 새시 전면 패널 모듈을 이 헤더에 연결할 때 와이어 할당과 핀 할당이 정확히 일치하는지 확인합니다.

새시 침입 및 스피커 헤더  
(7 핀 SPK\_CI1)  
(1 페이지, 14 번 항목 참조)

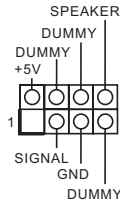

새시 침입 및 새시 스피커를 이 헤더에 연결하십시오.

시리얼 ATA3 커넥터  
(SATA3\_0:  
1 페이지, 6 번 항목 참조)  
(SATA3\_1:  
1 페이지, 7 번 항목 참조)  
(SATA3\_2:  
1 페이지, 8 번 항목 참조)  
(SATA3\_3:  
1 페이지, 9 번 항목 참조)

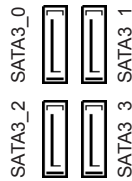

이들 네 개의 SATA3 커넥터는 최대 6.0 Gb/s 데이터 전송 속도를 제공하는 내부 저장 장치용 SATA 데이터 케이블을 지원합니다.

USB 2.0 헤더  
(9 핀 USB\_4\_5)  
(1 페이지, 13 번 항목 참조)

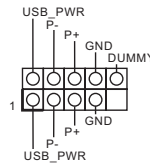

이 마더보드에는 두 개의 헤더가 있습니다. 이 USB 2.0 헤더는 포트 두 개를 지원할 수 있습니다.

(9 핀 USB\_8\_9)  
(1 페이지, 20 번 항목 참조)

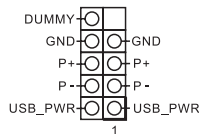

USB 3.0 헤더  
(19 핀 USB3\_2\_3)  
(1 페이지, 12 번 항목 참조)

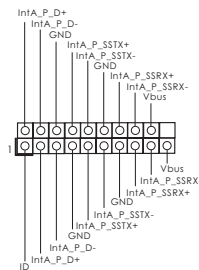

I/O 패널에 USB 3.0 포트 두 개가 탑재되어 있을 뿐 아니라 마더보드에 헤더 한 개가 탑재되어 있습니다. 각 USB 3.0 헤더는 포트 두 개를 지원할 수 있습니다.



전면 패널 오디오 헤더  
(9 핀 HD\_AUDIO1)  
(1 페이지, 19번 항목 참조)

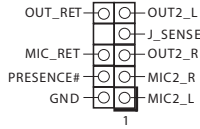

이 헤더는 오디오 장치를 전면 오디오 패널에 연결하는 데 사용됩니다.



1. 고품질 오디오는 잭 감지를 지원하지만 올바르게 작동하려면 새시의 패널 와이어가 HDA를 지원해야 합니다. 설명서 및 새시 설명서에 나와 있는 지침을 따라 시스템을 설치하십시오.
2. AC'97 오디오 패널을 사용할 경우 아래와 같은 절차를 따라 전면 패널 오디오 헤더에 설치하십시오:
  - A. Mic\_IN (MIC)를 MIC2\_L에 연결합니다.
  - B. Audio\_R (RIN)을 OUT2\_R에 연결하고 Audio\_L (LIN)을 OUT2\_L에 연결합니다.
  - C. 접지 (GND)를 접지 (GND)에 연결합니다.
  - D. MIC\_RET 및 OUT\_RET는 HD 오디오 패널에만 사용됩니다. AC'97 오디오 패널용으로 연결할 필요가 없습니다.
  - E. 전면 마이크를 활성화하려면 Realtek 제어판에서 "FrontMic" 탭으로 가서 "Recording Volume(녹음 볼륨)"을 조정합니다.

새시 팬 커넥터  
(4 핀 CHA\_FAN1)  
(1 페이지, 18번 항목 참조)

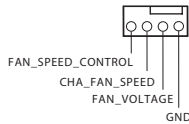

팬 케이블을 팬 커넥터에 연결하고 검은색 와이어를 접지핀에 연결하십시오.

(4 핀 CHA\_FAN2)  
(1 페이지, 5번 항목 참조)

CPU 팬 커넥터  
(4 핀 CPU\_FAN1)  
(1 페이지, 2번 항목 참조)

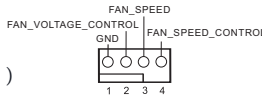

이 마더보드에는 4핀 CPU 팬 (저소음 팬) 커넥터가 탑재되어 있습니다. 3핀 CPU 팬을 연결하려는 경우 핀 1-3에 연결하십시오.

ATX 전원 커넥터  
(24 핀 ATXPWR1)  
(1 페이지, 4번 항목 참조)

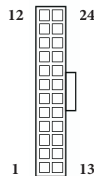

이 마더보드에는 24핀 ATX 전원 커넥터가 탑재되어 있습니다. 20핀 ATX 전원공급장치를 사용하려면 핀 1과 핀 13을 따라 연결하십시오.

ATX 12V 전원 커넥터  
(4 핀 ATX12V1)  
(1 페이지, 1 번 항목 참조)



이 마더보드에는 4 핀 ATX 12V 전원 커넥터가 탑재되어 있습니다.

시리얼 포트 헤더  
(9 핀 COM2)  
(1 페이지, 17 번 항목 참조)

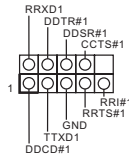

이 COM2 헤더는 시리얼 포트 모듈을 지원합니다.

TPM 헤더  
(17 핀 TPMS1)  
(1 페이지, 16 번 항목 참조)

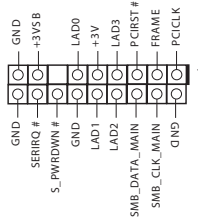

이 커넥터는 키, 디지털 인증서, 암호 및 데이터를 안전하게 보관할 수 있는 TPM(Trusted Platform Module) 시스템을 지원합니다. TPM 시스템은 네트워크 보안을 강화하고, 디지털 신원을 보호하며 플랫폼 무결성을 유지합니다.

인쇄 포트 헤더  
(25 핀 LPT1)  
(1 페이지, 15 번 항목 참조)

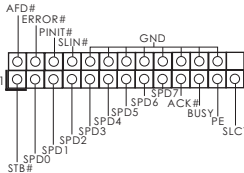

프린터 장치의 간편한 연결을 가능하게 하는 인쇄 포트 케이블용 인터페이스입니다.

## Enabling USB Ports for Windows® 7 Installation

Intel® Braswell and Skylake has removed their support for the Enhanced Host Controller Interface (EHCI – USB2.0) and only kept the eXtensible Host Controller Interface (XHCI – USB3.0). Due to that fact that XHCI is not included in the Windows 7 inbox drivers, users may find it difficult to install Windows 7 operating system because the USB ports on their motherboard won't work. In order for the USB ports to function properly, please create a Windows® 7 installation disk with the Intel® USB 3.0 eXtensible Host Controller (xHCI) drivers packed into the ISO file.

### Requirements

- A Windows® 7 installation disk or USB drive
- USB 3.0 drivers (included in the ASRock Support CD or website)
- A Windows® PC
- Win7 USB Patcher (included in the ASRock Support CD or website)

### Scenarios

#### **You have an ODD and PS/2 ports:**

If there is an optical disc drive, PS/2 ports and PS/2 Keyboard or mouse on your computer, you can skip the instructions below and go ahead to install Windows® 7 OS.

#### **You only have an ODD (For Intel Skylake platforms only):**

If there is an optical disc drive but no PS/2 ports on your computer, please enable the “PS/2 Simulator” option in *UEFI SETUP UTILITY > Advanced > USB Configuration*, which allows the USB port to function as a PS/2 port, and then you can install the Windows® 7 OS. Please set PS/S Simulator back to disabled after the installation.

#### **You've got nothing:**

If you do not have an optical disc drive, please find another computer and follow the instructions below to create a new ISO file with the “Win7 USB Patcher”. Then use the new patched Windows® 7 installation USB drive to install Windows® 7 OS.

## Instructions

### Step 1

Insert the Windows® 7 installation disk or USB drive to your system.

### Step 2

Extract the tool (Win7 USB Patcher) and launch it.

### Step 3

Select the “Win7 Folder” from Step1 by clicking the red circle as shown as the picture below.



### Step 4

Select the “USB Driver Folder” by clicking the red circle as shown as the picture below.



If you are using ASRock’s Support CD for the USB 3.0 driver, please select your CD-ROM.

**Step 5**

Select where to save the ISO file by pressing the red circle as shown as the picture below.

**Step 6**

If you want to burn the patched image to a CD, please check “Burn Image” and select “Target Device to Burn”. If not, the patched ISO image will be exported to the destination selected in Step5. Then Press “Start” to proceed.

**Step 7**

Now you are able to install Windows® 7 on Braswell or Skylake with the new burned CD. Or please use the patched ISO image to make an OS USB drive to install the OS.

## Contact Information

If you need to contact ASRock or want to know more about ASRock, you're welcome to visit ASRock's website at <http://www.asrock.com>; or you may contact your dealer for further information. For technical questions, please submit a support request form at <http://www.asrock.com/support/tsd.asp>

### **ASRock Incorporation**

2F., No.37, Sec. 2, Jhongyang S. Rd., Beitou District,

Taipei City 112, Taiwan (R.O.C.)

### **ASRock EUROPE B.V.**

Bijsterhuizen 11-11

6546 AR Nijmegen

The Netherlands

Phone: +31-24-345-44-33

Fax: +31-24-345-44-38

### **ASRock America, Inc.**

13848 Magnolia Ave, Chino, CA91710

U.S.A.

Phone: +1-909-590-8308

Fax: +1-909-590-1026



## EC-Declaration of Conformity

For the following equipment:

**Motherboard**

(Product Name)

**H110M-HDVP2 / ASRock**

(Model Designation / Trade Name)

**ASRock Incorporation**

(Manufacturer Name)

**2F, No.37, Sec. 2, Zhongyang S. Rd., Beitou District, Taipei City 112, Taiwan (R.O.C.)**

(Manufacturer Address)

is herewith confirmed to comply with the requirements set out in the Council Directive on the Approximation of the Laws of the Member States relating to Electromagnetic Compatibility Directive (2004/108/EC) and Safety Directive (2006/95/EC), the following standards are applied:

- EN 55022: 2006+A1:2007
- EN 61000-3-2: 2009
- EN 61000-3-3: 2008
- EN 55024: 1998 + A1:2001 + A2:2003
  - IEC 61000-4-2: 2008;
  - IEC 61000-4-3: 2010; IEC 61000-4-4: 2010;
  - IEC 61000-4-5: 2005; IEC 61000-4-6: 2008;
  - IEC 61000-4-8: 2009; IEC 61000-4-11: 2004;
- EN 60950-1: 2005 + A1:2009
  - IEC 60950-1: 2006 + A11:2009 + A1:2010 + A12:2011

The following manufacturer / importer or authorized representative established within the EUT is responsible for this declaration:

**ASRock EUROPE B.V.**

(Company Name)

**Bijsterhuizen 1111 6546 AR Nijmegen The Netherlands**

(Company Address)

Person responsible for making this declaration:

(Name, Surname)

**A.V.P**

(Position / Title)

**Apr. 15, 2016**

(Date)