



K10N78FullHD-hSLI

User Manual

Version 2.0/3.0

Published March 2008

Copyright©2008 ASRock INC. All rights reserved.

Copyright Notice:

No part of this manual may be reproduced, transcribed, transmitted, or translated in any language, in any form or by any means, except duplication of documentation by the purchaser for backup purpose, without written consent of ASRock Inc.

Products and corporate names appearing in this manual may or may not be registered trademarks or copyrights of their respective companies, and are used only for identification or explanation and to the owners' benefit, without intent to infringe.

Disclaimer:

Specifications and information contained in this manual are furnished for informational use only and subject to change without notice, and should not be constructed as a commitment by ASRock. ASRock assumes no responsibility for any errors or omissions that may appear in this manual.

With respect to the contents of this manual, ASRock does not provide warranty of any kind, either expressed or implied, including but not limited to the implied warranties or conditions of merchantability or fitness for a particular purpose.

In no event shall ASRock, its directors, officers, employees, or agents be liable for any indirect, special, incidental, or consequential damages (including damages for loss of profits, loss of business, loss of data, interruption of business and the like), even if ASRock has been advised of the possibility of such damages arising from any defect or error in the manual or product.



This device complies with Part 15 of the FCC Rules. Operation is subject to the following two conditions:

- (1) this device may not cause harmful interference, and
- (2) this device must accept any interference received, including interference that may cause undesired operation.

CALIFORNIA, USA ONLY

The Lithium battery adopted on this motherboard contains Perchlorate, a toxic substance controlled in Perchlorate Best Management Practices (BMP) regulations passed by the California Legislature. When you discard the Lithium battery in California, USA, please follow the related regulations in advance.

"Perchlorate Material-special handling may apply, see www.dtsc.ca.gov/hazardouswaste/perchlorate"

ASRock Website: <http://www.asrock.com>

Contents

1. Introduction	5
1.1 Package Contents	5
1.2 Specifications	6
1.3 Minimum Hardware Requirement Table for Windows® Vista™ Premium 2008 and Basic Logo	10
1.4 Minimum Hardware Requirement for 1080p Blu-ray (BD) / HD-DVD Playback Support	11
1.5 1080p Blu-ray (BD) / HD-DVD Films Which Pass Our Lab Test .	12
1.6 Motherboard Layout (K10N78FullHD-hSLI R2.0)	13
1.7 Motherboard Layout (K10N78FullHD-hSLI R3.0)	14
1.8 ASRock 6CH_DVI I/O Plus	15
2. Installation	16
Pre-installation Precautions	16
2.1 CPU Installation	17
2.2 Installation of CPU Fan and Heatsink	17
2.3 Installation of Memory Modules (DIMM)	18
2.4 Expansion Slots (PCI and PCI Express Slots)	19
2.5 Hybrid SLI™ Operation Guide	21
2.6 Dual Monitor and Surround Display Features	25
2.7 HDMI Audio Function Operation Guide	29
2.8 Jumpers Setup	30
2.9 Onboard Headers and Connectors	31
2.10 HDMI_SPDIF Header Connection Guide	35
2.11 SATAII Hard Disk Setup Guide	36
2.12 Serial ATA (SATA) / Serial ATAII (SATAII) Hard Disks Installation	37
2.13 Hot Plug and Hot Swap Functions for SATA / SATAII HDDs	37
2.14 SATA / SATAII HDD Hot Plug Feature and Operation Guide	38
2.15 Driver Installation Guide	40
2.16 Installing Windows® XP / XP 64-bit / Vista™ / Vista™ 64-bit Without RAID Functions	40
2.16.1 Installing Windows® XP / XP 64-bit Without RAID Functions	40
2.16.2 Installing Windows® Vista™ / Vista™ 64-bit Without RAID Functions	41
2.17 Installing Windows® XP / XP 64-bit / Vista™ / Vista™ 64-bit With RAID Functions	42
2.17.1 Installing Windows® XP / XP 64-bit With RAID Functions	42
2.17.2 Installing Windows® Vista™ / Vista™ 64-bit With RAID Functions	43

2.18	Untied Overclocking Technology	44
3.	BIOS SETUP UTILITY	45
3.1	Introduction	45
3.1.1	BIOS Menu Bar	45
3.1.2	Navigation Keys	46
3.2	Main Screen	46
3.3	Advanced Screen	47
3.3.1	CPU Configuration	47
3.3.2	Chipset Configuration	52
3.3.3	ACPI Configuration	54
3.3.4	IDE Configuration	55
3.3.5	PCI/PnP Configuration	57
3.3.6	Floppy Configuration	58
3.3.7	Super IO Configuration	58
3.3.8	USB Configuration	59
3.4	Hardware Health Event Monitoring Screen	60
3.5	Boot Screen	61
3.5.1	Boot Settings Configuration	61
3.6	Security Screen	62
3.7	Exit Screen	63
4.	Software Support	64
4.1	Install Operating System	64
4.2	Support CD Information	64
4.2.1	Running Support CD	64
4.2.2	Drivers Menu	64
4.2.3	Utilities Menu	64
4.2.4	Contact Information	64

1. Introduction

Thank you for purchasing ASRock **K10N78FullHD-hSLI** motherboard, a reliable motherboard produced under ASRock's consistently stringent quality control. It delivers excellent performance with robust design conforming to ASRock's commitment to quality and endurance.

In this manual, chapter 1 and 2 contain introduction of the motherboard and step-by-step guide to the hardware installation. Chapter 3 and 4 contain the configuration guide to BIOS setup and information of the Support CD.



Because the motherboard specifications and the BIOS software might be updated, the content of this manual will be subject to change without notice. In case any modifications of this manual occur, the updated version will be available on ASRock website without further notice. You may find the latest VGA cards and CPU support lists on ASRock website as well. ASRock website <http://www.asrock.com>
If you require technical support related to this motherboard, please visit our website for specific information about the model you are using.
www.asrock.com/support/index.asp

1.1 Package Contents

- 1 x ASRock **K10N78FullHD-hSLI** Motherboard
(Micro ATX Form Factor: 9.6-in x 9.6-in, 24.4 cm x 24.4 cm)
- 1 x ASRock **K10N78FullHD-hSLI** Quick Installation Guide
- 1 x ASRock **K10N78FullHD-hSLI** Support CD
- 1 x Ultra ATA 66/100/133 IDE Ribbon Cable (80-conductor)
- 1 x 3.5-in Floppy Drive Ribbon Cable
- 1 x Serial ATA (SATA) Data Cable (Optional)
- 1 x Serial ATA (SATA) HDD Power Cable (Optional)
- 1 x HDMI_SPDIF Cable (Optional)
- 1 x "ASRock 6CH_DVI I/O Plus" I/O Shield

1.2 Specifications

Platform	- Micro ATX Form Factor: 9.6-in x 9.6-in, 24.4 cm x 24.4 cm
CPU	- Support for Socket AM2+ / AM2 processors: AMD Phenom™ FX / Phenom / Athlon 64 FX / Athlon 64 X2 Dual-Core / Athlon X2 Dual-Core / Athlon 64 / Sempron processor - AMD LIVE!™ Ready - Supports AMD's Cool 'n' Quiet™ Technology - FSB 2600 MHz (5.2 GT/s) (see CAUTION 1) - Supports Untied Overclocking Technology (see CAUTION 2) - Supports Hyper-Transport 3.0 (HT 3.0) Technology
Chipset	- NVIDIA® GeForce 8200
Memory	- Dual Channel DDR2 Memory Technology (see CAUTION 3) - 4 x DDR2 DIMM slots - Support DDR2 1066/800/667/533 non-ECC, un-buffered memory (see CAUTION 4) - Max. capacity of system memory: 8GB (see CAUTION 5)
Expansion Slot	- 1 x PCI Express 2.0 x16 slot (green @ x16 mode) - 1 x PCI Express x1 slot - 2 x PCI slots - Supports NVIDIA® Hybrid SLI™ (see CAUTION 6)
Graphics	- Integrated NVIDIA® GeForce8 Series - DX10 VGA, Pixel Shader 4.0 - Max. shared memory 512MB (see CAUTION 7) - Dual VGA Output: support DVI-D and D-Sub ports by independent display controllers - Supports HDCP function with DVI-D port - Supports 1080p Blu-ray (BD) / HD-DVD playback with DVI-D port (see CAUTION 8) - NVIDIA® PureVideo™ HD Ready
Audio	- 5.1 CH Windows® Vista™ Premium Level HD Audio (ALC662 Audio Codec) - Chipset embedded HDMI Audio
LAN	- K10N78FullHD-hSLI R2.0 Realtek PHY RTL8201CL, speed 10/100 Mb/s - K10N78FullHD-hSLI R3.0 Realtek Giga PHY RTL8211B, speed 10/100/1000 Mb/s - Supports Wake-On-LAN
Rear Panel I/O	ASRock 6CH_DVI I/O Plus - 1 x PS/2 Mouse Port - 1 x PS/2 Keyboard Port

	<ul style="list-style-type: none"> - 1 x VGA/D-Sub Port - 1 x VGA/DVI-D Port (see CAUTION 9) - 6 x Ready-to-Use USB 2.0 Ports - 1 x RJ-45 Port - HD Audio Jack: Line in/Front Speaker/Microphone
Connector	<ul style="list-style-type: none"> - 6 x Serial ATAII 3.0Gb/s connectors, support RAID (RAID 0, RAID 1, RAID 0+1, RAID 5 and JBOD), NCQ, AHCI and “Hot Plug” functions (see CAUTION 10) - 1 x ATA133 IDE connector (supports 2 x IDE devices) - 1 x Floppy connector - 1 x DeskExpress Hot Plug Detection header - 1 x COM port header - 1 x HDMI_SPDIF header - CPU/Chassis FAN connector - 24 pin ATX power connector - 4 pin 12V power connector - CD in header - Front panel audio header - 2 x USB 2.0 headers (support 4 USB 2.0 ports) (see CAUTION 11) - 1 x WiFi/E header (see CAUTION 12)
BIOS Feature	<ul style="list-style-type: none"> - 4Mb AMI BIOS - AMI Legal BIOS - Supports “Plug and Play” - ACPI 1.1 Compliance Wake Up Events - Supports jumperfree - SMBIOS 2.3.1 Support
Support CD	<ul style="list-style-type: none"> - Drivers, Utilities, AntiVirus Software (Trial Version)
Unique Feature	<ul style="list-style-type: none"> - ASRock OC Tuner (see CAUTION 13) <ul style="list-style-type: none"> - Intelligent Energy Saver (see CAUTION 14) - Hybrid Booster: <ul style="list-style-type: none"> - CPU Frequency Stepless Control (see CAUTION 15) - ASRock U-COP (see CAUTION 16) - Boot Failure Guard (B.F.G.) - ASRock AM2 Boost: ASRock Patented Technology to boost memory performance up to 12.5% (see CAUTION 17)
Hardware Monitor	<ul style="list-style-type: none"> - CPU Temperature Sensing - Chassis Temperature Sensing - CPU Fan Tachometer - Chassis Fan Tachometer - CPU Quiet Fan - Voltage Monitoring: +12V, +5V, +3.3V, Vcore

OS	- Microsoft® Windows® XP / XP Media Center / XP 64-bit / Vista™ / Vista™ 64-bit compliant
Certifications	- FCC, CE, Microsoft® WHQL Certificated

* For detailed product information, please visit our website: <http://www.asrock.com>

WARNING

Please realize that there is a certain risk involved with overclocking, including adjusting the setting in the BIOS, applying Untied Overclocking Technology, or using the third-party overclocking tools. Overclocking may affect your system stability, or even cause damage to the components and devices of your system. It should be done at your own risk and expense. We are not responsible for possible damage caused by overclocking.

CAUTION!

1. If you install AM2 CPU on this motherboard, the system bus speed will be HT1.0 (2000 MT/s). If you install AM2+ CPU on this motherboard, the system bus speed will be HT3.0 (up to 5200 MT/s), and the HT Link frequency depends on the ability of the AM2+ CPU you adopt. Please refer to the CPU support list on our website for more information.
ASRock website <http://www.asrock.com>
2. This motherboard supports Untied Overclocking Technology. Please read "Untied Overclocking Technology" on page 44 for details.
3. This motherboard supports Dual Channel Memory Technology. Before you implement Dual Channel Memory Technology, make sure to read the installation guide of memory modules on page 18 for proper installation.
4. Whether 1066MHz memory speed is supported depends on the AM2+ CPU you adopt. If you want to adopt DDR2 1066 memory module on this motherboard, please refer to the memory support list on our website for the compatible memory modules.
ASRock website <http://www.asrock.com>
5. Due to the operating system limitation, the actual memory size may be less than 4GB for the reservation for system usage under Windows® XP and Windows® Vista™. For Windows® XP 64-bit and Windows® Vista™ 64-bit with 64-bit CPU, there is no such limitation.
6. Hybrid SLI™ feature should depend on the driver from NVIDIA® and it may be updated in the near future. Currently, the Hybrid SLI™ driver in our support CD is beta driver provided by NVIDIA®. As long as we have the latest Hybrid SLI™ driver, we will update it to our website. Please visit our website for Hybrid SLI™ driver in the future. For the current operation procedures, please refer to "Hybrid SLI™ Operation Guide" on page 21.
7. The maximum shared memory size is defined by the chipset vendor and is subject to change. Please check NVIDIA® website for the latest information.
8. 1080p Blu-ray (BD) / HD-DVD playback support on this motherboard requires the proper hardware configuration. Please refer to page 11 and 12 for the minimum hardware requirement and the passed 1080p Blu-ray (BD) / HD-DVD films in our lab test.

9. This DVI-D port for the chipset adopted on this motherboard can support DVI/HDCP and HDMI format signal. You may use the DVI to HDMI adapter to convert this DVI-D port to HDMI interface. DVI to HDMI adapter is not bundled with our product, please refer to the adapter vendor for further information.
10. Before installing SATAII hard disk to SATAII connector, please read the "SATAII Hard Disk Setup Guide" on page 36 to adjust your SATAII hard disk drive to SATAII mode. You can also connect SATA hard disk to SATAII connector directly.
11. Power Management for USB 2.0 works fine under Microsoft® Windows® Vista™ 64-bit / Vista™ / XP 64-bit / XP SP1 or SP2.
12. WiFi/E header supports WiFi+AP function with ASRock WiFi-802.11g or WiFi-802.11n module, an easy-to-use wireless local area network (WLAN) adapter. It allows you to create a wireless environment and enjoy the convenience of wireless network connectivity. Please visit our website for the availability of ASRock WiFi-802.11g or WiFi-802.11n module. ASRock website <http://www.asrock.com>
13. It is a user-friendly ASRock overclocking tool which allows you to surveil your system by hardware monitor function and overclock your hardware devices to get the best system performance under Windows® environment. Please visit our website for the operation procedures of ASRock OC Tuner. ASRock website: <http://www.asrock.com>
14. Featuring an advanced proprietary hardware and software design, Intelligent Energy Saver is one of the options in ASRock OC Tuner. The voltage regulator can reduce the number of output phases to improve efficiency when the CPU cores are idle. In other words, it is able to provide exceptional power saving and improve power efficiency without sacrificing computing performance. To use Intelligent Energy Saver function, please enable Cool 'n' Quiet option in the BIOS setup in advance. Please visit our website for the operation procedures of Intelligent Energy Saver. ASRock website: <http://www.asrock.com>
15. Although this motherboard offers stepless control, it is not recommended to perform over-clocking. Frequencies other than the recommended CPU bus frequencies may cause the instability of the system or damage the CPU.
16. While CPU overheat is detected, the system will automatically shutdown. Before you resume the system, please check if the CPU fan on the motherboard functions properly and unplug the power cord, then plug it back again. To improve heat dissipation, remember to spray thermal grease between the CPU and the heatsink when you install the PC system.
17. This motherboard supports ASRock AM2 Boost overclocking technology. If you enable this function in the BIOS setup, the memory performance will improve up to 12.5%, but the effect still depends on the AM2 CPU you adopt. Enabling this function will overclock the chipset/CPU reference clock. However, we can not guarantee the system stability for all CPU/DRAM configurations. If your system is unstable after AM2 Boost function is enabled, it may not be applicative to your system. You may choose to disable this function for keeping the stability of your system.

1.3 Minimum Hardware Requirement Table for Windows® Vista™ Premium 2008 and Basic Logo

For system integrators and users who purchase this motherboard and plan to submit Windows® Vista™ Premium 2008 and Basic logo, please follow below table for minimum hardware requirements.

CPU	Sempron 2800+
Memory	512MB x 2 Dual Channel (Premium)
	512MB Single Channel (Basic)
	256MB x 2 Dual Channel (Basic)
VGA	DX10 with WDDM Driver
	DVI with HDCP

* If you use onboard VGA with total system memory size 512MB and plan to submit Windows® Vista™ Basic logo, please adjust the shared memory size of onboard VGA to 64MB. If you use onboard VGA with total system memory size above 512MB and plan to submit Windows® Vista™ Premium or Basic logo, please adjust the shared memory size of onboard VGA to 128MB or above.

* If you plan to use external graphics card on this motherboard, please refer to Premium Discrete requirement at <http://www.asrock.com>

* If the onboard VGA supports DVI, it must also support HDCP function to qualify for Windows® Vista™ Premium 2008 logo.

* After June 1, 2008, all Windows® Vista™ systems are required to meet above minimum hardware requirements in order to qualify for Windows® Vista™ Premium 2008 logo.

1.4 Minimum Hardware Requirement for 1080p Blu-ray (BD) / HD-DVD Playback Support

1080p Blu-ray (BD) / HD-DVD playback support on this motherboard requires the proper hardware configuration. Please refer to below table for the minimum hardware requirement.

CPU	AMD Phenom X3 8400
VGA	Onboard VGA with DVI-D port
Memory	Dual Channel DDR2 533, 1GB x 2
Suggested OS	Windows® Vista™ or Windows® Vista™ 64

* Currently, 1080p Blu-ray (BD) / HD-DVD playback is only supported under Windows® Vista™ / Vista™ 64-bit OS. If you install Windows® XP / XP 64-bit OS, the function of 1080p Blu-ray (BD) / HD-DVD playback is not available, please visit our website for NVIDIA® driver update in the future.

ASRock website <http://www.asrock.com>

1.5 Passed 1080p Blu-ray (BD) / HD-DVD Films in Our Lab Test

DVD Type	Film Name	Format	Producer
Blu-ray DVD	SWORDFISH	VC-1	WB
	UNDERWORLD EVOLUTION	MPEG-2	SONY
	X-MEN III	MPEG-4-AVC	FOX
	SPEED	MPEG-4-AVC	FOX
	CASINO ROYALE	MPEG-4-AVC	SONY
	THE LEAGUE OF EXTRAORDINARY GENTLEMEN	MPEG-4-AVC	FOX
HD- DVD	KING KONG	VC-1	UNIVERSAL
	NEW ORLEANS CONCERT	MPEG-2	WEA
	ONE SIX RIGHT	MPEG-2	TERWILLIGER

* MPEG-4-AVC mentioned above refers to the same format of H.264.

* Above passed films are tested under below configuration.

Items	Configurations
CPU	AMD Phenom X3 8400
VGA	Onboard VGA with DVI-D port
Memory	Dual Channel DDR2 533, 1GB x 2
OS	Windows® Vista™ or Windows® Vista™ 64
Playback Software	CyberLink PowerDVD Ultra
DVD Player	Blu-ray-DVDRW-LG-GBW-H10N (BD)
	HD DVD-HP-TOSD-H802A-01 (HD-DVD)

1.6 Motherboard Layout (K10N78FullHD-hSLI R2.0)

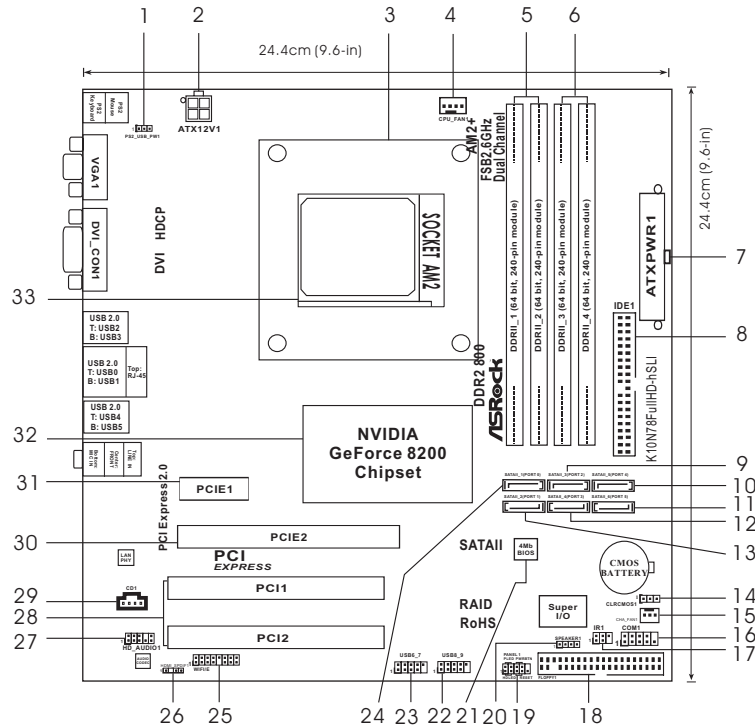

- | | | | |
|----|--|----|---|
| 1 | PS2_USB_PW1 Jumper | 17 | DeskExpress Hot Plug Detection Header (IR1) |
| 2 | ATX 12V Power Connector (ATX12V1) | 18 | Floppy Connector (FLOPPY1) |
| 3 | CPU Heatsink Retention Module | 19 | System Panel Header (PANEL1) |
| 4 | CPU Fan Connector (CPU_FAN1) | 20 | Chassis Speaker Header (SPEAKER 1) |
| 5 | 2 x 240-pin DDR2 DIMM Slots (Dual Channel A: DDRII_1, DDRII_2; Yellow) | 21 | SPI Flash Memory (4Mb) |
| 6 | 2 x 240-pin DDR2 DIMM Slots (Dual Channel B: DDRII_3, DDRII_4; Orange) | 22 | USB 2.0 Header (USB8_9, Blue) |
| 7 | ATX Power Connector (ATXPWR1) | 23 | USB 2.0 Header (USB6_7, Blue) |
| 8 | Primary IDE Connector (IDE1, Blue) | 24 | Primary SATAII Connector (SATAII_1 (PORT0)) |
| 9 | Third SATAII Connector (SATAII_3 (PORT2)) | 25 | WiFi/E Header (WIFI/E) |
| 10 | Fifth SATAII Connector (SATAII_5 (PORT4)) | 26 | HDMI_SPDIF Header (HDMI_SPDIF1) |
| 11 | Sixth SATAII Connector (SATAII_6 (PORT5)) | 27 | Front Panel Audio Header (HD_AUDIO1) |
| 12 | Fourth SATAII Connector (SATAII_4 (PORT3)) | 28 | PCI Slots (PCI1- 2) |
| 13 | Secondary SATAII Connector (SATAII_2 (PORT1)) | 29 | Internal Audio Connector: CD1 (Black) |
| 14 | Clear CMOS Jumper (CLRCMOS1) | 30 | PCI Express 2.0 x16 Slot (PCIE2; Green) |
| 15 | Chassis Fan Connector (CHA_FAN1) | 31 | PCI Express x1 Slot (PCIE1) |
| 16 | Serial Port Connector (COM1) | 32 | NVIDIA GeForce 8200 Chipset |

1.7 Motherboard Layout (K10N78FullHD-hSLI R3.0)

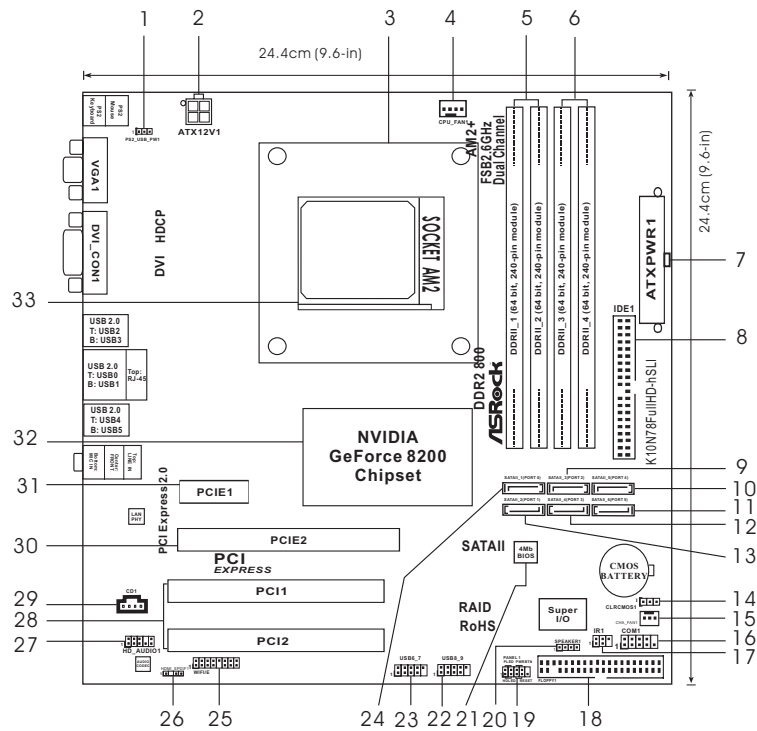

- | | | | |
|----|--|----|---|
| 1 | PS2_USB_PW1 Jumper | 17 | DeskExpress Hot Plug Detection Header (IR1) |
| 2 | ATX 12V Power Connector (ATX12V1) | 18 | Floppy Connector (FLOPPY1) |
| 3 | CPU Heatsink Retention Module | 19 | System Panel Header (PANEL1) |
| 4 | CPU Fan Connector (CPU_FAN1) | 20 | Chassis Speaker Header (SPEAKER 1) |
| 5 | 2 x 240-pin DDR2 DIMM Slots (Dual Channel A: DDRII_1, DDRII_2; Yellow) | 21 | SPI Flash Memory (4Mb) |
| 6 | 2 x 240-pin DDR2 DIMM Slots (Dual Channel B: DDRII_3, DDRII_4; Orange) | 22 | USB 2.0 Header (USB8_9, Blue) |
| 7 | ATX Power Connector (ATXPWR1) | 23 | USB 2.0 Header (USB6_7, Blue) |
| 8 | Primary IDE Connector (IDE1, Blue) | 24 | Primary SATAII Connector (SATAII_1 (PORT0)) |
| 9 | Third SATAII Connector (SATAII_3 (PORT2)) | 25 | WiFi/E Header (WIF/E) |
| 10 | Fifth SATAII Connector (SATAII_5 (PORT4)) | 26 | HDMI_SPDIF Header (HDMI_SPDIF1) |
| 11 | Sixth SATAII Connector (SATAII_6 (PORT5)) | 27 | Front Panel Audio Header (HD_AUDIO1) |
| 12 | Fourth SATAII Connector (SATAII_4 (PORT3)) | 28 | PCI Slots (PCI1-2) |
| 13 | Secondary SATAII Connector (SATAII_2 (PORT1)) | 29 | Internal Audio Connector: CD1 (Black) |
| 14 | Clear CMOS Jumper (CLRCMOS1) | 30 | PCI Express 2.0 x16 Slot (PCIE2; Green) |
| 15 | Chassis Fan Connector (CHA_FAN1) | 31 | PCI Express x1 Slot (PCIE1) |
| 16 | Serial Port Connector (COM1) | 32 | NVIDIA GeForce 8200 Chipset |

1.8 ASRock 6CH_DVI I/O Plus

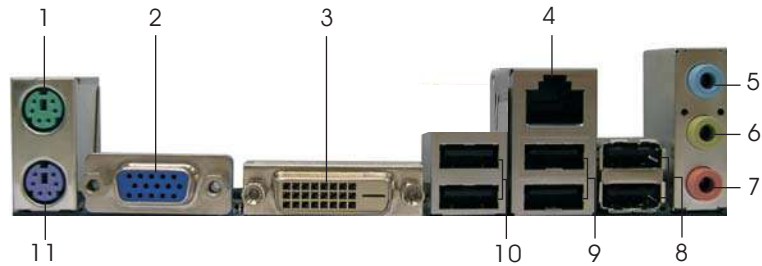

- | | | | |
|-----|-------------------------|-----|-----------------------------|
| 1 | PS/2 Mouse Port (Green) | * 7 | Microphone (Pink) |
| 2 | VGA/D-Sub Port | 8 | USB 2.0 Ports (USB45) |
| * 3 | VGA/DVI-D Port | 9 | USB 2.0 Ports (USB01) |
| 4 | RJ-45 Port | 10 | USB 2.0 Ports (USB23) |
| 5 | Line In (Light Blue) | 11 | PS/2 Keyboard Port (Purple) |
| 6 | Front Speaker (Lime) | | |

* To enable Multi-Streaming function, you need to connect a front panel audio cable to the front panel audio header. Please refer to below steps for the software setting of Multi-Streaming.

For Windows® XP:

After restarting your computer, you will find "Mixer" tool on your system. Please select "Mixer ToolBox" , click "Enable playback multi-streaming", and click "ok". Choose "2CH" or

"4CH" and then you are allowed to select "Realtek HDA Primary output" to use Rear Speaker and Front Speaker, or select "Realtek HDA Audio 2nd output" to use front panel audio. Then reboot your system.

For Windows® Vista™:

After restarting your computer, please double-click "Realtek HD Audio Manager" on the system tray. Set "Speaker Configuration" to "Quadraphonic" or "Stereo". Click "Device advanced settings", choose "Make front and rear output devices playbacks two different audio streams simultaneously", and click "ok". Then reboot your system.

2. Installation

This is a Micro ATX form factor (9.6-in x 9.6-in, 24.4 cm x 24.4 cm) motherboard. Before you install the motherboard, study the configuration of your chassis to ensure that the motherboard fits into it.

Pre-installation Precautions

Take note of the following precautions before you install motherboard components or change any motherboard settings.



Before you install or remove any component, ensure that the power is switched off or the power cord is detached from the power supply. Failure to do so may cause severe damage to the motherboard, peripherals, and/or components.

1. Unplug the power cord from the wall socket before touching any component.
2. To avoid damaging the motherboard components due to static electricity, NEVER place your motherboard directly on the carpet or the like. Also remember to use a grounded wrist strap or touch a safety grounded object before you handle components.
3. Hold components by the edges and do not touch the ICs.
4. Whenever you uninstall any component, place it on a grounded anti-static pad or in the bag that comes with the component.
5. When placing screws into the screw holes to secure the motherboard to the chassis, please do not over-tighten the screws! Doing so may damage the motherboard.

2.1 CPU Installation

- Step 1. Unlock the socket by lifting the lever up to a 90° angle.
- Step 2. Position the CPU directly above the socket such that the CPU corner with the golden triangle matches the socket corner with a small triangle.
- Step 3. Carefully insert the CPU into the socket until it fits in place.



The CPU fits only in one correct orientation. DO NOT force the CPU into the socket to avoid bending of the pins.

- Step 4. When the CPU is in place, press it firmly on the socket while you push down the socket lever to secure the CPU. The lever clicks on the side tab to indicate that it is locked.

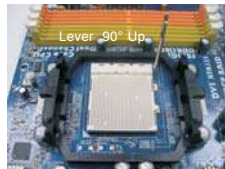

STEP 1:
Lift Up The Socket Lever



STEP 2 / STEP 3:
Match The CPU Golden Triangle To The Socket Corner Small Triangle



STEP 4:
Push Down And Lock The Socket Lever

2.2 Installation of CPU Fan and Heatsink

After you install the CPU into this motherboard, it is necessary to install a larger heatsink and cooling fan to dissipate heat. You also need to spray thermal grease between the CPU and the heatsink to improve heat dissipation. Make sure that the CPU and the heatsink are securely fastened and in good contact with each other. Then connect the CPU fan to the CPU FAN connector (CPU_FAN1, see Page 13/14, No. 4). For proper installation, please kindly refer to the instruction manuals of the CPU fan and the heatsink.

2.3 Installation of Memory Modules (DIMM)

This motherboard provides four 240-pin DDR2 (Double Data Rate 2) DIMM slots, and supports Dual Channel Memory Technology. For dual channel configuration, you always need to install **identical** (the same brand, speed, size and chip-type) DDR2 DIMM pair in the slots of the same color. In other words, you have to install **identical** DDR2 DIMM pair in **Dual Channel A** (DDRII_1 and DDRII_2; Yellow slots; see p.13/14 No.5) or **identical** DDR2 DIMM pair in **Dual Channel B** (DDRII_3 and DDRII_4; Orange slots; see p.13/14 No.6), so that Dual Channel Memory Technology can be activated. This motherboard also allows you to install four DDR2 DIMMs for dual channel configuration, and please install **identical** DDR2 DIMMs in all four slots. You may refer to the Dual Channel Memory Configuration Table below.

Dual Channel Memory Configurations

	DDRII_1 (Yellow Slot)	DDRII_2 (Yellow Slot)	DDRII_3 (Orange Slot)	DDRII_4 (Orange Slot)
(1)	Populated	Populated	-	-
(2)	-	-	Populated	Populated
(3)*	Populated	Populated	Populated	Populated

* For the configuration (3), please install **identical** DDR2 DIMMs in all four slots.



1. If you want to install two memory modules, for optimal compatibility and reliability, it is recommended to install them in the slots of the same color. In other words, install them either in the set of yellow slots (DDRII_1 and DDRII_2), or in the set of orange slots (DDRII_3 and DDRII_4).
2. If only one memory module or three memory modules are installed in the DDR2 DIMM slots on this motherboard, it is unable to activate the Dual Channel Memory Technology.
3. If a pair of memory modules is NOT installed in the same Dual Channel, for example, installing a pair of memory modules in DDRII_1 and DDRII_3, it is unable to activate the Dual Channel Memory Technology .
4. It is not allowed to install a DDR memory module into DDR2 slot; otherwise, this motherboard and DIMM may be damaged.

Installing a DIMM



Please make sure to disconnect power supply before adding or removing DIMMs or the system components.

- Step 1. Unlock a DIMM slot by pressing the retaining clips outward.
Step 2. Align a DIMM on the slot such that the notch on the DIMM matches the break on the slot.

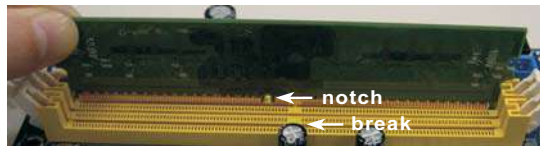
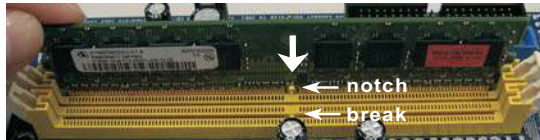

The DIMM only fits in one correct orientation. It will cause permanent damage to the motherboard and the DIMM if you force the DIMM into the slot at incorrect orientation.

- Step 3. Firmly insert the DIMM into the slot until the retaining clips at both ends fully snap back in place and the DIMM is properly seated.

2.4 Expansion Slots (PCI and PCI Express Slots)

There are 2 PCI slots and 2 PCI Express slots on this motherboard.

PCI slots: PCI slots are used to install expansion cards that have the 32-bit PCI interface.

PCI Express slots: PCIE1 (PCI Express x1 slot) is used for PCI Express cards with x1 lane width cards, such as Gigabit LAN card, SATA2 card, etc.

PCIE2 (PCI Express x16 slot) is used for PCI Express cards with x16 lane width graphics cards.

Installing an expansion card

- Step 1. Before installing the expansion card, please make sure that the power supply is switched off or the power cord is unplugged. Please read the documentation of the expansion card and make necessary hardware settings for the card before you start the installation.
- Step 2. Remove the bracket facing the slot that you intend to use. Keep the screws for later use.
- Step 3. Align the card connector with the slot and press firmly until the card is completely seated on the slot.
- Step 4. Fasten the card to the chassis with screws.

2.5 Hybrid SLI™ Operation Guide

This motherboard supports NVIDIA® Hybrid SLI™ feature. Hybrid SLI™ technology, based on NVIDIA®'s industry-leading SLI™ technology, delivers multi-GPU (graphics processing unit) benefits when an NVIDIA® motherboard GPU is combined with an NVIDIA® discrete GPU. Hybrid SLI™ technology today includes two primary features: GeForce® Boost and HybridPower™. Hybrid SLI™ increases graphics performance with GeForce® Boost and provides intelligent power management with HybridPower™. Currently, NVIDIA® Hybrid SLI™ Technology is only supported with Windows® Vista™ OS, and is not available with other OS. Please visit our website for the driver update in the future.

GeForce® Boost

GeForce® Boost turbocharges the performance of NVIDIA® discrete GPU when combined with NVIDIA® motherboard GPU. When GeForce® Boost is enabled, the motherboard GPU and the discrete GPU share the rendering load by rendering different frames of an image. Installing NVIDIA® Hybrid SLI™-enabled graphics card into NVIDIA® Hybrid SLI™-enabled motherboard allows you to enjoy additive performance.

HybridPower™

HybridPower™ enables users to switch off the discrete GPU when the higher processing power of the discrete GPU is not required and use the motherboard GPU for non intensive graphics applications. Switching off the discrete GPU not only lowers the total system power consumption for everyday computing tasks like browsing the Web, word processing, or watching HD videos but also lowers total system noise.

Minimum System Configuration for Hybrid SLI™

For best Hybrid SLI™ benefits, the following minimum system configuration is recommended. Please refer to below table for the minimum system configuration for GeForce® Boost mode and HybridPower™ mode.

GeForce® Boost

CPU	AMD Phenom CPU
Memory	Dual Channel DDR2 800, 1024MB x 2
	256MB or 512MB shared memory for motherboard GPU
Suggested OS	Windows® Vista™ or Windows® Vista™ 64

HybridPower™

CPU	AMD Athlon X2 3800+ CPU
Memory	Dual Channel DDR2 667, 1024MB x 2
	256MB or 512MB shared memory for motherboard GPU
Suggested OS	Windows® Vista™ or Windows® Vista™ 64

Supported PCI Express Card for Hybrid SLI™

GeForce® Boost and HybridPower™ features are supported only with certain set of discrete GPUs. Please refer to our website for the graphics cards update in the future.

For GeForce® Boost

Vendor	Chipset	Model	Driver
NVIDIA	GeForce 8400GS	Gigabyte GV-NX84G256H	174.83
	GeForce 8400GS	Foxconn FV-N84SM2DT	174.83
	GeForce 8400GS	Leadtek WinFast PX8400 GS TDH	174.83
	GeForce 8500GT	Gigabyte GV-NX85T256H	174.83

For HybridPower™

Vendor	Chipset	Model	Driver
NVIDIA	GeForce 9800GX2	ASUS PCIE-ASUS-9800GX2/512M	174.83

Enjoy the benefit of NVIDIA® Hybrid SLI™

To enjoy Hybrid SLI™ feature, please refer to below installation and setup procedures according to the mode you plan to use.



For users using single monitor: If you connect the monitor to the motherboard GPU, you can switch between GeForce® Boost mode (Boost Performance) and HybridPower™ mode (Save Power). If you connect the monitor to the card GPU, you can choose GeForce® Boost mode (Boost Performance) only.

A. GeForce® Boost

- Step 1. Install one compatible PCI Express graphics card to PCIE2 slot (green). For the proper installation procedures, please refer to section “Expansion Slots”.
- Step 2. Connect the monitor cable to the correspondent connector on the PCI Express graphics card on PCIE2 slot.
- Step 3. Boot your system. Press <F2> to enter BIOS setup. Enter “Advanced” screen, and enter “Chipset Settings”. Then set the option “Hybrid SLI” to [256MB] or [512MB].



If you want to use onboard VGA output, after step 1 to 3, please follow below steps:

- A. Set up the BIOS option “Primary Graphics Display” to [Onboard], and save your BIOS change and exit BIOS setup.
- B. Power off your system.
- C. Switch your monitor cable to the connector on the I/O shield.

After reboot your system, you are allowed to switch between GeForce® Boost mode (Boost Performance) and HybridPower™ mode (Save Power) according to your request.

-
- Step 4. Boot into OS. Install Hybrid SLI™ driver from our support CD to your system. Hybrid SLI™ driver is in the following path of ASRock support CD:
(There are two ASRock support CD in the motherboard gift box pack, please choose the one for Windows® Vista™ / Vista™ 64-bit.)

..\Drivers\Hybrid SLI driver\Vista

* Currently, Hybrid SLI™ driver only has Vista™ 32 version, please visit our website for future update.

- Step 5. Restart your computer. Then you will find the Hybrid icon on your Windows® taskbar.
- Step 6. The default setting is GeForce® Boost mode (Boost Performance). You do not need to adjust the setup anymore.

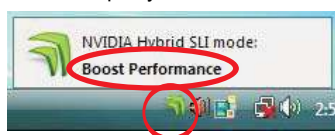

B. HybridPower™

- Step 1. Install one compatible PCI Express graphics card to PCIE2 slot (green). For the proper installation procedures, please refer to section "Expansion Slots".
- Step 2. Boot your system. Press <F2> to enter BIOS setup. Enter "Advanced" screen, and enter "Chipset Settings". Then set the option "Hybrid SLI" to [256MB] or [512MB]. And set the option "Primary Graphics Display" to [Onboard].
- Step 3. Save your BIOS change and exit BIOS setup.
- Step 4. Power off your system.
- Step 5. Connect the monitor cable to the correspondent connector on the I/O shield.
- Step 6. Boot into OS. Install Hybrid SLI™ driver from our support CD to your system. Hybrid SLI™ driver is in the following path of ASRock support CD:
(There are two ASRock support CD in the motherboard gift box pack, please choose the one for Windows® Vista™ / Vista™ 64-bit.)

..\Drivers\Hybrid SLI driver\Vista

* Currently, Hybrid SLI™ driver only has Vista™ 32 version, please visit our website for future update.

- Step 7. Restart your computer. Then you will find the Hybrid icon on your Windows® taskbar. Please click the icon and select the item "Save Power".



- Step 8. Click the desktop. Then your system is switched to HybridPower™ mode (Save Power).

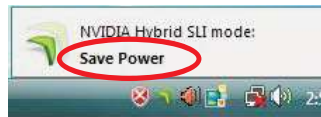

C. Dual Monitors

- Step 1. Install one compatible PCI Express graphics card to PCIE2 slot (green). For the proper installation procedures, please refer to section "Expansion Slots".
- Step 2. Boot your system. Press <F2> to enter BIOS setup. Enter "Advanced" screen, and enter "Chipset Settings". Then set the option "Share Memory" to [32MB], [64MB], [128MB], [256MB] or [512MB].
- Step 3. Connect one monitor cable to the correspondent connector on the I/O shield. Connect the other monitor cable to the correspondent connector on the PCI Express graphics card on PCIE2 slot.
- Step 4. Boot into OS. Install Hybrid SLI™ driver from our support CD to your system. Hybrid SLI™ driver is in the following path of ASRock support CD:
(There are two ASRock support CD in the motherboard gift box pack, please choose the one for Windows® Vista™ / Vista™ 64-bit.)

..\Drivers\Hybrid SLI driver\Vista

* Currently, Hybrid SLI™ driver only has Vista™ 32 version, please visit our website for future update.

- Step 5. Restart your computer. Then you will find the Hybrid icon on your Windows® taskbar. Please click the icon and select the item "Additional Displays".



- Step 6. Click the desktop. Then your system is switched to Dual Monitors mode (Additional Displays).



2.6 Dual Monitor and Surround Display Features

Dual Monitor Feature

This motherboard supports dual monitor feature. With the internal dual VGA output support (DVI-D and D-Sub), you can easily enjoy the benefits of dual monitor feature without installing any add-on VGA card to this motherboard. This motherboard also provides independent display controllers for DVI-D and D-Sub to support dual VGA output so that DVI-D and D-sub can drive same or different display contents. To enable dual monitor feature, please follow the below steps:

1. Connect the DVI-D monitor cable to the VGA/DVI-D port on the I/O panel of this motherboard. Connect the D-Sub monitor cable to the VGA/D-Sub port on the I/O panel of this motherboard.



VGA/D-Sub port VGA/DVI-D port

2. If you have installed onboard VGA driver from our support CD to your system already, you can freely enjoy the benefits of dual monitor function provided by VGA/DVI-D and VGA/D-Sub ports with this motherboard after your system boots. If you haven't installed onboard VGA driver yet, please install onboard VGA driver from our support CD to your system and restart your computer. Then you can start to use dual monitor function provided by VGA/DVI-D and VGA/D-Sub ports with this motherboard.



1. When you playback HDCP-protected video from Blu-ray (BD) or HD-DVD disc, the content will be displayed only in one of the two monitors instead of both monitors.
2. This motherboard does not support dual monitor feature under DOS because in this situation, the VGA/DVI-D output is not available. There is no such limitation under Windows® OS.

Surround Display Feature

This motherboard supports surround display upgrade. With the internal dual VGA output support (DVI-D and D-Sub) and the external add-on PCI Express VGA card, you can easily enjoy the benefits of surround display feature. Please refer to the following steps to set up a surround display environment:

1. Install the NVIDIA® PCI Express VGA card to PCI Express slot. Please refer to page 20 for proper expansion card installation procedures for details.
2. Connect the DVI-D monitor cable to the VGA/DVI-D port on the I/O panel of this motherboard. Connect the D-Sub monitor cable to the VGA/D-Sub port on the I/O panel of this motherboard.
3. Boot your system. Press <F2> to enter BIOS setup. Enter "Share Memory" option to adjust the memory capability to [32MB], [64MB], [128MB], [256MB] or [512MB] to enable the function of VGA/D-sub. Please make sure that the value you select is less than the total capability of the system memory. If you do not adjust the BIOS setup, the default value of "Share Memory", [Auto], will disable VGA/D-Sub function when the add-on VGA card is inserted to this motherboard.
4. Install the onboard VGA driver and the add-on PCI Express VGA card driver to your system. If you have installed the onboard VGA driver and the add-on PCI Express VGA card driver already, there is no need to install them again.
5. Set up a multi-monitor display.

For Windows® XP / XP 64-bit OS:

Right click the desktop, choose "Properties", and select the "Settings" tab so that you can adjust the parameters of the multi-monitor according to the steps below.

- A. Click the "Identify" button to display a large number on each monitor.
- B. Right-click the display icon in the Display Properties dialog that you wish to be your primary monitor, and then select "Primary". When you use multiple monitors with your card, one monitor will always be Primary, and all additional monitors will be designated as Secondary.
- C. Select the display icon identified by the number 2.
- D. Click "Extend my Windows desktop onto this monitor".
- E. Right-click the display icon and select "Attached", if necessary.
- F. Set the "Screen Resolution" and "Color Quality" as appropriate for the second monitor. Click "Apply" or "OK" to apply these new values.
- G. Repeat steps C through E for the display icon identified by the number one, two, three and four.

For Windows® Vista™ / Vista™ 64-bit OS:

Right click the desktop, choose "Personalize", and select the "Display Settings" tab so that you can adjust the parameters of the multi-monitor according to the steps below.

-
- A. Click the number "2" icon.
 - B. Click the items "This is my main monitor" and "Extend the desktop onto this monitor".
 - C. Click "OK" to save your change.
 - D. Repeat steps A through C for the display icon identified by the number three and four.
6. Use Surround Display. Click and drag the display icons to positions representing the physical setup of your monitors that you would like to use. The placement of display icons determines how you move items from one monitor to another.



HDCP Function with DVI-D Port

HDCP function is supported with DVI-D port on this motherboard. To use HDCP function with this motherboard, you need to adopt the monitor that supports HDCP function as well. Therefore, you can enjoy the superior display quality with high-definition HDCP encryption contents. Please refer to below instruction for more details about HDCP function.

What is HDCP?

HDCP stands for High-Bandwidth Digital Content Protection, a specification developed by Intel® for protecting digital entertainment content that uses the DVI interface. HDCP is a copy protection scheme to eliminate the possibility of intercepting digital data midstream between the video source, or transmitter - such as a computer, DVD player or set-top box - and the digital display, or receiver - such as a monitor, television or projector. In other words, HDCP specification is designed to protect the integrity of content as it is being transmitted.

Products compatible with the HDCP scheme such as DVD players, satellite and cable HDTV set-top-boxes, as well as few entertainment PCs requires a secure connection to a compliant display. Due to the increase in manufacturers employing HDCP in their equipment, it is highly recommended that the HDTV or LCD monitor you purchase is compatible.

2.7 HDMI Audio Function Operation Guide

The DVI-D port for the chipset adopted on this motherboard can support DVI/HDCP and HDMI format signal. You may use the DVI to HDMI adapter to convert the DVI-D port to HDMI interface. Please follow below steps to enable HDMI audio function according to the OS you install.



1. DVI to HDMI adapter is not bundled with this motherboard, please refer to the adapter vendor for further information.
2. If you install the DVI-D monitor instead of the HDMI monitor on this motherboard and enable HDMI audio function, the film you play may pause sometimes.

For Windows® XP / XP 64-bit OS

Step 1: Set up BIOS.

- A. Enter BIOS SETUP UTILITY → Advanced screen → Chipset Configuration.
- B. Set the option “OnBoard HDMI HD Audio” to [Auto].

Step 2: Install HDMI audio driver to your system.

Install “Onboard HDMI HD Audio Driver” from ASRock Support CD to your system.

Step 3: Reboot your system.

After you reboot the system, the HDMI audio function is available.



After HDMI audio driver is installed, the OS default will output the audio signal through HDMI audio. Therefore, the onboard audio jack will not function.

For Windows® Vista™ / Vista™ 64-bit OS

Step 1: Set up BIOS.

- A. Enter BIOS SETUP UTILITY → Advanced screen → Chipset Configuration.
- B. Set the option “OnBoard HDMI HD Audio” to [Auto].

Step 2: Enter Windows® to set up your system manually.

- A. Click “Start” button, select “Settings”, and then click “Control Panel”.
- B. Click “Hardware and Sound”, and click “Sound”.
- C. Change the default setting “Speaker” to “Digital Output Device (HDMI)”.
- D. Click “OK” to finish the setting.

Step 3: Reboot your system.

After you reboot the system, the HDMI audio function is available.

2.8 Jumpers Setup

The illustration shows how jumpers are setup. When the jumper cap is placed on pins, the jumper is "Short". If no jumper cap is placed on pins, the jumper is "Open". The illustration shows a 3-pin jumper whose pin1 and pin2 are "Short" when jumper cap is placed on these 2 pins.

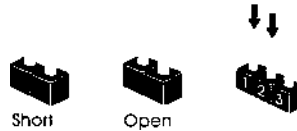

Jumper	Setting	
PS2_USB_PW1 (see p.13/14, No. 1)		Short pin2, pin3 to enable +5VSB (standby) for PS/2 or USB wake up events.

Note: To select +5VSB, it requires 2 Amp and higher standby current provided by power supply.

Clear CMOS Jumper (CLRCMOS1) (see p.13/14, No. 14)		Default		Clear CMOS
--	--	---------	--	------------

Note: CLRCMOS1 allows you to clear the data in CMOS. The data in CMOS includes system setup information such as system password, date, time, and system setup parameters. To clear and reset the system parameters to default setup, please turn off the computer and unplug the power cord from the power supply. After waiting for 15 seconds, use a jumper cap to short pin2 and pin3 on CLRCMOS1 for 5 seconds. However, please do not clear the CMOS right after you update the BIOS. If you need to clear the CMOS when you just finish updating the BIOS, you must boot up the system first, and then shut it down before you do the clear-CMOS action.

2.9 Onboard Headers and Connectors



Onboard headers and connectors are NOT jumpers. Do NOT place jumper caps over these headers and connectors. Placing jumper caps over the headers and connectors will cause permanent damage of the motherboard!

Floppy Connector

(33-pin FLOPPY1)

(see p.13/14 No. 18)



↑
the red-striped side to Pin1

Note: Make sure the red-striped side of the cable is plugged into Pin1 side of the connector.

Primary IDE connector (Blue)

(39-pin IDE1, see p.13/14 No. 8)



connect the blue end
to the motherboard



connect the black end
to the IDE devices

80-conductor ATA 66/100/133 cable

Note: Please refer to the instruction of your IDE device vendor for the details.

Serial ATAII Connectors

(SATAII_1 (PORT0):

see p.13/14, No. 24)

(SATAII_2 (PORT1):

see p.13/14, No. 13)

(SATAII_3 (PORT2):

see p.13/14, No. 9)

(SATAII_4 (PORT3):

see p.13/14, No. 12)

(SATAII_5 (PORT4):

see p.13/14, No. 10)

(SATAII_6 (PORT5):

see p.13/14, No. 11)

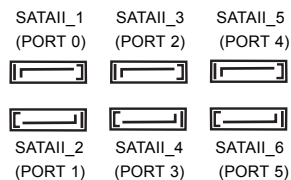

These six Serial ATAII (SATAII)

connectors support SATAII or SATA hard disk for internal storage devices. The current SATAII interface allows up to 3.0 Gb/s data transfer rate.

Serial ATA (SATA)

Data Cable

(Optional)



Either end of the SATA data cable can be connected to the SATA / SATAII hard disk or the SATAII connector on the motherboard.

**Serial ATA (SATA)
Power Cable**
(Optional)

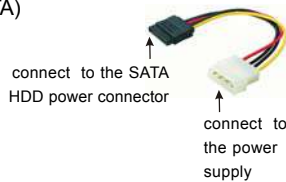

Please connect the black end of SATA power cable to the power connector on each drive. Then connect the white end of SATA power cable to the power connector of the power supply.

USB 2.0 Headers
(9-pin USB8_9)
(see p.13/14 No. 22)

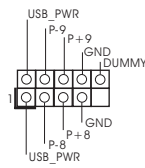

Besides six default USB 2.0 ports on the I/O panel, there are two USB 2.0 headers on this motherboard. Each USB 2.0 header can support two USB 2.0 ports.

(9-pin USB6_7)
(see p.13/14 No. 23)

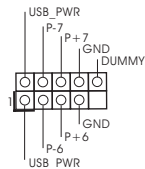

WiFi/E Header
(15-pin WiFi/E)
(see p.13/14 No. 25)

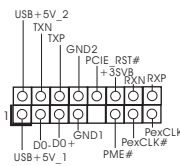

This header supports WiFi+AP function with ASRock WiFi-802.11g or WiFi-802.11n module, an easy-to-use wireless local area network (WLAN) adapter. It allows you to create a wireless environment and enjoy the convenience of wireless network connectivity.



If you don't plan to use WiFi+AP function on this motherboard, this header can be used as a 4-Pin USB 2.0 header to support one USB 2.0 port. To connect the 4-Pin USB device cable to this header, please refer to this picture for proper installation.



DeskExpress Hot Plug Detection Header
(5-pin IR1)
(see p.13/14 No. 17)

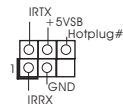

This header supports the Hot Plug detection function for ASRock DeskExpress.

Internal Audio Connectors
(4-pin CD1)
(CD1: see p.13/14 No. 29)

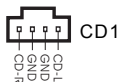

This connector allows you to receive stereo audio input from sound sources such as a CD-ROM, DVD-ROM, TV tuner card, or MPEG card.

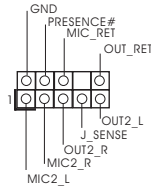

Front Panel Audio Header

(9-pin HD_AUDIO1)
(see p.13/14, No. 27)



This is an interface for the front panel audio cable that allows convenient connection and control of audio devices.



1. High Definition Audio supports Jack Sensing, but the panel wire on the chassis must support HDA to function correctly. Please follow the instruction in our manual and chassis manual to install your system.
2. If you use AC'97 audio panel, please install it to the front panel audio header as below:
 - A. Connect Mic_IN (MIC) to MIC2_L.
 - B. Connect Audio_R (RIN) to OUT2_R and Audio_L (LIN) to OUT2_L.
 - C. Connect Ground (GND) to Ground (GND).
 - D. MIC_RET and OUT_RET are for HD audio panel only. You don't need to connect them for AC'97 audio panel.
 - E. Enter BIOS Setup Utility. Enter Advanced Settings, and then select Chipset Configuration. Set the Front Panel Control option from [Auto] to [Enabled].
 - F. Enter Windows system. Click the icon on the lower right hand taskbar to enter Realtek HD Audio Manager.
For Windows® XP / XP 64-bit OS:
Click "Audio I/O", select "Connector Settings" , choose "Disable front panel jack detection", and save the change by clicking "OK".
For Windows® Vista™ / Vista™ 64-bit OS:
Click the right-top "Folder" icon , choose "Disable front panel jack detection", and save the change by clicking "OK".

System Panel Header

(9-pin PANEL1)
(see p.13/14 No. 19)

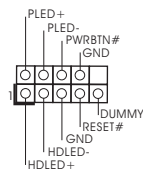

This header accommodates several system front panel functions.

Chassis Speaker Header

(4-pin SPEAKER 1)
(see p.13/14 No. 20)

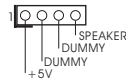

Please connect the chassis speaker to this header.

Chassis Fan Connector

(3-pin CHA_FAN1)
(see p.13/14 No. 15)

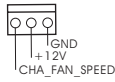

Please connect a chassis fan cable to this connector and match the black wire to the ground pin.

CPU Fan Connector

(4-pin CPU_FAN1)
(see p.13/14 No. 4)

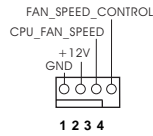

Please connect the CPU fan cable to this connector and match the black wire to the ground pin.



Though this motherboard provides 4-Pin CPU fan (Quiet Fan) support, the 3-Pin CPU fan still can work successfully even without the fan speed control function. If you plan to connect the 3-Pin CPU fan to the CPU fan connector on this motherboard, please connect it to Pin 1-3.

Pin 1-3 Connected ←
3-Pin Fan Installation



ATX Power Connector

(24-pin ATXPWR1)
(see p.13/14 No. 7)

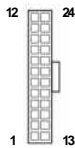

Please connect an ATX power supply to this connector.



Though this motherboard provides 24-pin ATX power connector, it can still work if you adopt a traditional 20-pin ATX power supply. To use the 20-pin ATX power supply, please plug your power supply along with Pin 1 and Pin 13.

20-Pin ATX Power Supply Installation



ATX 12V Power Connector

(4-pin ATX12V1)
(see p.13/14 No. 2)



Please note that it is necessary to connect a power supply with ATX 12V plug to this connector. Failing to do so will cause power up failure.

Serial port Header

(9-pin COM1)
(see p.13/14 No.16)

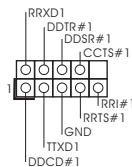

This COM1 header supports a serial port module.

HDMI_SPDIF Header
 (3-pin HDMI_SPDIF1)
 (see p.13/14 No. 26)



HDMI_SPDIF header, providing SPDIF audio output to HDMI VGA card, allows the system to connect HDMI Digital TV/ projector/LCD devices. Please connect the HDMI_SPDIF connector of HDMI VGA card to this header.

HDMI_SPDIF Cable
 (Optional)

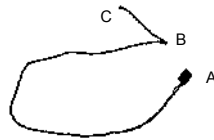

Please connect the black end (A) of HDMI_SPDIF cable to the HDMI_SPDIF header on the motherboard. Then connect the white end (B or C) of HDMI_SPDIF cable to the HDMI_SPDIF connector of HDMI VGA card.

A. black end



B. white end (2-pin)

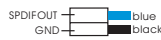

C. white end (3-pin)



2.10 HDMI_SPDIF Header Connection Guide

HDMI (High-Definition Multi-media Interface) is an all-digital audio/video specification, which provides an interface between any compatible digital audio/video source, such as a set-top box, DVD player, A/V receiver and a compatible digital audio or video monitor, such as a digital television (DTV). A complete HDMI system requires a HDMI VGA card and a HDMI ready motherboard with a HDMI_SPDIF header. This motherboard is equipped with a HDMI_SPDIF header, which provides SPDIF audio output to HDMI VGA card, allows the system to connect HDMI Digital TV/projector/ LCD devices. To use HDMI function on this motherboard, please carefully follow the below steps.

Step 1. Install the HDMI VGA card to the PCI Express Graphics slot on this motherboard. For the proper installation of HDMI VGA card, please refer to the installation guide on page 20.

Step 2. Connect the black end (A) of HDMI_SPDIF cable to the HDMI_SPDIF header (HDMI_SPDIF1, yellow, see page 13/14, No. 26) on the motherboard.



Make sure to correctly connect the HDMI_SPDIF cable to the motherboard and the HDMI VGA card according to the same pin definition. For the pin definition of HDMI_SPDIF header and HDMI_SPDIF cable connectors, please refer to page 34. For the pin definition of HDMI_SPDIF connectors on HDMI VGA card, please refer to the user manual of HDMI VGA card vendor. Incorrect connection may cause permanent damage to this motherboard and the HDMI VGA card.

Step 3. Connect the white end (B or C) of HDMI_SPDIF cable to the HDMI_SPDIF connector of HDMI VGA card. (There are two white ends (2-pin and 3-pin) on HDMI_SPDIF cable. Please choose the appropriate white end according to the HDMI_SPDIF connector of the HDMI VGA card you install.



white end
(2-pin) (B)



white end
(3-pin) (C)

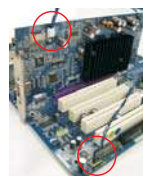

Please do not connect the white end of HDMI_SPDIF cable to the wrong connector of HDMI VGA card or other VGA card. Otherwise, the motherboard and the VGA card may be damaged. For example, this picture shows the wrong example of connecting HDMI_SPDIF cable to the fan connector of PCI Express VGA card. Please refer to the VGA card user manual for connector usage in advance.



Step 4. Connect the HDMI output connector on HDMI VGA card to HDMI device, such as HDTV. Please refer to the user manual of HDTV and HDMI VGA card vendor for detailed connection procedures.



Step 5. Install HDMI VGA card driver to your system.

2.11 SATAII Hard Disk Setup Guide

Before installing SATAII hard disk to your computer, please carefully read below SATAII hard disk setup guide. Some default setting of SATAII hard disks may not be at SATAII mode, which operate with the best performance. In order to enable SATAII function, please follow the below instruction with different vendors to correctly adjust your SATAII hard disk to SATAII mode in advance; otherwise, your SATAII hard disk may fail to run at SATAII mode.

Western Digital



If pin 5 and pin 6 are shorted, SATA 1.5Gb/s will be enabled.

On the other hand, if you want to enable SATAII 3.0Gb/s, please remove the jumpers from pin 5 and pin 6.

SAMSUNG



If pin 3 and pin 4 are shorted, SATA 1.5Gb/s will be enabled.

On the other hand, if you want to enable SATAII 3.0Gb/s, please remove the jumpers from pin 3 and pin 4.

HITACHI

Please use the Feature Tool, a DOS-bootable tool, for changing various ATA features. Please visit HITACHI's website for details:

<http://www.hitachigst.com/hdd/support/download.htm>



The above examples are just for your reference. For different SATAII hard disk products of different vendors, the jumper pin setting methods may not be the same. Please visit the vendors' website for the updates.

2.12 Serial ATA (SATA) / Serial ATAII (SATAII) Hard Disks Installation

This motherboard adopts NVIDIA® GeForce 8200 chipset that supports Serial ATA (SATA) / Serial ATAII (SATAII) hard disks and RAID (RAID 0, RAID 1, RAID 0+1, RAID 5 and JBOD) functions. You may install SATA / SATAII hard disks on this motherboard for internal storage devices. This section will guide you to install the SATA / SATAII hard disks.

STEP 1: Install the SATA / SATAII hard disks into the drive bays of your chassis.

STEP 2: Connect the SATA power cable to the SATA / SATAII hard disk.

STEP 3: Connect one end of the SATA data cable to the motherboard's SATAII connector.

STEP 4: Connect the other end of the SATA data cable to the SATA / SATAII hard disk.



1. If you plan to use RAID 0, RAID 1 or JBOD function, you need to install at least 2 SATA / SATAII hard disks. If you plan to use RAID 5 function, you need to install 3 SATA / SATAII hard disks. If you plan to use RAID 0+1 function, you need to install 4 SATA / SATAII hard disks.
2. Under non-RAID mode, SATAII_5 (PORT4) and SATAII_6 (PORT5) cannot function.

2.13 Hot Plug and Hot Swap Functions for SATA / SATAII HDDs

This motherboard supports Hot Plug and Hot Swap functions for SATA / SATAII Devices in RAID / AHCI mode. NVIDIA® GeForce 8200 chipset provides hardware support for Advanced Host controller Interface (AHCI), a new programming interface for SATA host controllers developed thru a joint industry effort. AHCI also provides usability enhancements such as Hot Plug.



NOTE

What is Hot Plug Function?

If the SATA / SATAII HDDs are NOT set for RAID configuration, it is called "Hot Plug" for the action to insert and remove the SATA / SATAII HDDs while the system is still power-on and in working condition. However, please note that it cannot perform Hot Plug if the OS has been installed into the SATA / SATAII HDD.

What is Hot Swap Function?

If SATA / SATAII HDDs are built as RAID 1 or RAID 5 then it is called "Hot Swap" for the action to insert and remove the SATA / SATAII HDDs while the system is still power-on and in working condition.

2.14 SATA / SATAII HDD Hot Plug Feature and Operation Guide

This motherboard supports Hot Plug feature for SATA / SATAII HDD in RAID / AHCI mode. Please read below operation guide of SATA / SATAII HDD Hot Plug feature carefully. Before you process the SATA / SATAII HDD Hot Plug, please check below cable accessories from the motherboard gift box pack.

A. 7-pin SATA data cable

B. SATA power cable with SATA 15-pin power connector interface

A. SATA data cable (Red)

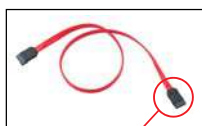

SATA 7-pin
connector

B. SATA power cable



The SATA 15-pin power
connector (Black) connect
to SATA / SATAII HDD

1x4-pin conventional
power connector (White)
connect to power supply

Caution

1. Without SATA 15-pin power connector interface, the SATA / SATAII Hot Plug cannot be processed.
2. Even some SATA / SATAII HDDs provide both SATA 15-pin power connector and IDE 1x4-pin conventional power connector interfaces, the IDE 1x4-pin conventional power connector interface is definitely not able to support Hot Plug and will cause the HDD damage and data loss.

Points of attention, before you process the Hot Plug:

1. Below operation procedure is designed only for our motherboard, which supports SATA / SATAII HDD Hot Plug.
 - * The SATA / SATAII Hot Plug feature might not be supported by the chipset because of its limitation, the SATA / SATAII Hot Plug support information of our motherboard is indicated in the product spec on our website:
www.asrock.com
2. Make sure your SATA / SATAII HDD can support Hot Plug function from your dealer or HDD user manual. The SATA / SATAII HDD, which cannot support Hot Plug function, will be damaged under the Hot Plug operation.
3. Please make sure the SATA / SATAII driver is installed into system properly. The latest SATA / SATAII driver is available on our support website:
www.asrock.com
4. Make sure to use the SATA power cable & data cable, which are from our motherboard package.
5. Please follow below instructions step by step to reduce the risk of HDD crash or data loss.

How to Hot Plug a SATA / SATAII HDD:

Points of attention, before you process the Hot Plug:

Please do follow below instruction sequence to process the Hot Plug, improper procedure will cause the SATA / SATAII HDD damage and data loss.

Step 1 Please connect SATA power cable 1x4-pin end (White) to the power supply 1x4-pin cable.

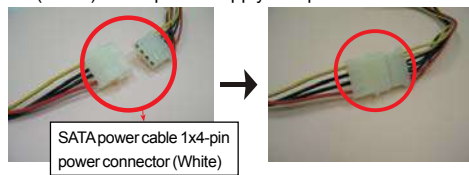

Step 2 Connect SATA data cable to the motherboard's SATAII connector.

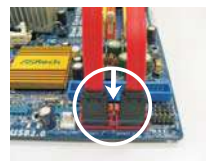

Step 3 Connect SATA 15-pin power cable connector (Black) end to SATA / SATAII HDD.



Step 4 Connect SATA data cable to the SATA / SATAII HDD.



How to Hot Unplug a SATA / SATAII HDD:

Points of attention, before you process the Hot Unplug:

Please do follow below instruction sequence to process the Hot Unplug, improper procedure will cause the SATA / SATAII HDD damage and data loss.

Step 1 Unplug SATA data cable from SATA / SATAII HDD side.

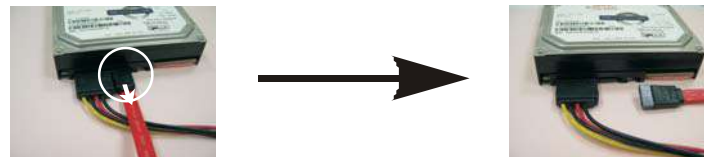

Step 2 Unplug SATA 15-pin power cable connector (Black) from SATA / SATAII HDD side.

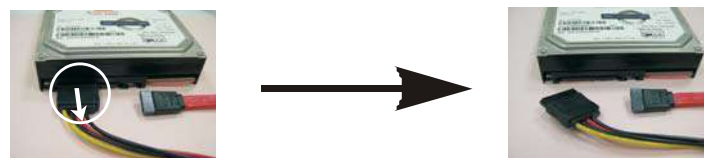

2.15 Driver Installation Guide

To install the drivers to your system, please insert the support CD to your optical drive first. Then, the drivers compatible to your system can be auto-detected and listed on the support CD driver page. Please follow the order from up to bottom side to install those required drivers. Therefore, the drivers you install can work properly.

2.16 Installing Windows® XP / XP 64-bit / Vista™ / Vista™ 64-bit Without RAID Functions

If you want to install Windows® XP, Windows® XP 64-bit, Windows® Vista™ or Windows® Vista™ 64-bit on your SATA / SATAII HDDs without RAID functions, please follow below procedures according to the OS you install.

2.16.1 Installing Windows® XP / XP 64-bit Without RAID Functions

If you want to install Windows® XP / Windows® XP 64-bit on your SATA / SATAII HDDs without RAID functions, please follow below steps.

Using SATA / SATAII HDDs with NCQ and Hot Plug functions

STEP 1: Set Up BIOS.

- A. Enter BIOS SETUP UTILITY → Advanced screen → IDE Configuration.
- B. Set the "SATA Operation Mode" option to [non-RAID].

STEP 2: Make a SATA / SATAII driver diskette.

- A. Insert the ASRock Support CD into your optical drive to boot your system. (There are two ASRock Support CD in the motherboard gift box pack, please choose the one for Windows® XP / XP 64-bit.)
- B. During POST at the beginning of system boot-up, press <F11> key, and then a window for boot devices selection appears. Please select CD-ROM as the boot device.
- C. When you see the message on the screen, "Generate Serial ATA driver diskette [Y/N]?", press <Y>.
- D. Then you will see these messages,

Please choose:

- 1. Generate AHCI Driver diskette for WindowsXP
- 2. Generate RAID Driver diskette for WindowsXP
- 3. Generate AHCI Driver diskette for WindowsXP64
- 4. Generate RAID Driver diskette for WindowsXP64
- 5. Exit

Reboot system now

Press any key to continue

Please insert a floppy diskette into the floppy drive. Select your required item on the list according to the mode you choose and the OS you install. Then press any key.

- E. The system will start to format the floppy diskette and copy SATA / SATAII drivers into the floppy diskette.

STEP 3: Set Up BIOS.

Please follow step 1 to set up the BIOS option "SATA Operation Mode" to [AHCI].

STEP 4: Install Windows® XP / XP 64-bit OS on your system.

You can start to install Windows® XP / XP 64-bit on your system. At the beginning of Windows® setup, press F6 to install a third-party AHCI driver. When prompted, insert the SATA / SATAII driver diskette containing the NVIDIA® AHCI driver. After reading the floppy disk, the driver will be presented. Select the driver to install according to the OS you install. The drivers are as below:

- A. *NVIDIA nForce Storage Controller (required) Windows XP*
- B. *NVIDIA nForce Storage Controller (required) Windows XP64*

Please select A for Windows® XP in AHCI mode. Please select B for Windows® XP 64-bit in AHCI mode.

Using SATA / SATAII HDDs without NCQ and Hot Plug functions

STEP 1: Set Up BIOS.

- A. Enter BIOS SETUP UTILITY → Advanced screen → IDE Configuration.
- B. Set the "SATA Operation Mode" option to [non-RAID].

STEP 2: Install Windows® XP / XP 64-bit OS on your system.

2.16.2 Installing Windows® Vista™ / Vista™ 64-bit Without RAID Functions

If you want to install Windows® Vista™ / Windows® Vista™ 64-bit on your SATA / SATAII HDDs without RAID functions, please follow below steps.

Using SATA / SATAII HDDs with NCQ and Hot Plug functions

STEP 1: Set Up BIOS.

- A. Enter BIOS SETUP UTILITY → Advanced screen → IDE Configuration.
- B. Set the "SATA Operation Mode" option to [AHCI].

STEP 2: Install Windows® Vista™ / Vista™ 64-bit OS on your system.

Insert the Windows® Vista™ / Windows® Vista™ 64-bit optical disk into the optical drive to boot your system, and follow the instruction to install Windows® Vista™ / Windows® Vista™ 64-bit OS on your system. When you see "Where do you want to install Windows?" page, please insert the ASRock Support CD into your optical drive, and click the "Load Driver" button on the left on the bottom to load the NVIDIA® AHCI drivers. NVIDIA® AHCI drivers are in the following path in our Support CD:

(There are two ASRock Support CD in the motherboard gift box pack, please choose the one for Windows® Vista™ / Vista™ 64-bit.)

.. \I386 \AHCI_Vista (For Windows® Vista™ OS)

.. \AMD64\AHCI_Vista64 (For Windows® Vista™ 64-bit OS)

After that, please insert Windows® Vista™ / Windows® Vista™ 64-bit optical disk into the optical drive again to continue the installation.

Using SATA / SATAII HDDs without NCQ and Hot Plug functions

STEP 1: Set Up BIOS.

- A. Enter BIOS SETUP UTILITY → Advanced screen → IDE Configuration.
- B. Set the “SATA Operation Mode” option to [non-RAID].

STEP 2: Install Windows® Vista™ / Vista™ 64-bit OS on your system.

2.17 Installing Windows® XP / XP 64-bit / Vista™ / Vista™ 64-bit With RAID Functions

If you want to install Windows® XP, Windows® XP 64-bit, Windows® Vista™ or Windows® Vista™ 64-bit OS on your SATA / SATAII HDDs with RAID functions, please follow below procedures according to the OS you install.

2.17.1 Installing Windows® XP / XP 64-bit With RAID Functions

If you want to install Windows® XP or Windows® XP 64-bit on your SATA / SATAII HDDs with RAID functions, please follow below steps.

STEP 1: Set Up BIOS.

- A. Enter BIOS SETUP UTILITY → Advanced screen → IDE Configuration.
- B. Set the “SATA Operation Mode” option to [non-RAID].

STEP 2: Make a SATA / SATAII Driver Diskette.

Please make a SATA / SATAII driver diskette by following section 2.16.1 step 2 on page 40.

STEP 3: Set Up BIOS.

Please follow step 1 to set up the BIOS option “SATA Operation Mode” to [RAID].

STEP 4: Use “RAID Installation Guide” to set RAID configuration.

Before you start to configure RAID function, you need to check the RAID installation guide in the Support CD for proper configuration. Please refer to the BIOS RAID installation guide in the following path in the Support CD:

.. \RAID Installation Guide

STEP 5: Install Windows® XP / Windows® XP 64-bit OS on your system.

You can start to install Windows® XP / Windows® XP 64-bit OS on your system. At the beginning of Windows® setup, press F6 to install a third-party RAID driver. When prompted, insert the SATA / SATAII driver diskette containing the NVIDIA® RAID driver. After reading the floppy disk, the drivers will be presented. Select the drivers to install. The drivers are as below:

- A. NVIDIA RAID Driver (required)**
- B. NVIDIA nForce Storage Controller (required)**

Please select A and B for Windows® XP / XP 64-bit in RAID mode. (There are two RAID drivers needed for RAID mode, you have to select them separately. Please specify the first RAID driver and then specify again for the second one.)

NOTE. If you install Windows® XP / Windows® XP 64-bit on IDE HDDs and want to manage (create, convert, delete, or rebuild) RAID functions on SATA / SATAII HDDs, you still need to set up "SATA Operation Mode" to [RAID] in BIOS first. Then, please set the RAID configuration by using the Windows RAID installation guide in the following path in the Support CD:
.. \RAID Installation Guide

2.17.2 Installing Windows® Vista™ / Vista™ 64-bit With RAID Functions

If you want to install Windows® Vista™ or Windows® Vista™ 64-bit on your SATA / SATAII HDDs with RAID functions, please follow below steps.

STEP 1: Set Up BIOS.

- A. Enter BIOS SETUP UTILITY → Advanced screen → IDE Configuration.
- B. Set the "SATA Operation Mode" option to [RAID].

STEP 2: Use "RAID Installation Guide" to set RAID configuration.

Before you start to configure RAID function, you need to check the RAID installation guide in the Support CD for proper configuration. Please refer to the BIOS RAID installation guide part of the document in the following path in the Support CD:

.. \RAID Installation Guide

STEP 3: Install Windows® Vista™ / Windows® Vista™ 64-bit OS on your system.

Insert the Windows® Vista™ / Windows® Vista™ 64-bit optical disk into the optical drive to boot your system, and follow the instruction to install Windows® Vista™ / Windows® Vista™ 64-bit OS on your system. When you see "Where do you want to install Windows?" page, please insert the ASRock Support CD into your optical drive, and click the "Load Driver" button on the left on the bottom to load the NVIDIA® RAID drivers. NVIDIA® RAID drivers are in the following path in our Support CD:

(There are two ASRock Support CD in the motherboard gift box pack, please choose the one for Windows® Vista™ / Vista™ 64-bit.)

.. \I386 \ Vista (For Windows® Vista™ OS)

.. \AMD64 \ Vista64 (For Windows® Vista™ 64-bit OS)

After that, please insert Windows® Vista™ / Windows® Vista™ 64-bit optical disk into the optical drive again to continue the installation.

NOTE. If you install Windows® Vista™ / Windows® Vista™ 64-bit on IDE HDDs and want to manage (create, convert, delete, or rebuild) RAID functions on SATA / SATAII HDDs, you still need to set up "SATA Operation Mode" to [RAID] in BIOS first. Then, please set the RAID configuration by using the Windows RAID installation guide in the following path in the Support CD:

.. \ RAID Installation Guide

2.18 Untied Overclocking Technology

This motherboard supports Untied Overclocking Technology, which means during overclocking, FSB enjoys better margin due to fixed PCI / PCIE buses. Before you enable Untied Overclocking function, please enter "Overclock Mode" option of BIOS setup to set the selection from [Auto] to [CPU, PCIE, Async.]. Therefore, CPU FSB is untied during overclocking, but PCI / PCIE buses are in the fixed mode so that FSB can operate under a more stable overclocking environment.



Please refer to the warning on page 8 for the possible overclocking risk before you apply Untied Overclocking Technology.

3. BIOS SETUP UTILITY

3.1 Introduction

This section explains how to use the BIOS SETUP UTILITY to configure your system. The SPI Memory on the motherboard stores the BIOS SETUP UTILITY. You may run the BIOS SETUP UTILITY when you start up the computer. Please press <F2> during the Power-On-Self-Test (POST) to enter the BIOS SETUP UTILITY, otherwise, POST will continue with its test routines.

If you wish to enter the BIOS SETUP UTILITY after POST, restart the system by pressing <Ctl> + <Alt> + <Delete>, or by pressing the reset button on the system chassis. You may also restart by turning the system off and then back on.



Because the BIOS software is constantly being updated, the following BIOS setup screens and descriptions are for reference purpose only, and they may not exactly match what you see on your screen.

3.1.1 BIOS Menu Bar

The top of the screen has a menu bar with the following selections:

- Main** To set up the system time/date information
- Advanced** To set up the advanced BIOS features
- H/W Monitor** To display current hardware status
- Boot** To set up the default system device to locate and load the Operating System
- Security** To set up the security features
- Exit** To exit the current screen or the BIOS SETUP UTILITY

Use <←> key or <→> key to choose among the selections on the menu bar, and then press <Enter> to get into the sub screen.

3.1.2 Navigation Keys

Please check the following table for the function description of each navigation key.

Navigation Key(s)	Function Description
← / →	Moves cursor left or right to select Screens
↑ / ↓	Moves cursor up or down to select items
+ / -	To change option for the selected items
<Enter>	To bring up the selected screen
<F1>	To display the General Help Screen
<F9>	To load optimal default values for all the settings
<F10>	To save changes and exit the BIOS SETUP UTILITY
<ESC>	To jump to the Exit Screen or exit the current screen

3.2 Main Screen

When you enter the BIOS SETUP UTILITY, the Main screen will appear and display the system overview.

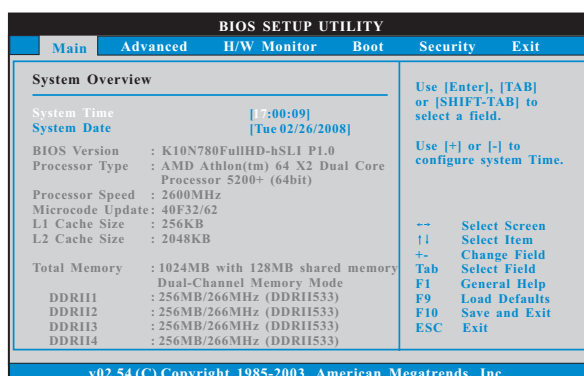

System Time [Hour:Minute:Second]

Use this item to specify the system time.

System Date [Day Month/Date/Year]

Use this item to specify the system date.

3.3 Advanced Screen

In this section, you may set the configurations for the following items: CPU Configuration, Chipset Configuration, ACPI Configuration, IDE Configuration, PCIPnP Configuration, Floppy Configuration, SuperIO Configuration, and USB Configuration.

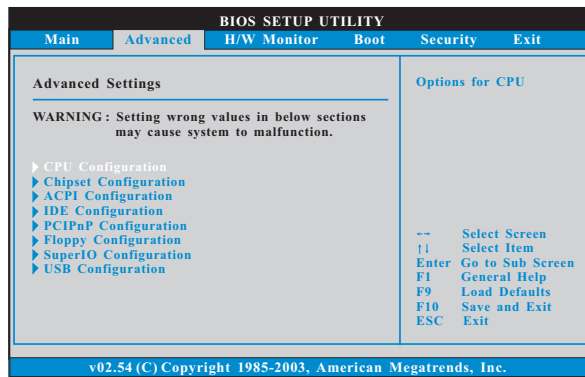

Setting wrong values in this section may cause the system to malfunction.

3.3.1 CPU Configuration

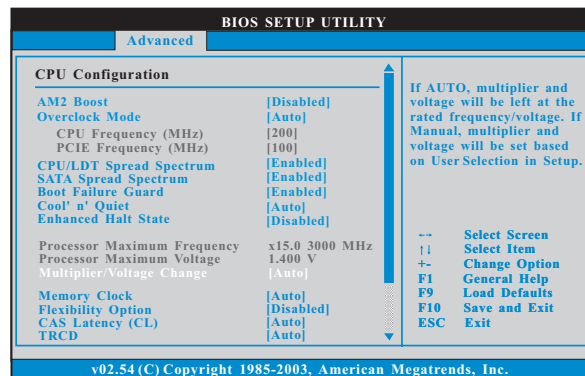

AM2 Boost

This option appears only when you adopt AM2 CPU. If you set this option to [Enabled], you will enable ASRock AM2 Boost function, which will improve the memory performance. The default value is [Disabled]. Please refer to caution 17 on page 9 for details.

Overclock Mode

Use this to select Overclock Mode. The default value is [Auto]. Configuration options: [Auto], [CPU, PCIE, Sync.] and [CPU, PCIE, Async.].

CPU Frequency (MHz)

Use this option to adjust CPU frequency.

PCIE Frequency (MHz)

Use this option to adjust PCIE frequency.

CPU/LDT Spread Spectrum

This feature will be set to [Enabled] as default. Configuration options: [Disabled] and [Enabled].

SATA Spread Spectrum

This feature will be set to [Enabled] as default. Configuration options: [Disabled] and [Enabled].

Boot Failure Guard

Enable or disable the feature of Boot Failure Guard.

Cool 'n' Quiet

Use this item to enable or disable AMD's Cool 'n' Quiet™ technology. The default value is [Auto]. Configuration options: [Auto], [Enabled] and [Disabled]. If you install Windows® Vista™ and want to enable this function, please set this item to [Enabled]. Please note that enabling this function may reduce CPU voltage and memory frequency, and lead to system stability or compatibility issue with some memory modules or power supplies. Please set this item to [Disable] if above issue occurs.

Enhanced Halt State

C1E is an enhanced power saving state which is supported by AM2 dual core and AM2+ multi-core processors. The processor will enter C1E power saving state when both of its cores transition into the C1 state. The default value is [Disabled]. Configuration options: [Enabled] and [Disabled].

Processor Maximum Frequency

It will display Processor Maximum Frequency for reference.

North Bridge Maximum Frequency

This option appears only when you adopt Phenom CPU. It will display North Bridge Maximum Frequency for reference.

Processor Maximum Voltage

It will display Processor Maximum Voltage for reference.

Multiplier/Voltage Change

This item is set to [Auto] by default. If it is set to [Manual], you may adjust the value of Processor Frequency and Processor Voltage. However, it is recommended to keep the default value for system stability.

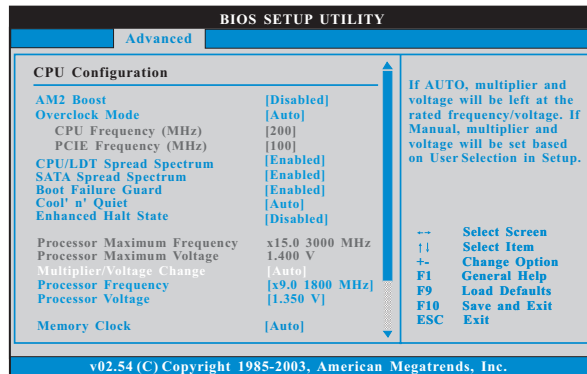

Processor Frequency

This option appears only when you adopt AM2 CPU. This item will show when "Multiplier/Voltage Change" is set to [Manual]; otherwise, it will be hidden. The range of the value depends on the CPU you adopt on this motherboard. However, for system stability, it is not recommended to adjust the value of this item.

Processor Voltage

This option appears only when you adopt AM2 CPU. This item will show when "Multiplier/Voltage Change" is set to [Manual]; otherwise, it will be hidden. The range of the value depends on the CPU you adopt on this motherboard. However, for safety and system stability, it is not recommended to adjust the value of this item.

Processor Target Frequency

This option appears only when you adopt Phenom CPU. This item will show when "Multiplier/Voltage Change" is set to [Manual]; otherwise, it will be hidden. The range of the value depends on the CPU you adopt on this motherboard. However, for system stability, it is not recommended to adjust the value of this item.

North Bridge Target Frequency

This option appears only when you adopt Phenom CPU. This item will show when "Multiplier/Voltage Change" is set to [Manual]; otherwise, it will be hidden. The range of the value depends on the CPU you adopt on this motherboard. However, for safety and system stability, it is not recommended to adjust the value of this item.

CPU Frequency Multiplier

This option appears only when you adopt Phenom CPU. However, for safety and system stability, it is not recommended to adjust the value of this item.

CPU Frequency Divider

This option appears only when you adopt Phenom CPU. However, for safety and system stability, it is not recommended to adjust the value of this item.

CPU Voltage

This option appears only when you adopt Phenom CPU. It allows you to adjust the value of CPU voltage. However, for safety and system stability, it is not recommended to adjust the value of this item.

NB Frequency Multiplier

This option appears only when you adopt Phenom CPU. However, for safety and system stability, it is not recommended to adjust the value of this item.

NB Voltage

This option appears only when you adopt Phenom CPU. It allows you to adjust the value of NB voltage. However, for safety and system stability, it is not recommended to adjust the value of this item.

Memory Clock

This item can be set by the code using [Auto]. You can set one of the standard values as listed: [200 MHz (DDR2 400)], [266 MHz (DDR2 533)], [333 MHz (DDR2 667)] and [400MHz (DDR2 800)]. If you adopt Phenom CPU, there is one more option: [533MHz (DDR2 1066)]

Flexibility Option

The default value of this option is [Disabled]. It will allow better tolerance for memory compatibility when it is set to [Enabled].

CAS Latency (CL)

Use this item to adjust the means of memory accessing. Configuration options: [Auto], [3CLK], [4CLK], [5CLK] and [6CLK]. The default value is [Auto].

TRCD

Use this to adjust TRCD values. Configuration options: [Auto], [3CLK], [4CLK], [5CLK] and [6CLK]. The default value is [Auto].

TRP

Use this to adjust TRP values. Configuration options: [Auto], [3CLK], [4CLK], [5CLK] and [6CLK]. The default value is [Auto].

TRTP

Use this to adjust TRTP values. Configuration options: [Auto], [2-4CLK] and [3-5CLK]. The default value is [Auto].

TRAS

Use this to adjust TRAS values. Configuration options: [Auto], [5CLK] to [18CLK]. The default value is [Auto].

TRRD

Use this to adjust TRRD values. Configuration options: [Auto], [2CLK], [3CLK], [4CLK] and [5CLK]. The default value is [Auto].

TRC

Use this to adjust TRC values. Configuration options: [11CLK] to [25CLK]. The default value is [Auto].

TWR

Use this to adjust TWR values. Configuration options: [Auto], [3CLK], [4CLK], [5CLK] and [6CLK]. The default value is [Auto].

TWTR

Use this to adjust TWTR values. Configuration options: [Auto], [1CLK], [2CLK] and [3CLK]. The default value is [Auto].

TRWTTD

This option appears only when you adopt AM2 CPU. Use this to adjust TRWTTD values. Configuration options: [Auto], [2CLK], [3CLK], [4CLK], [5CLK], [6CLK], [7CLK], [8CLK] and [9CLK]. The default value is [Auto].

TWRRD

This option appears only when you adopt AM2 CPU. Use this to adjust TWRRD values. Configuration options: [Auto], [0CLK], [1CLK], [2CLK] and [3CLK]. The default value is [Auto].

TWRWR

This option appears only when you adopt AM2 CPU. Use this to adjust TWRWR values. Configuration options: [Auto], [1CLK], [2CLK] and [3CLK]. The default value is [Auto].

TRDRD

This option appears only when you adopt AM2 CPU. Use this to adjust TRDRD values. Configuration options: [Auto], [2CLK], [3CLK], [4CLK] and [5CLK]. The default value is [Auto].

MA Timing

Use this to adjust values for MA timing. Configuration options: [Auto], [2T], [1T]. The default value is [Auto].

Addr/Cmd Fine Delay

Use this to adjust values for Addr/Cmd Fine Delay feature. Configuration options: [Auto], [No Delay], [1/64CLK] to [31/64CLK]. The default value is [Auto].

CS/ODT Fine Delay

Use this to adjust values for CS/ODT Fine Delay feature. Configuration options: [Auto], [No Delay], [1/64CLK] to [31/64CLK]. The default value is [Auto].

Bank Interleaving

Interleaving allows memory accesses to be spread out over banks on the same node, or across nodes, decreasing access contention.

3.3.2 Chipset Configuration

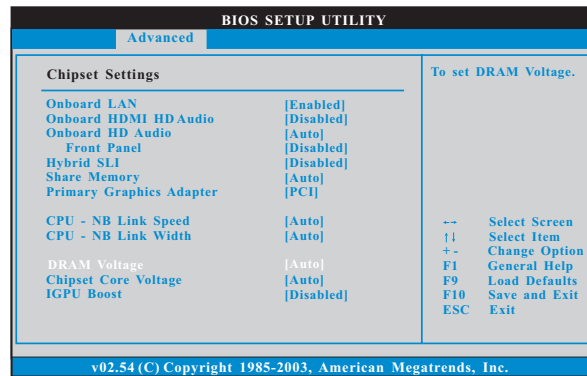

Onboard LAN

This allows you to enable or disable the onboard LAN feature.

Onboard HDMI HD Audio

This allows you to enable or disable the onboard HDMI HD Audio.

Onboard HD Audio

Select [Auto], [Enabled] or [Disabled] for the onboard HD Audio feature. If you select [Auto], the onboard HD Audio will be disabled when PCI Sound Card is plugged.

Front Panel

Select [Auto], [Enabled] or [Disabled] for the onboard HD Audio Front Panel.

Hybrid SLI

Adjust this item if you want this motherboard to support Hybrid SLI™ function. You are allowed to select this option only when the total capacity of the memory module you adopt is 512MB and above. Configuration options: [Disabled], [256MB] and [512MB]. The default value is [Disabled]. If you select [256MB] or [512MB], you are not allowed to adjust the option "Share Memory".

Share Memory

This allows you to set share memory feature. The default value is [Auto]. Configuration options: [Auto], [32MB], [64MB], [128MB], [256MB] and [512MB]. To make sure the proper operation of the system, the option [512MB] only appears when the total capacity of the memory modules you adopt is above 2GB.

Primary Graphics Adapter

This item will switch the PCI Bus scanning order while searching for video card. It allows you to select the type of Primary VGA in case of multiple video controllers. The default value of this feature is [PCI]. Configuration options: [PCI], [Onboard] and [PCI Express]. If you enable Hybrid SLI™, the default value of this option will be [PCI Express], and the option [PCI] will be removed.

CPU - NB Link Speed

This feature allows you selecting CPU to NB link frequency. Configuration options: [Auto], [200 MHz], [400 MHz], [600 MHz], [800 MHz] and [1000 MHz]. The configuratopn options depend on the CPU you adopt. If you adopt Phenom CPU, the configuration options are: [Auto], [200 MHz], [400 MHz], [600 MHz], [800 MHz], [1000 MHz], [1800 MHz], [2000 MHz], [2200 MHz], [2400 MHz] and [2600 MHz].

CPU - NB Link Width

This feature allows you selecting CPU to NB link width. Configuration options: [Auto], [8 Bit] and [16 Bit].

DRAM Voltage

Use this to select DRAM voltage. Configuration options: [Auto], [1.80V], [1.85V], [1.90V], [1.95V], [2.00V], [2.05V], [2.15V] and [2.20V]. The default value is [Auto].

Chipset Core Voltage

Use this to select Chipset Core voltage. Configuration options: [Auto], [1.10V], [1.15V], [1.20V] and [1.25V]. The default value is [Auto].

IGPU Boost

This allows you to enable or disable the iGPU Boost feature. If you select [Enabled], iGPU will be in overlocking mode, which will increase the system performance but may affect the system stability. If you select [Disabled], iGPU will not be in overlocking mode.

3.3.3 ACPI Configuration

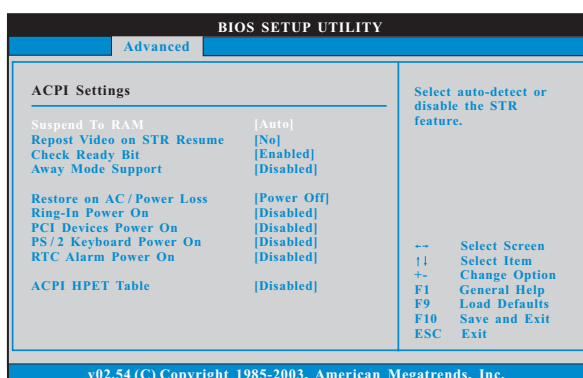

Suspend to RAM

Use this item to select whether to auto-detect or disable the Suspend-to-RAM feature. Select [Auto] will enable this feature if the OS supports it. If you set this item to [Disabled], the function "Repost Video on STR Resume" will be hidden.

Repost Video on STR Resume

This feature allows you to repost video on STR resume. (STR refers to suspend to RAM.)

Check Ready Bit

Use this item to enable or disable the feature Check Ready Bit.

Away Mode Support

Use this item to enable or disable Away Mode support under Windows® XP Media Center OS. The default value is [Disabled].

Restore on AC/Power Loss

This allows you to set the power state after an unexpected AC/power loss. If [Power Off] is selected, the AC/power remains off when the power recovers. If [Power On] is selected, the AC/power resumes and the system starts to boot up when the power recovers.

Ring-In Power On

Use this item to enable or disable Ring-In signals to turn on the system from the power-soft-off mode.

PCI Devices Power On

Use this item to enable or disable PCI devices to turn on the system from the power-soft-off mode.

PS/2 Keyboard Power On

Use this item to enable or disable PS/2 keyboard to turn on the system from the power-soft-off mode.

RTC Alarm Power On

Use this item to enable or disable RTC (Real Time Clock) to power on the system.

ACPI HPET Table

Use this item to enable or disable ACPI HPET Table. The default value is [Disabled]. Please set this option to [Enabled] if you plan to use this motherboard to submit Windows® Vista™ certification.

3.3.4 IDE Configuration

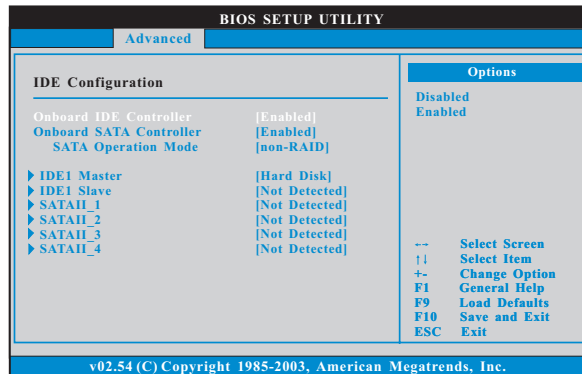

Onboard IDE Controller

Use this item to enable or disable the “Onboard IDE Controller” feature.

Onboard SATA Controller

Use this item to enable or disable the “Onboard SATA Controller” feature.

SATA Operation Mode

Use this item to adjust SATA Operation Mode. The default value of this option is [non-RAID]. If you want to operate RAID function on SATA / SATAII HDDs, please select [RAID]. Configuration options: [non-RAID], [AHC] and [RAID].

* If you select [RAID] mode, SATA / SATAII HDDs can not be accessed until you finish configuring RAID functions in NVIDIA BIOS / Windows RAID Utility.

* If you install OS on SATA / SATAII HDDs, please do not change the setting of this item after OS installation.

* If you install SATA / SATAII device on eSATAII port and plan to make a floppy image or use Ghost under DOS (Disk Operating System), please set this option to [non-RAID].

IDE Device Configuration

You may set the IDE configuration for the device that you specify. We will use the “IDE1 Master” as the example in the following instruction, which can be applied to the configurations of “IDE1 Slave” as well.

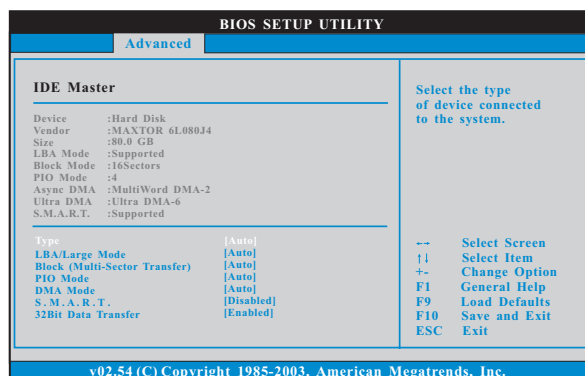

TYPE

Use this item to configure the type of the IDE device that you specify. Configuration options: [Not Installed], [Auto], [CD/DVD], and [ARMD].

[Not Installed]: Select [Not Installed] to disable the use of IDE device.

[Auto]: Select [Auto] to automatically detect the hard disk drive.



After selecting the hard disk information into BIOS, use a disk utility, such as FDISK, to partition and format the new IDE hard disk drives. This is necessary so that you can write or read data from the hard disk. Make sure to set the partition of the Primary IDE hard disk drives to active.

[CD/DVD]: This is used for IDE CD/DVD drives.

[ARMD]: This is used for IDE ARMD (ATAPI Removable Media Device), such as MO.

LBA/Large Mode

Use this item to select the LBA/Large mode for a hard disk > 512 MB under DOS and Windows; for Netware and UNIX user, select [Disabled] to disable the LBA/Large mode.

Block (Multi-Sector Transfer)

The default value of this item is [Auto]. If this feature is enabled, it will enhance hard disk performance by reading or writing more data during each transfer.

PIO Mode

Use this item to set the PIO mode to enhance hard disk performance by optimizing the hard disk timing.

DMA Mode

DMA capability allows the improved transfer-speed and data-integrity for compatible IDE devices.

S.M.A.R.T.

Use this item to enable or disable the S.M.A.R.T. (Self-Monitoring, Analysis, and Reporting Technology) feature. Configuration options: [Disabled], [Auto], [Enabled].

32Bit Data Transfer

Use this item to enable 32-bit access to maximize the IDE hard disk data transfer rate.

3.3.5 PCIPnP Configuration

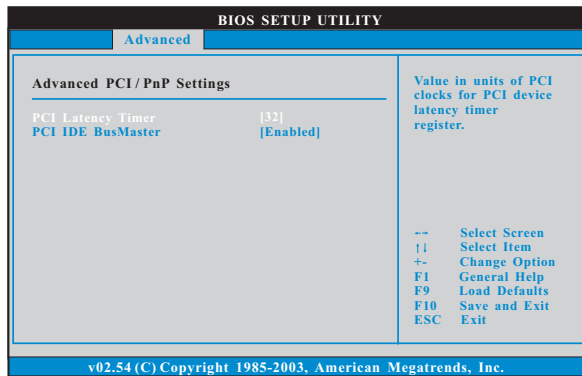

Setting wrong values in this section may cause the system to malfunction.

PCI Latency Timer

The default value is 32. It is recommended to keep the default value unless the installed PCI expansion cards' specifications require other settings.

PCI IDE BusMaster

Use this item to enable or disable the PCI IDE BusMaster feature.

3.3.6 Floppy Configuration

In this section, you may configure the type of your floppy drive.

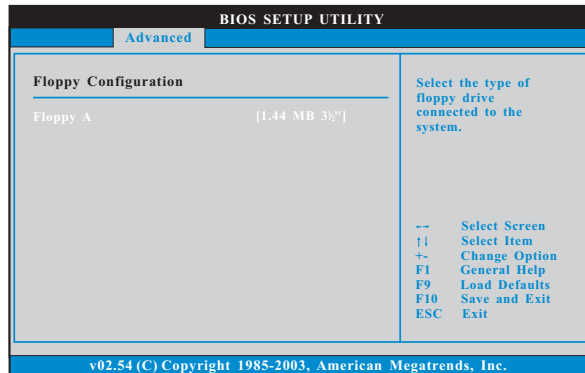

3.3.7 Super IO Configuration

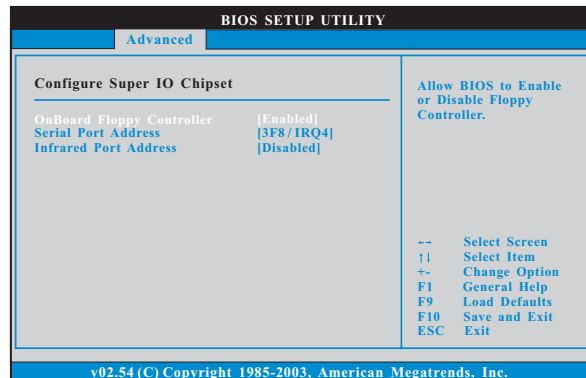

OnBoard Floppy Controller

Use this item to enable or disable floppy drive controller.

Serial Port Address

Use this item to set the address for the onboard serial port or disable it.

Configuration options: [Disabled], [3F8 / IRQ4], [2F8 / IRQ3], [3E8 / IRQ4], [2E8 / IRQ3].

Infrared Port Address

Use this item to set the address for the onboard infrared port or disable it.

Configuration options: [Disabled], [2F8 / IRQ3], and [2E8 / IRQ3]. If you plan to use ASRock DeskExpress on this motherboard, please keep this item on [Disabled] option.

3.3.8 USB Configuration

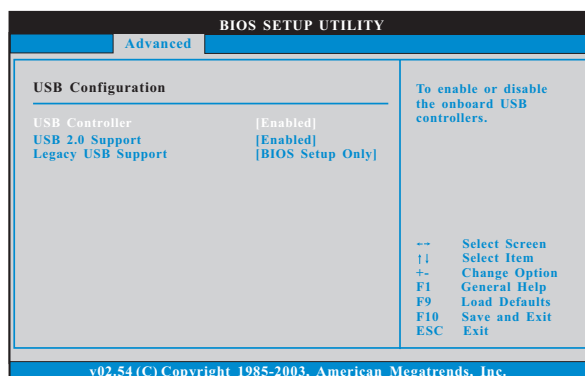

USB Controller

Use this item to enable or disable the use of USB controller.

USB 2.0 Support

Use this item to enable or disable the USB 2.0 support.

Legacy USB Support

Use this option to select legacy support for USB devices. There are four configuration options: [Enabled], [Auto], [Disabled] and [BIOS Setup Only]. The default value is [BIOS Setup Only]. Please refer to below descriptions for the details of these four options:

[Enabled] - Enables support for legacy USB.

[Auto] - Enables legacy support if USB devices are connected.

[Disabled] - USB devices are not allowed to use under legacy OS and BIOS setup when [Disabled] is selected. If you have USB compatibility issue, it is recommended to select [Disabled] to enter OS.

[BIOS Setup Only] - USB devices are allowed to use only under BIOS setup.

3.4 Hardware Health Event Monitoring Screen

In this section, it allows you to monitor the status of the hardware on your system, including the parameters of the CPU temperature, motherboard temperature, CPU fan speed, chassis fan speed, and the critical voltage.

BIOS SETUP UTILITY					
Main	Advanced	H/W Monitor	Boot	Security	Exit
Hardware Health Event Monitoring					
CPU Temperature	:	37°C / 98°F			
M/B Temperature	:	31°C / 87°F			
CPU Fan Speed	:	2833 RPM			
Chassis Fan Speed	:	N/A			
Vcore	:	1.532 V			
+ 3.30V	:	3.129 V			
+ 5.00V	:	4.877 V			
+ 12.00V	:	11.741 V			
CPU Quiet Fan	:	[Disabled]			
			--	Select Screen	
			F1	Select Item	
			F1	General Help	
			F9	Load Defaults	
			F10	Save and Exit	
			ESC	Exit	

v02.54 (C) Copyright 1985-2003, American Megatrends, Inc.

CPU Quiet Fan

This item allows you to control the CPU fan speed and fan noise. If you set this option as [Disabled], the CPU fan will operate in full speed. If you set this option as [Enabled], you will find the items "Target CPU Temperature" and "Target Fan Speed" appear to allow you adjusting them. The default value is [Disabled]. You are allowed to enable this function only when you install 4-pin CPU fan.

Target CPU Temperature

The target temperature will be between 45°C/113°F and 65°C/149°F. The default value is [50°C/122°F].

Target Fan Speed

Use this option to set the target fan speed. You can freely adjust the target fan speed according to the target CPU temperature that you choose. Configuration options: [Level 1], [Level 2], [Level 3], [Level 4], [Level 5], [Level 6] [Level 7], [Level 8] and [Level 9].

3.5 Boot Screen

In this section, it will display the available devices on your system for you to configure the boot settings and the boot priority.

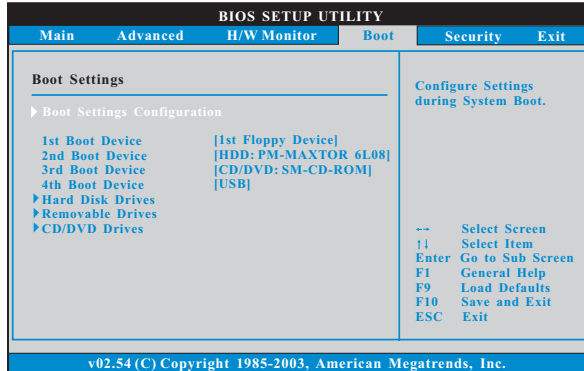

3.5.1 Boot Settings Configuration

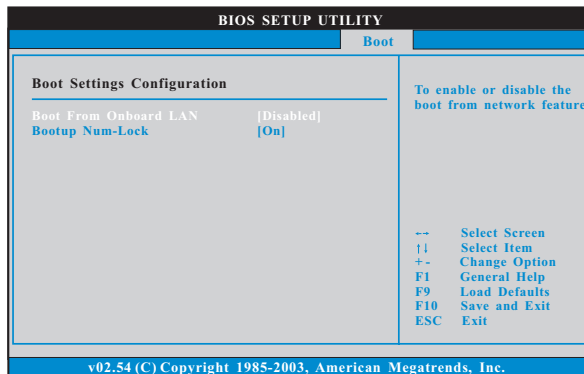

Boot From Onboard LAN

Use this item to enable or disable the Boot From Onboard LAN feature.

Boot Up Num-Lock

If this item is set to [On], it will automatically activate the Numeric Lock function after boot-up.

3.6 Security Screen

In this section, you may set or change the supervisor/user password for the system. For the user password, you may also clear it.

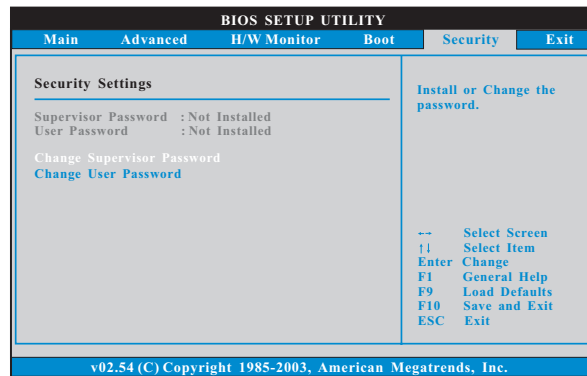

3.7 Exit Screen

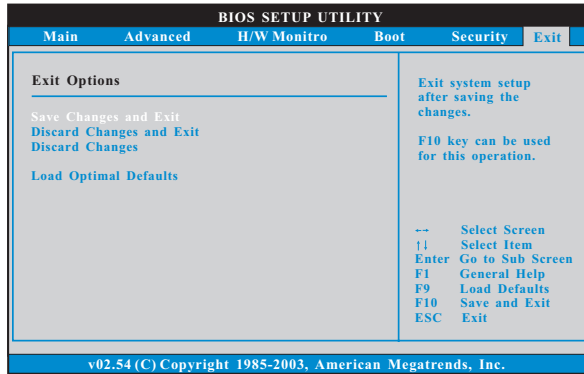

Save Changes and Exit

When you select this option, it will pop-out the following message, “Save configuration changes and exit setup?” Select [OK] to save the changes and exit the BIOS SETUP UTILITY.

Discard Changes and Exit

When you select this option, it will pop-out the following message, “Discard changes and exit setup?” Select [OK] to exit the BIOS SETUP UTILITY without saving any changes.

Discard Changes

When you select this option, it will pop-out the following message, “Discard changes?” Select [OK] to discard all changes.

Load Optimal Defaults

When you select this option, it will pop-out the following message, “Load optimal defaults?” Select [OK] to load the default values for all the setup configurations.

4. Software Support

4.1 Install Operating System

This motherboard supports various Microsoft® Windows® operating systems: XP / XP Media Center / XP 64-bit / Vista™ / Vista™ 64-bit. Because motherboard settings and hardware options vary, use the setup procedures in this chapter for general reference only. Refer to your OS documentation for more information.

4.2 Support CD Information

The Support CD that came with the motherboard contains necessary drivers and useful utilities that enhance the motherboard features.

4.2.1 Running The Support CD

To begin using the support CD, insert the CD into your CD-ROM drive. The CD automatically displays the Main Menu if "AUTORUN" is enabled in your computer. If the Main Menu did not appear automatically, locate and double click on the file "ASSETUP.EXE" from the BIN folder in the Support CD to display the menus.

4.2.2 Drivers Menu

The Drivers Menu shows the available devices drivers if the system detects the installed devices. Please install the necessary drivers to activate the devices.

4.2.3 Utilities Menu

The Utilities Menu shows the applications software that the motherboard supports. Click on a specific item then follow the installation wizard to install it.

4.2.4 Contact Information

If you need to contact ASRock or want to know more about ASRock, welcome to visit ASRock's website at <http://www.asrock.com>; or you may contact your dealer for further information.