

ASRock®



J4105B-ITX

J4005B-ITX

User Manual

Version 1.0

Published October 2017

Copyright©2017 ASRock INC. All rights reserved.

Copyright Notice:

No part of this documentation may be reproduced, transcribed, transmitted, or translated in any language, in any form or by any means, except duplication of documentation by the purchaser for backup purpose, without written consent of ASRock Inc.

Products and corporate names appearing in this documentation may or may not be registered trademarks or copyrights of their respective companies, and are used only for identification or explanation and to the owners' benefit, without intent to infringe.

Disclaimer:

Specifications and information contained in this documentation are furnished for informational use only and subject to change without notice, and should not be constructed as a commitment by ASRock. ASRock assumes no responsibility for any errors or omissions that may appear in this documentation.

With respect to the contents of this documentation, ASRock does not provide warranty of any kind, either expressed or implied, including but not limited to the implied warranties or conditions of merchantability or fitness for a particular purpose.

In no event shall ASRock, its directors, officers, employees, or agents be liable for any indirect, special, incidental, or consequential damages (including damages for loss of profits, loss of business, loss of data, interruption of business and the like), even if ASRock has been advised of the possibility of such damages arising from any defect or error in the documentation or product.



This device complies with Part 15 of the FCC Rules. Operation is subject to the following two conditions:

- (1) this device may not cause harmful interference, and
- (2) this device must accept any interference received, including interference that may cause undesired operation.

CALIFORNIA, USA ONLY

The Lithium battery adopted on this motherboard contains Perchlorate, a toxic substance controlled in Perchlorate Best Management Practices (BMP) regulations passed by the California Legislature. When you discard the Lithium battery in California, USA, please follow the related regulations in advance.

“Perchlorate Material-special handling may apply, see www.dtsc.ca.gov/hazardouswaste/perchlorate”

ASRock Website: <http://www.asrock.com>

AUSTRALIA ONLY

Our goods come with guarantees that cannot be excluded under the Australian Consumer Law. You are entitled to a replacement or refund for a major failure and compensation for any other reasonably foreseeable loss or damage caused by our goods. You are also entitled to have the goods repaired or replaced if the goods fail to be of acceptable quality and the failure does not amount to a major failure. If you require assistance please call ASRock Tel : +886-2-28965588 ext.123 (Standard International call charges apply)

The terms HDMI™ and HDMI High-Definition Multimedia Interface, and the HDMI logo are trademarks or registered trademarks of HDMI Licensing LLC in the United States and other countries.



Contents

Chapter 1 Introduction	1
1.1 Package Contents	1
1.2 Specifications	2
1.3 Motherboard Layout	5
1.4 I/O Panel	7
Chapter 2 Installation	9
2.1 Installing Memory Modules (SO-DIMM)	10
2.2 Expansion Slot (PCI Express Slot)	12
2.3 Jumpers Setup	13
2.4 Onboard Headers and Connectors	14
Chapter 3 Software and Utilities Operation	18
3.1 Installing Drivers	18
3.2 ASRock Live Update & APP Shop	19
3.2.1 UI Overview	19
3.2.2 Apps	20
3.2.3 BIOS & Drivers	23
3.2.4 Setting	24
Chapter 4 UEFI SETUP UTILITY	25
4.1 Introduction	25
4.1.1 UEFI Menu Bar	25
4.1.2 Navigation Keys	26
4.2 Main Screen	27

4.3	Advanced Screen	28
4.3.1	CPU Configuration	29
4.3.2	Chipset Configuration	30
4.3.3	Storage Configuration	32
4.3.4	Super IO Configuration	33
4.3.5	ACPI Configuration	35
4.3.6	USB Configuration	37
4.4	Tools	38
4.5	Hardware Health Event Monitoring Screen	40
4.6	Security Screen	41
4.7	Boot Screen	42
4.8	Exit Screen	44

Chapter 1 Introduction

Thank you for purchasing ASRock J4105B-ITX / J4005B-ITX motherboard, a reliable motherboard produced under ASRock's consistently stringent quality control. It delivers excellent performance with robust design conforming to ASRock's commitment to quality and endurance.

In this manual, Chapter 1 and 2 contains the introduction of the motherboard and step-by-step installation guides. Chapter 3 contains the operation guide of the software and utilities. Chapter 4 contains the configuration guide of the BIOS setup.



Because the motherboard specifications and the BIOS software might be updated, the content of this documentation will be subject to change without notice. In case any modifications of this documentation occur, the updated version will be available on ASRock's website without further notice. If you require technical support related to this motherboard, please visit our website for specific information about the model you are using. You may find the latest VGA cards and CPU support list on ASRock's website as well. ASRock website <http://www.asrock.com>.

1.1 Package Contents

- ASRock J4105B-ITX / J4005B-ITX Motherboard (Mini-ITX Form Factor)
- ASRock J4105B-ITX / J4005B-ITX Quick Installation Guide
- ASRock J4105B-ITX / J4005B-ITX Support CD
- 2 x Serial ATA (SATA) Data Cables (Optional)
- 1 x I/O Panel Shield

1.2 Specifications

- Platform**
- Mini-ITX Form Factor
 - Solid Capacitor design

- CPU**
- Intel® Quad-Core Processor J4105 (up to 2.5 GHz)
(for **J4105B-ITX**)
 - Intel® Dual-Core Processor J4005 (up to 2.7 GHz)
(for **J4005B-ITX**)

- Memory**
- Dual Channel DDR4 Memory Technology
 - 2 x DDR4 SO-DIMM Slots
- * 2GB DRAM per module is not supported.
- Supports DDR4 2400/2133 non-ECC, un-buffered memory
 - Max. capacity of system memory: 8GB

- Expansion Slot**
- 1 x PCI Express 2.0 x16 Slot (PCIe1: x2 mode)

- Graphics**
- Integrated Intel® UHD Graphics 600: 12 EUs inside (Up to 750MHz) (for **J4105B-ITX**)
 - Integrated Intel® UHD Graphics 600: 12 EUs inside (Up to 700MHz) (for **J4005B-ITX**)
 - DX12, OpenGL 4.3, OGL ES 3.0, OpenCL 2.0
 - HW Acceleration Decode: HEVC (H.265) 8 bit, HEVC (H.265)10 bit, H.264 @ Lvl5.2 (AVC), JPEG/MJPEG, VP8, VP9 8bit, VP9 10 bit
 - HW Acceleration Encode: HEVC (H.265) 8 bit, HEVC (H.265)10 bit, H.264 @ Lvl5.2 (AVC), JPEG/MJPEG, VP8, VP9 8bit
 - Dual graphics output: support D-Sub and HDMI ports by independent display controllers
 - Supports HDMI with max. resolution up to 4K x 2K (4096x2160) @ 30Hz
 - Supports D-Sub with max. resolution up to 2048x1536 @ 60Hz
 - Supports Auto Lip Sync, xvYCC and HBR (High Bit Rate Audio) with HDMI Port (Compliant HDMI monitor is required)

- Supports HDCP with HDMI Port
- Supports Full HD 1080p Blu-ray (BD) playback with HDMI Port

Audio

- 7.1 CH HD Audio (Realtek ALC887 Audio Codec)
- * To configure 7.1 CH HD Audio, it is required to use an HD front panel audio module and enable the multi-channel audio feature through the audio driver.
- Supports Surge Protection
 - ELNA Audio Caps

LAN

- PCIE x1 Gigabit LAN 10/100/1000 Mb/s
- Realtek RTL8111H
- Supports Wake-On-LAN
- Supports Lightning/ESD Protection
- Supports Energy Efficient Ethernet 802.3az
- Supports PXE

Rear Panel I/O

- 1 x PS/2 Mouse/Keyboard Port
- 1 x Parallel Port (ECP/EPP Support)
- 1 x Serial Port: COM1
- 1 x D-Sub Port
- 1 x HDMI Port
- 1 x USB 2.0 Port (Supports ESD Protection)
- 3 x USB 3.1 Gen1 Ports (Supports ESD Protection)
- 1 x RJ-45 LAN Port with LED (ACT/LINK LED and SPEED LED)
- HD Audio Jacks: Line in / Front Speaker / Microphone

Storage

- 2 x SATA3 6.0 Gb/s Connectors, support NCQ, AHCI and Hot Plug

Connector

- 1 x COM Port Header
- 1 x Chassis Intrusion and Speaker Header
- 1 x CPU Fan Connector (3-pin)
- 1 x Chassis Fan Connector (3-pin)
- 1 x 24 pin ATX Power Connector
- 1 x Front Panel Audio Connector

- 2 x USB 2.0 Headers (Support 4 USB 2.0 ports) (Supports ESD Protection)
 - 1 x USB 3.1 Gen1 Header (Supports 2 USB 3.1 Gen1 ports) (Supports ESD Protection)
- * USB3_1_2 is shared with USB2_3.

**BIOS
Feature**

- AMI UEFI Legal BIOS with GUI support
- Supports Plug and Play
- ACPI 5.0 compliant wake up events
- Supports jumperfree
- SMBIOS 3.0 support

**Hardware
Monitor**

- CPU/Chassis temperature sensing
- CPU/Chassis Fan Tachometer
- CPU/Chassis Quiet Fan (Auto adjust chassis fan speed by CPU temperature)
- CPU/Chassis Fan multi-speed control
- CASE OPEN detection
- Voltage monitoring: +12V, +5V, +3.3V, CPU Vcore

OS

- Microsoft® Windows® 10 64-bit

**Certifica-
tions**

- FCC, CE
- ErP/EuP ready (ErP/EuP ready power supply is required)

* For detailed product information, please visit our website: <http://www.asrock.com>

1.3 Motherboard Layout

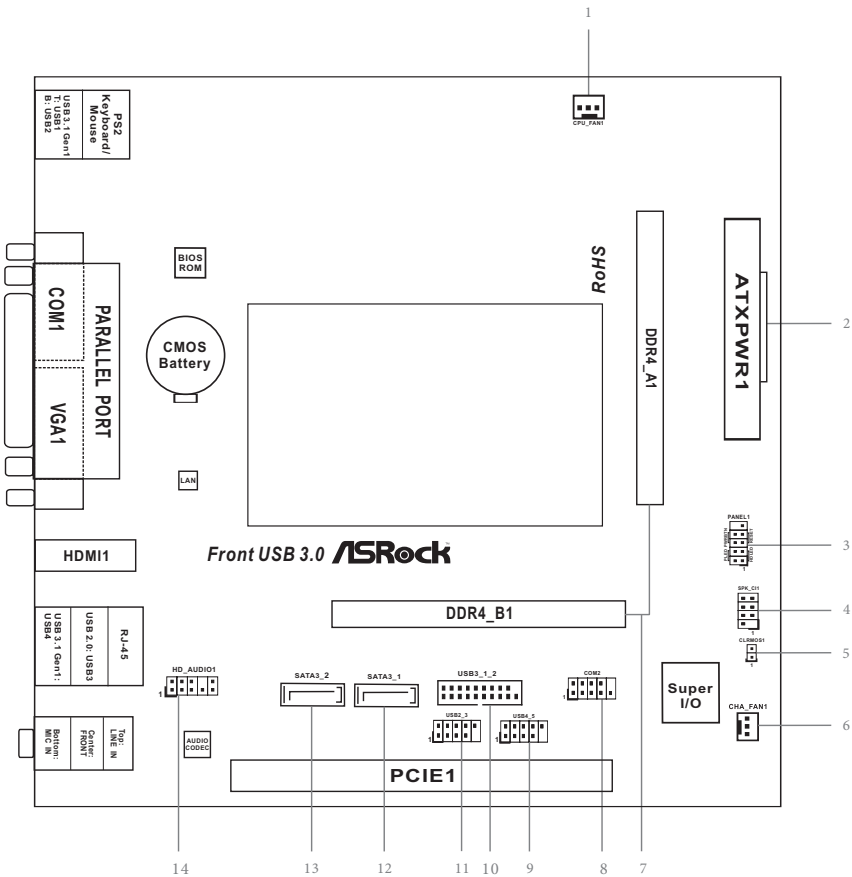

No.	Description
1	CPU Fan Connector (CPU_FAN1)
2	ATX Power Connector (ATXPWR1)
3	System Panel Header (PANEL1)
4	Chassis Intrusion and Speaker Header (SPK_CI1)
5	Clear CMOS Jumper (CLRMOS1)
6	Chassis Fan Connector (CHA_FAN1)
7	2 x 260-pin DDR4 SO-DIMM Slots (DDR4_A1, DDR4_B1)
8	COM Port Header (COM2)
9	USB 2.0 Header (USB4_5)
10	USB 3.1 Gen1 Header (USB3_1_2)
11	USB 2.0 Header (USB2_3)
12	SATA3 Connector (SATA3_1)
13	SATA3 Connector (SATA3_2)
14	Front Panel Audio Header (HD_AUDIO1)

1.4 I/O Panel

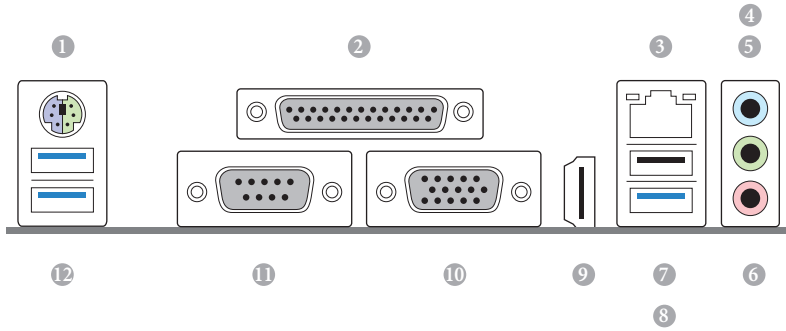

No.	Description	No.	Description
1	PS/2 Mouse/Keyboard Port	7	USB 2.0 Port (USB3_3)
2	Parallel Port	8	USB 3.1 Gen1 Port (USB3_4)
3	LAN RJ-45 Port*	9	HDMI Port
4	Line In (Light Blue)**	10	D-Sub Port
5	Front Speaker (Lime)**	11	COM Port
6	Microphone (Pink)**	12	USB 3.1 Gen1 Ports (USB3_1_2)

* There are two LEDs on the LAN port. Please refer to the table below for the LAN port LED indications.

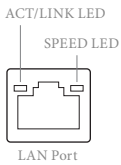

Activity / Link LED		Speed LED	
Status	Description	Status	Description
Off	No Link	Off	10Mbps connection
Blinking	Data Activity	Orange	100Mbps connection
On	Link	Green	1Gbps connection

** To configure 7.1 CH HD Audio, it is required to use an HD front panel audio module and enable the multi-channel audio feature through the audio driver.

Please set Speaker Configuration to “7.1 Speaker” in the Realtek HD Audio Manager.

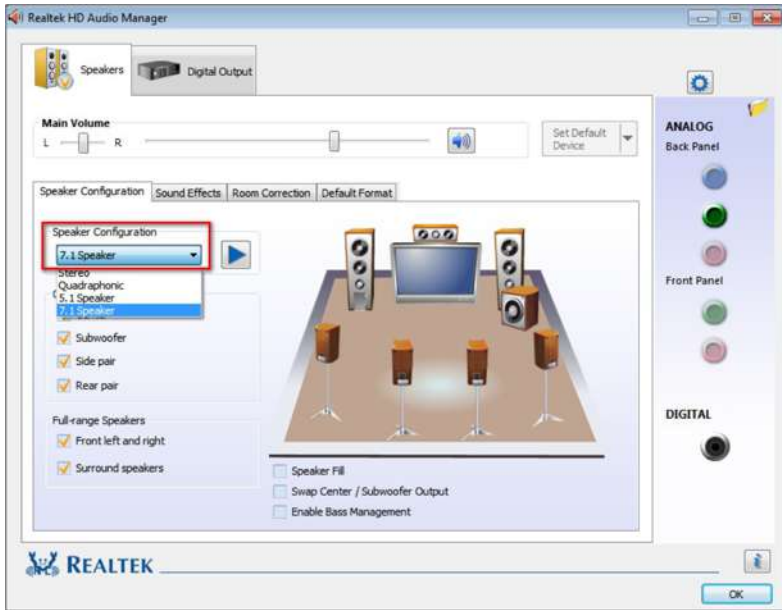

Function of the Audio Ports in 7.1-channel Configuration:

Port	Function
Light Blue (Rear panel)	Rear Speaker Out
Lime (Rear panel)	Front Speaker Out
Pink (Rear panel)	Central /Subwoofer Speaker Out
Lime (Front panel)	Side Speaker Out

Chapter 2 Installation

This is a Mini-ITX form factor motherboard. Before you install the motherboard, study the configuration of your chassis to ensure that the motherboard fits into it.

Pre-installation Precautions

Take note of the following precautions before you install motherboard components or change any motherboard settings.

- Make sure to unplug the power cord before installing or removing the motherboard. Failure to do so may cause physical injuries to you and damages to motherboard components.
- In order to avoid damage from static electricity to the motherboard's components, NEVER place your motherboard directly on a carpet. Also remember to use a grounded wrist strap or touch a safety grounded object before you handle the components.
- Hold components by the edges and do not touch the ICs.
- Whenever you uninstall any components, place them on a grounded anti-static pad or in the bag that comes with the components.
- When placing screws to secure the motherboard to the chassis, please do not over-tighten the screws! Doing so may damage the motherboard.

2.1 Installing Memory Modules (SO-DIMM)

This motherboard provides two 260-pin DDR4 (Double Data Rate 4) SO-DIMM slots, and supports Dual Channel Memory Technology.



1. It is not allowed to install a DDR, DDR2 or DDR3 memory module into a DDR4 slot; otherwise, this motherboard and SO-DIMM may be damaged.
2. The SO-DIMM only fits in one correct orientation. It will cause permanent damage to the motherboard and the SO-DIMM if you force the SO-DIMM into the slot at incorrect orientation.

Supported DDR4 Non ECC SODIMM

Raw Card

A (1Rx8)

B (2Rx8)

C (1Rx16)

Dual Channel Memory Configuration

DDR4_A1

Populated

DDR4_B1

Populated

1

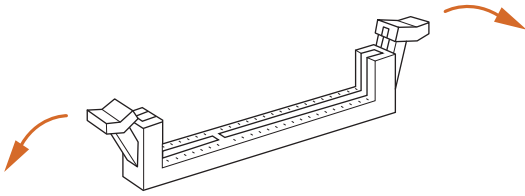

2

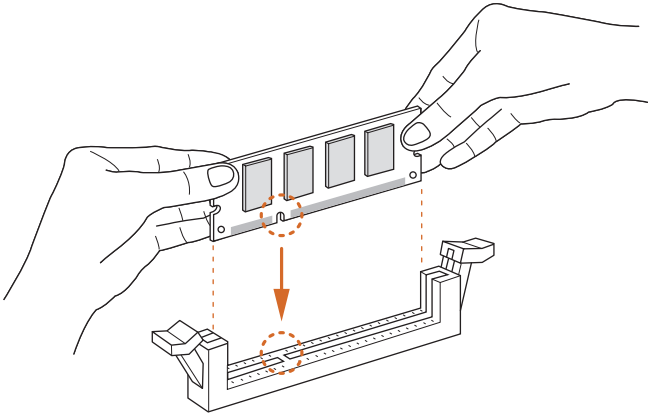

3

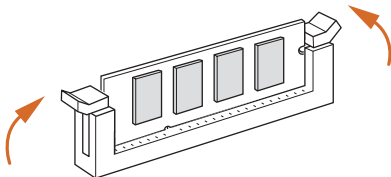

2.2 Expansion Slot (PCI Express Slot)

There is 1 PCI Express slot on the motherboard.



Before installing an expansion card, please make sure that the power supply is switched off or the power cord is unplugged. Please read the documentation of the expansion card and make necessary hardware settings for the card before you start the installation.

PCIe slot:

PCIe1 (PCIe 2.0 x16 slot) is used for PCI Express x2 lane width cards.

Warning:

To ensure better graphics compability, the BIOS is set to "boot from Onboard VGA" as default even the user install a VGA card on PCIe slot.

2.3 Jumpers Setup

The illustration shows how jumpers are setup. When the jumper cap is placed on the pins, the jumper is “Short”. If no jumper cap is placed on the pins, the jumper is “Open”.



Short



Open

*The jumper cap is not provided.

Clear CMOS Jumper
(CLRMO51)
(see p.5, No. 5)



2-pin Jumper

Short: Clear CMOS
Open: Default

CLRMO51 allows you to clear the data in CMOS. The data in CMOS includes system setup information such as system password, date, time, and system setup parameters. There are two ways for you to clear and reset the system parameters to the default setup. Please turn off the computer and unplug the power cord, then you may either short the solder points on CLRMO51 by using metal material, e.g., a paper clip for 3 seconds; or you may use a jumper cap to short the pin on CLRMO51 for 3 seconds. Please remember to remove the paper clip or the jumper cap after clearing the CMOS.



If you clear the CMOS, the case open may be detected. Please adjust the BIOS option “Clear Status” to clear the record of previous chassis intrusion status.

2.4 Onboard Headers and Connectors



Onboard headers and connectors are NOT jumpers. Do NOT place jumper caps over these headers and connectors. Placing jumper caps over the headers and connectors will cause permanent damage to the motherboard.

System Panel Header
(9-pin PANEL1)
(see p.5, No. 3)

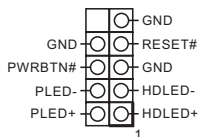

Connect the power switch, reset switch and system status indicator on the chassis to this header according to the pin assignments below. Note the positive and negative pins before connecting the cables.



PWRBTN (Power Switch):

Connect to the power switch on the chassis front panel. You may configure the way to turn off your system using the power switch.

RESET (Reset Switch):

Connect to the reset switch on the chassis front panel. Press the reset switch to restart the computer if the computer freezes and fails to perform a normal restart.

PLED (System Power LED):

Connect to the power status indicator on the chassis front panel. The LED is on when the system is operating. The LED keeps blinking when the system is in S1/S3 sleep state. The LED is off when the system is in S4 sleep state or powered off (S5).

HDLED (Hard Drive Activity LED):

Connect to the hard drive activity LED on the chassis front panel. The LED is on when the hard drive is reading or writing data.

The front panel design may differ by chassis. A front panel module mainly consists of power switch, reset switch, power LED, hard drive activity LED, speaker and etc. When connecting your chassis front panel module to this header, make sure the wire assignments and the pin assignments are matched correctly.

Chassis Intrusion and
Speaker Header
(7-pin SPK_C11)
(see p.5, No. 4)

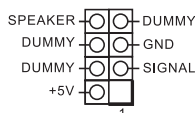

Please connect the chassis intrusion and the chassis speaker to this header.

Serial ATA3 Connectors
(SATA3_1:
see p.5, No. 12)
(SATA3_2:
see p.5, No. 13)

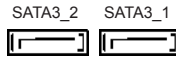

These two SATA3 connectors support SATA data cables for internal storage devices with up to 6.0 Gb/s data transfer rate.

USB 2.0 Headers
(9-pin USB2_3)
(see p.5, No. 11)
(9-pin USB4_5)
(see p.5, No. 9)

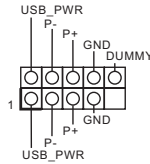

There are two headers on this motherboard. Each USB 2.0 header can support two ports.

USB 3.1 Gen1 Header
(19-pin USB3_1_2)
(see p.5, No. 10)

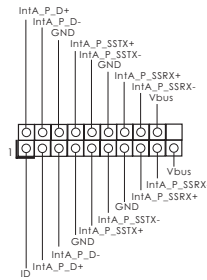

There is one header on this motherboard. This USB 3.1 Gen1 header can support two ports.

Front Panel Audio Header
(9-pin HD_AUDIO1)
(see p.5, No. 14)

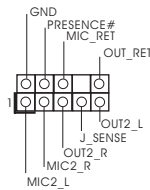

This header is for connecting audio devices to the front audio panel.



1. High Definition Audio supports Jack Sensing, but the panel wire on the chassis must support HDA to function correctly. Please follow the instructions in our manual and chassis manual to install your system.
2. If you use an AC'97 audio panel, please install it to the front panel audio header by the steps below:
 - A. Connect Mic_IN (MIC) to MIC2_L.
 - B. Connect Audio_R (RIN) to OUT2_R and Audio_L (LIN) to OUT2_L.
 - C. Connect Ground (GND) to Ground (GND).
 - D. MIC_RET and OUT_RET are for the HD audio panel only. You don't need to connect them for the AC'97 audio panel.
 - E. To activate the front mic, go to the "FrontMic" Tab in the Realtek Control panel and adjust "Recording Volume".

Chassis Fan Connector
(3-pin CHA_FAN1)
(see p.5, No. 6)

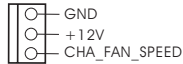

Please connect fan cable to the fan connector and match the black wire to the ground pin.

CPU Fan Connector
(3-pin CPU_FAN1)
(see p.5, No. 1)

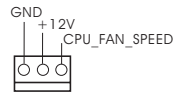

Please connect the CPU fan cable to the connector and match the black wire to the ground pin.

ATX Power Connector
(24-pin ATXPWR1)
(see p.5, No. 2)

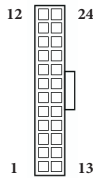

This motherboard provides a 24-pin ATX power connector. To use a 20-pin ATX power supply, please plug it along Pin 1 and Pin 13.

Serial Port Header
(9-pin COM2)
(see p.5, No. 8)

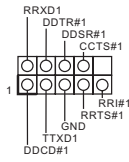

This COM2 header
supports a serial port
module.

Chapter 3 Software and Utilities Operation

3.1 Installing Drivers

The Support CD that comes with the motherboard contains necessary drivers and useful utilities that enhance the motherboard's features.

Running The Support CD

To begin using the support CD, insert the CD into your CD-ROM drive. The CD automatically displays the Main Menu if "AUTORUN" is enabled in your computer. If the Main Menu does not appear automatically, locate and double click on the file "ASRSETUP.EXE" in the Support CD to display the menu.

Drivers Menu

The drivers compatible to your system will be auto-detected and listed on the support CD driver page. Please click **Install All** or follow the order from top to bottom to install those required drivers. Therefore, the drivers you install can work properly.

Utilities Menu

The Utilities Menu shows the application software that the motherboard supports. Click on a specific item then follow the installation wizard to install it.

3.2 ASRock Live Update & APP Shop

The ASRock Live Update & APP Shop is an online store for purchasing and downloading software applications for your ASRock computer. You can quickly and easily install various apps and support utilities. With ASRock Live Update & APP Shop, you can optimize your system and keep your motherboard up to date simply with a few clicks.

Double-click  on your desktop to access ASRock Live Update & APP Shop utility.

**You need to be connected to the Internet to download apps from the ASRock Live Update & APP Shop.*

3.2.1 UI Overview

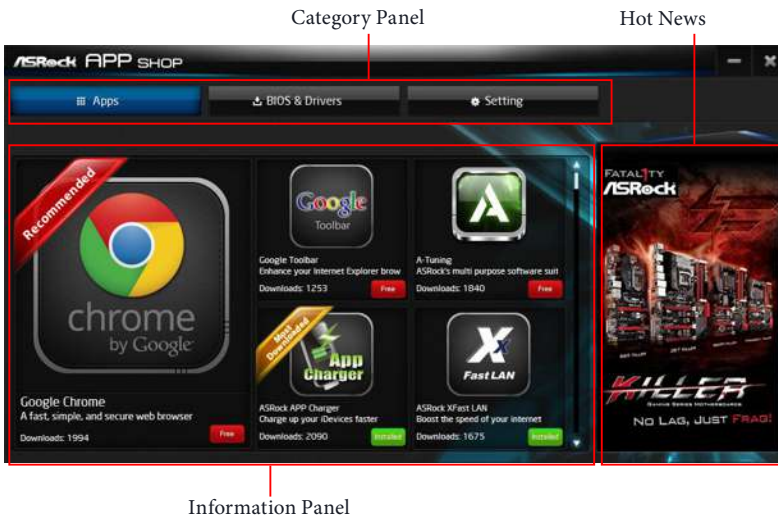

Category Panel: The category panel contains several category tabs or buttons that when selected the information panel below displays the relative information.

Information Panel: The information panel in the center displays data about the currently selected category and allows users to perform job-related tasks.

Hot News: The hot news section displays the various latest news. Click on the image to visit the website of the selected news and know more.

3.2.2 Apps

When the "Apps" tab is selected, you will see all the available apps on screen for you to download.

Installing an App

Step 1

Find the app you want to install.



The most recommended app appears on the left side of the screen. The other various apps are shown on the right. Please scroll up and down to see more apps listed.

You can check the price of the app and whether you have already installed it or not.

Free - The red icon displays the price or "Free" if the app is free of charge.

Installed - The green "Installed" icon means the app is installed on your computer.

Step 2

Click on the app icon to see more details about the selected app.

Step 3

If you want to install the app, click on the red icon  to start downloading.



Step 4

When installation completes, you can find the green "Installed" icon appears on the upper right corner.



To uninstall it, simply click on the trash can icon .
*The trash icon may not appear for certain apps.

Upgrading an App

You can only upgrade the apps you have already installed. When there is an available new version for your app, you will find the mark of "New Version"  appears below the installed app icon.



Step 1

Click on the app icon to see more details.

Step 2

Click on the yellow icon  to start upgrading.

3.2.3 BIOS & Drivers

Installing BIOS or Drivers

When the "BIOS & Drivers" tab is selected, you will see a list of recommended or critical updates for the BIOS or drivers. Please update them all soon.

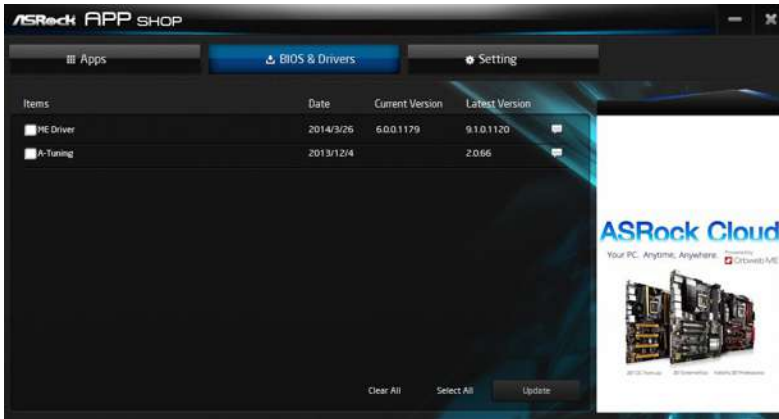

Step 1

Please check the item information before update. Click on  to see more details.

Step 2

Click to select one or more items you want to update.

Step 3

Click Update to start the update process.

3.2.4 Setting

In the "Setting" page, you can change the language, select the server location, and determine if you want to automatically run the ASRock Live Update & APP Shop on Windows startup.



Chapter 4 UEFI SETUP UTILITY

4.1 Introduction

This section explains how to use the UEFI SETUP UTILITY to configure your system. You may run the UEFI SETUP UTILITY by pressing <F2> or right after you power on the computer, otherwise, the Power-On-Self-Test (POST) will continue with its test routines. If you wish to enter the UEFI SETUP UTILITY after POST, restart the system by pressing <Ctl> + <Alt> + <Delete>, or by pressing the reset button on the system chassis. You may also restart by turning the system off and then back on.



Because the UEFI software is constantly being updated, the following UEFI setup screens and descriptions are for reference purpose only, and they may not exactly match what you see on your screen.

4.1.1 UEFI Menu Bar

The top of the screen has a menu bar with the following selections:

Main	For setting system time/date information
Advanced	For advanced system configurations
Tool	Useful tools
H/W Monitor	Displays current hardware status
Security	For security settings
Boot	For configuring boot settings and boot priority
Exit	Exit the current screen or the UEFI Setup Utility

4.1.2 Navigation Keys

Use <←> key or <→> key to choose among the selections on the menu bar, and use <↑> key or <↓> key to move the cursor up or down to select items, then press <Enter> to get into the sub screen. You can also use the mouse to click your required item.

Please check the following table for the descriptions of each navigation key.

Navigation Key(s)	Description
+ / -	To change option for the selected items
<Tab>	Switch to next function
<PGUP>	Go to the previous page
<PGDN>	Go to the next page
<HOME>	Go to the top of the screen
<END>	Go to the bottom of the screen
<F1>	To display the General Help Screen
<F7>	Discard changes and exit the SETUP UTILITY
<F9>	Load optimal default values for all the settings
<F10>	Save changes and exit the SETUP UTILITY
<F12>	Print screen
<ESC>	Jump to the Exit Screen or exit the current screen

4.2 Main Screen

When you enter the UEFI SETUP UTILITY, the Main screen will appear and display the system overview.

J4105B-ITX:



J4005B-ITX:



4.3 Advanced Screen

In this section, you may set the configurations for the following items:
CPU Configuration, Chipset Configuration, Storage Configuration, Super IO Configuration, ACPI Configuration and USB Configuration.



Setting wrong values in this section may cause the system to malfunction.

4.3.1 CPU Configuration



Intel SpeedStep Technology

Intel SpeedStep technology allows processors to switch between multiple frequencies and voltage points for better power saving and heat dissipation.

CPU C States Support

Enable CPU C States Support for power saving. It is recommended to keep C1 and C6 all enabled for better power saving.

Enhanced Halt State (C1E)

Enable Enhanced Halt State (C1E) for lower power consumption.

Intel Turbo Boost Technology

Intel Turbo Boost Technology enables the processor to run above its base operating frequency when the operating system requests the highest performance state.

VT-d

Intel® Virtualization Technology for Directed I/O helps your virtual machine monitor better utilize hardware by improving application compatibility and reliability, and providing additional levels of manageability, security, isolation, and I/O performance.

4.3.2 Chipset Configuration



DRAM Voltage

Use this to configure DRAM Voltage. The default value is [Auto].

Primary Graphics Adapter

Select a primary VGA.

Share Memory

Configure the size of memory that is allocated to the integrated graphics processor when the system boots up.

Onboard HD Audio

Enable/disable onboard HD audio. Set to Auto to enable onboard HD audio and automatically disable it when a sound card is installed.

Front Panel

Enable/disable front panel HD audio.

Onboard LAN

Enable or disable the onboard network interface controller.

PCIE1 Link Speed

Select the link speed for PCIE1.

ASPM

This option enables/disables the ASPM support.

Deep Sleep

Configure deep sleep mode for power saving when the computer is shut down.

Restore on AC/Power Loss

Select the power state after a power failure. If [Power Off] is selected, the power will remain off when the power recovers. If [Power On] is selected, the system will start to boot up when the power recovers.

4.3.3 Storage Configuration



SATA Controller(s)

Enable/disable the SATA controllers.

SATA Mode Selection

AHCI: Supports new features that improve performance.



AHCI (Advanced Host Controller Interface) supports NCQ and other new features that will improve SATA disk performance.

SATA Aggressive Link Power Management

SATA Aggressive Link Power Management allows SATA devices to enter a low power state during periods of inactivity to save power. It is only supported by AHCI mode.

Hard Disk S.M.A.R.T.

S.M.A.R.T stands for Self-Monitoring, Analysis, and Reporting Technology. It is a monitoring system for computer hard disk drives to detect and report on various indicators of reliability.

4.3.4 Super IO Configuration



Serial Port 1

Enable or disable the Serial port 1.

Serial Port Address

Select the address of the Serial port.

Serial Port 2

Enable or disable the Serial port 2.

Serial Port Address

Select the address of the Serial port.

Parallel Port

Enable or disable the Parallel port.

Change Settings

Select the address of the Parallel port.

Device Mode

Select the device mode according to your connected device.

PS2 Y-Cable

Enable the PS2 Y-Cable or set this option to Auto.

4.3.5 ACPI Configuration



Suspend to RAM

It is recommended to select auto for ACPI S3 power saving.

ACPI HPET Table

Enable the High Precision Event Timer for better performance and to pass WHQL tests.

PS/2 Keyboard Power On

Allow the system to be waked up by a PS/2 Keyboard.

PCIE Device Power On

Allow the system to be waked up by a PCIE device and enable wake on LAN.

Ring-In Power On

Allow the system to be waked up by onboard COM port modem Ring-In signals.

RTC Alarm Power On

Allow the system to be waked up by the real time clock alarm. Set it to By OS to let it be handled by your operating system.

USB Keyboard/Remote Power On

Allow the system to be waked up by an USB keyboard or remote controller.

USB Mouse Power On

Allow the system to be waked up by an USB mouse.

4.3.6 USB Configuration



Legacy USB Support

Enable Legacy USB Support. AUTO option disables legacy support if no USB devices are connected. DISABLE option will keep USB devices available only for EFI applications.

4.4 Tools



Instant Flash

Save UEFI files in your USB storage device and run Instant Flash to update your UEFI.

Internet Flash

ASRock Internet Flash downloads and updates the latest UEFI firmware version from our servers for you. Please setup network configuration before using Internet Flash.

*For BIOS backup and recovery purpose, it is recommended to plug in your USB pen drive before using this function.

Network Configuration

Use this to configure internet connection settings for Internet Flash.



Internet Setting

Enable or disable sound effects in the setup utility.

UEFI Download Server

Select a server to download the UEFI firmware.

4.5 Hardware Health Event Monitoring Screen

This section allows you to monitor the status of the hardware on your system, including the parameters of the CPU temperature, motherboard temperature, fan speed and voltage.



CPU Fan 1 Setting

This allows you to set CPU fan 1's speed. Configuration options: [Full On] and [Automatic Mode]. The default value is [Full On].

Chassis Fan 1 Setting

This allows you to set chassis fan 1's speed. Configuration options: [Full On], [Automatic Mode] and [Manual]. The default value is [Full On].

Case Open Feature

Enable or disable Case Open Feature to detect whether the chassis cover has been removed.

4.6 Security Screen

In this section you may set or change the supervisor/user password for the system. You may also clear the user password.



Supervisor Password

Set or change the password for the administrator account. Only the administrator has authority to change the settings in the UEFI Setup Utility. Leave it blank and press enter to remove the password.

User Password

Set or change the password for the user account. Users are unable to change the settings in the UEFI Setup Utility. Leave it blank and press enter to remove the password.

Secure Boot

Enable to support Secure Boot.

Intel(R) Platform Trust Technology

Enable/disable Intel PTT in ME. Disable this option to use discrete TPM Module.

4.7 Boot Screen

This section displays the available devices on your system for you to configure the boot settings and the boot priority.



Fast Boot

Fast Boot minimizes your computer's boot time. In fast mode you may not boot from an USB storage device. The VBIOS must support UEFI GOP if you are using an external graphics card. Please notice that Ultra Fast mode will boot so fast that the only way to enter this UEFI Setup Utility is to Clear CMOS or run the Restart to UEFI utility in Windows.

Boot From Onboard LAN

Allow the system to be waked up by the onboard LAN.

Setup Prompt Timeout

Configure the number of seconds to wait for the setup hot key.

Bootup Num-Lock

Select whether Num Lock should be turned on or off when the system boots up.

Boot Beep

Select whether the Boot Beep should be turned on or off when the system boots up. Please note that a buzzer is needed.

Full Screen Logo

Enable to display the boot logo or disable to show normal POST messages.

Boot Failure Guard Message

If the computer fails to boot for a number of times the system automatically restores the default settings.

4.8 Exit Screen



Save Changes and Exit

When you select this option the following message, “Save configuration changes and exit setup?” will pop out. Select [OK] to save changes and exit the UEFI SETUP UTILITY.

Discard Changes and Exit

When you select this option the following message, “Discard changes and exit setup?” will pop out. Select [OK] to exit the UEFI SETUP UTILITY without saving any changes.

Discard Changes

When you select this option the following message, “Discard changes?” will pop out. Select [OK] to discard all changes.

Load UEFI Defaults

Load UEFI default values for all options. The F9 key can be used for this operation.

Launch EFI Shell from filesystem device

Copy shellx64.efi to the root directory to launch EFI Shell.

Contact Information

If you need to contact ASRock or want to know more about ASRock, you're welcome to visit ASRock's website at <http://www.asrock.com>; or you may contact your dealer for further information. For technical questions, please submit a support request form at <https://event.asrock.com/tsd.asp>

ASRock Incorporation

2F., No.37, Sec. 2, Jhongyang S. Rd., Beitou District,
Taipei City 112, Taiwan (R.O.C.)

ASRock EUROPE B.V.

Bijsterhuizen 11-11

6546 AR Nijmegen

The Netherlands

Phone: +31-24-345-44-33

Fax: +31-24-345-44-38

ASRock America, Inc.

13848 Magnolia Ave, Chino, CA91710

U.S.A.

Phone: +1-909-590-8308

Fax: +1-909-590-1026

DECLARATION OF CONFORMITY

Per FCC Part 2 Section 2.1077(a)



Responsible Party Name: ASRock Incorporation

Address: 13848 Magnolia Ave, Chino, CA91710

Phone/Fax No: +1-909-590-8308/+1-909-590-1026

hereby declares that the product

Product Name : Motherboard

Model Number : J4105B-ITX / J4005B-ITX

Conforms to the following specifications:

FCC Part 15, Subpart B, Unintentional Radiators

Supplementary Information:

This device complies with part 15 of the FCC Rules. Operation is subject to the following two conditions: (1) This device may not cause harmful interference, and (2) this device must accept any interference received, including interference that may cause undesired operation.

Representative Person's Name: James

Signature:

A handwritten signature in black ink, appearing to read 'James', written over a horizontal line.

Date: May 12, 2017

EU Declaration of Conformity



For the following equipment:

Motherboard

(Product Name)

J4105B-ITX / J4005B-ITX / ASRock

(Model Designation / Trade Name)

ASRock Incorporation

(Manufacturer Name)

2F., No.37, Sec. 2, Jhongyang S. Rd., Beitou District, Taipei City 112, Taiwan (R.O.C.)

(Manufacturer Address)

EMC — Directive 2014/30/EU (from April 20th, 2016)

EN 55022:2010/AC:2011 Class B

EN 55024:2010/A1:2015

EN 55032:2012+AC:2013 Class B

EN 61000-3-3:2013

EN 61000-3-2:2014

LVD — Directive 2014/35/EU (from April 20th, 2016)

EN 60950-1 : 2011+ A2: 2013

EN 60950-1 : 2006/A12: 2011

RoHS — Directive 2011/65/EU

CE marking

(EU conformity marking)



ASRock EUROPE B.V.

(Company Name)

Bijsterhuizen 1111 6546 AR Nijmegen The Netherlands

(Company Address)

Person responsible for making this declaration:

(Name, Surname)

A.V.P

(Position / Title)

December 29, 2017

(Date)

P/N: 15G062066000AK V1.0