

ASRock

**H110 PRO
BTC+**

User Manual

Version 1.0

Published June 2017

Copyright©2017 ASRock INC. All rights reserved.

Copyright Notice:

No part of this documentation may be reproduced, transcribed, transmitted, or translated in any language, in any form or by any means, except duplication of documentation by the purchaser for backup purpose, without written consent of ASRock Inc.

Products and corporate names appearing in this documentation may or may not be registered trademarks or copyrights of their respective companies, and are used only for identification or explanation and to the owners' benefit, without intent to infringe.

Disclaimer:

Specifications and information contained in this documentation are furnished for informational use only and subject to change without notice, and should not be constructed as a commitment by ASRock. ASRock assumes no responsibility for any errors or omissions that may appear in this documentation.

With respect to the contents of this documentation, ASRock does not provide warranty of any kind, either expressed or implied, including but not limited to the implied warranties or conditions of merchantability or fitness for a particular purpose.

In no event shall ASRock, its directors, officers, employees, or agents be liable for any indirect, special, incidental, or consequential damages (including damages for loss of profits, loss of business, loss of data, interruption of business and the like), even if ASRock has been advised of the possibility of such damages arising from any defect or error in the documentation or product.



This device complies with Part 15 of the FCC Rules. Operation is subject to the following two conditions:

- (1) this device may not cause harmful interference, and
- (2) this device must accept any interference received, including interference that may cause undesired operation.

CALIFORNIA, USA ONLY

The Lithium battery adopted on this motherboard contains Perchlorate, a toxic substance controlled in Perchlorate Best Management Practices (BMP) regulations passed by the California Legislature. When you discard the Lithium battery in California, USA, please follow the related regulations in advance.

“Perchlorate Material-special handling may apply, see www.dtsc.ca.gov/hazardouswaste/perchlorate”

ASRock Website: <http://www.asrock.com>

AUSTRALIA ONLY

Our goods come with guarantees that cannot be excluded under the Australian Consumer Law. You are entitled to a replacement or refund for a major failure and compensation for any other reasonably foreseeable loss or damage caused by our goods. You are also entitled to have the goods repaired or replaced if the goods fail to be of acceptable quality and the failure does not amount to a major failure. If you require assistance please call ASRock Tel : +886-2-28965588 ext.123 (Standard International call charges apply)

Contents

Chapter 1 Introduction	1
1.1 Package Contents	1
1.2 Specifications	2
1.3 Motherboard Layout	6
1.4 I/O Panel	8
Chapter 2 Installation	10
2.1 Installing the CPU	11
2.2 Installing the CPU Fan and Heatsink	14
2.3 Installing Memory Modules (DIMM)	15
2.4 Expansion Slots (PCI Express Slots)	17
2.5 Jumpers Setup	18
2.6 Onboard Headers and Connectors	19
2.7 PCIe Power Connector Installation Guide	23
2.8 M.2_SSD (NGFF) Module Installation Guide	24
Chapter 3 Software and Utilities Operation	27
3.1 Installing Drivers	27
3.2 ASRock Live Update & APP Shop	28
3.2.1 UI Overview	28
3.2.2 Apps	29
3.2.3 BIOS & Drivers	32
3.2.4 Setting	33
3.3 Enabling USB Ports for Windows® 7 Installation	34

Chapter 4 UEFI SETUP UTILITY	37
4.1 Introduction	37
4.1.1 UEFI Menu Bar	37
4.1.2 Navigation Keys	38
4.2 Main Screen	39
4.3 OC Tweaker Screen	40
4.4 Advanced Screen	48
4.4.1 CPU Configuration	49
4.4.2 Chipset Configuration	51
4.4.3 Storage Configuration	54
4.4.4 Super IO Configuration	55
4.4.5 ACPI Configuration	56
4.4.6 USB Configuration	58
4.4.7 Trusted Computing	59
4.5 Tools	60
4.6 Hardware Health Event Monitoring Screen	61
4.7 Security Screen	63
4.8 Boot Screen	64
4.9 Exit Screen	67

Chapter 1 Introduction

Thank you for purchasing ASRock H110 Pro BTC+ motherboard, a reliable motherboard produced under ASRock's consistently stringent quality control. It delivers excellent performance with robust design conforming to ASRock's commitment to quality and endurance.

In this documentation, Chapter 1 and 2 contains the introduction of the motherboard and step-by-step installation guides. Chapter 3 contains the operation guide of the software and utilities. Chapter 4 contains the configuration guide of the BIOS setup.



Because the motherboard specifications and the BIOS software might be updated, the content of this documentation will be subject to change without notice. In case any modifications of this documentation occur, the updated version will be available on ASRock's website without further notice. If you require technical support related to this motherboard, please visit our website for specific information about the model you are using. You may find the latest VGA cards and CPU support list on ASRock's website as well. ASRock website <http://www.asrock.com>.

1.1 Package Contents

- ASRock H110 Pro BTC+ Motherboard (ATX Form Factor)
- ASRock H110 Pro BTC+ Quick Installation Guide
- ASRock H110 Pro BTC+ Support CD
- 1 x I/O Panel Shield
- 2 x Serial ATA (SATA) Data Cables (Optional)
- 1 x Screw for M.2 Socket (Optional)

1.2 Specifications

- Platform**
- ATX Form Factor
 - Solid Capacitor design

- CPU**
- Supports 7th and 6th Generation Intel® Core™ i7/i5/i3/Pentium®/Celeron® Processors (Socket 1151)
 - Supports CPU up to 91W
 - Digi Power design
 - 8 Power Phase design
 - Supports Intel® Turbo Boost 2.0 Technology

- Chipset**
- Intel® H110

- Memory**
- Dual Channel DDR4 Memory Technology
 - 2 x DDR4 DIMM Slots
 - Supports DDR4 2400/2133 non-ECC, un-buffered memory*
* 7th Gen Intel® CPU supports DDR4 up to 2400; 6th Gen Intel® CPU supports DDR4 up to 2133.
 - Supports ECC UDIMM memory modules (operate in non-ECC mode)
 - Max. capacity of system memory: 32GB
 - Supports Intel® Extreme Memory Profile (XMP) 2.0
 - 15μ Gold Contact in DIMM Slots

- Expansion Slot**
- 1 x PCI Express 3.0 x16 Slot (PCIE2: x16 mode)*
- * Supports NVMe SSD as boot disk
- 12 x PCI Express 2.0 x1 Slots

- Graphics**
- Intel® HD Graphics Built-in Visuals and the VGA outputs can be supported only with processors which are GPU integrated.
 - Supports Intel® HD Graphics Built-in Visuals : Intel® Quick Sync Video with AVC, MVC (S3D) and MPEG-2 Full HW Encode1, Intel® InTru™ 3D, Intel® Clear Video HD Technology, Intel® Insider™, Intel® HD Graphics
 - Gen9 LP, DX11.3, DX12
 - HWAEncode/Decode: VP8, HEVC 8b, VP9, HEVC 10b (For 7th Gen Intel® CPU)

- HWA Encode/Decode: VP8 , HEVC 8b; GPU/SWEncode/Decode: VP9, HEVC 10b (For 6th Gen Intel® CPU)

- Max. shared memory 1024MB

* The size of maximum shared memory may vary from different operating systems.

- Supports DVI-D with max. resolution up to 1920x1200 @ 60Hz
- Supports Accelerated Media Codecs: HEVC, VP8, VP9
- Supports HDCP with DVI-D Port
- Supports Full HD 1080p Blu-ray (BD) playback with DVI-D Port

Audio

- 7.1 CH HD Audio (Realtek ALC887 Audio Codec)

* To configure 7.1 CH HD Audio, it is required to use an HD front panel audio module and enable the multi-channel audio feature through the audio driver.

- Supports Surge Protection
- ELNA Audio Caps

LAN

- Gigabit LAN 10/100/1000 Mb/s
- Giga PHY Intel® I219V
- Supports Wake-On-LAN (Supported on Black PCIe Slots only)
- Supports Lightning/ESD Protection
- Supports Energy Efficient Ethernet 802.3az
- Supports PXE

Rear Panel I/O

- 1 x PS/2 Mouse Port
- 1 x PS/2 Keyboard Port
- 1 x DVI-D Port
- 4 x USB 2.0 Ports (Supports ESD Protection)
- 2 x USB 3.0 Ports (Supports ESD Protection)
- 1 x RJ-45 LAN Port with LED (ACT/LINK LED and SPEED LED)
- HD Audio Jacks: Line in / Front Speaker / Microphone

Storage

- 4 x SATA3 6.0 Gb/s Connectors, support NCQ, AHCI and Hot Plug*

* If M2_1 is occupied by a SATA-type M.2 device, SATA3_0 will be disabled.

- 1 x M.2 Socket, supports M Key type 2230/2242/2260/2280 M.2 SATA3 6.0 Gb/s module

Connector

- 1 x Print Port Header
- 1 x COM Port Header
- 1 x TPM Header
- 1 x Chassis Intrusion and Speaker Header
- 1 x CPU Fan Connector (4-pin)

* The CPU Fan Connector supports the CPU fan of maximum 1A (12W) fan power.

- 2 x Chassis Fan Connectors (4-pin)
- 1 x 24 pin ATX Power Connector
- 1 x 8 pin 12V Power Connector
- 2 x PCIe Power Connectors
- 1 x SATA Power Connector
- 1 x Front Panel Audio Connector
- 1 x USB 2.0 Header (Supports 2 USB 2.0 ports) (Supports ESD Protection)
- 1 x USB 3.0 Header (Supports 2 USB 3.0 ports) (Supports ESD Protection)

BIOS

Feature

- AMI UEFI Legal BIOS with multilingual GUI support
- ACPI 5.0 Compliant wake up events
- SMBIOS 2.7 Support
- CPU, DRAM, PCH 1.05V Voltage multi-adjustment

Hardware Monitor

- CPU/Chassis temperature sensing
- CPU/Chassis Fan Tachometer
- CPU/Chassis Quiet Fan (Auto adjust chassis fan speed by CPU temperature)
- CPU/Chassis Fan multi-speed control
- CASE OPEN detection
- Voltage monitoring: +12V, +5V, +3.3V, CPU Vcore

OS

- Microsoft® Windows® 10 64-bit (For 7th Gen Intel® CPU)
- Microsoft® Windows® 10 64-bit / 8.1 64-bit / 7 32-bit / 7 64-bit (For 6th Gen Intel® CPU)

* To install Windows® 7 OS, a modified installation disk with xHCI drivers packed into the ISO file is required. Please refer to page 34 or more detailed instructions.

* For the updated Windows® 10 driver, please visit ASRock's website for details: <http://www.asrock.com>

Certifications

- FCC, CE

* For detailed product information, please visit our website: <http://www.asrock.com>



Please realize that there is a certain risk involved with overclocking, including adjusting the setting in the BIOS, applying Untied Overclocking Technology, or using third-party overclocking tools. Overclocking may affect your system's stability, or even cause damage to the components and devices of your system. It should be done at your own risk and expense. We are not responsible for possible damage caused by overclocking.

1.3 Motherboard Layout

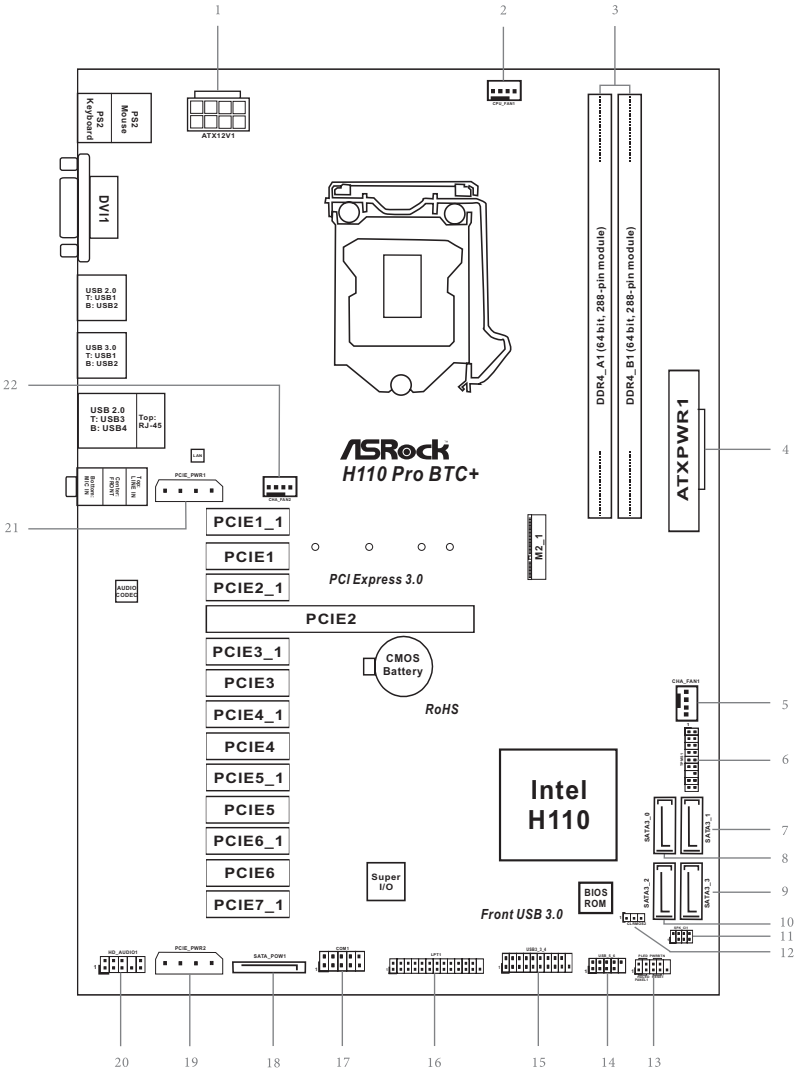

No.	Description
1	ATX 12V Power Connector (ATX12V1)
2	CPU Fan Connector (CPU_FAN1)
3	2 x 288-pin DDR4 DIMM Slots (DDR4_A1, DDR4_B1)
4	ATX Power Connector (ATXPWR1)
5	Chassis Fan Connector (CHA_FAN1)
6	TPM Header (TPMS1)
7	SATA3 Connector (SATA3_1)
8	SATA3 Connector (SATA3_0)
9	SATA3 Connector (SATA3_3)
10	SATA3 Connector (SATA3_2)
11	Chassis Intrusion and Speaker Header (SPK_C11)
12	Clear CMOS Jumper (CLRMOS2)
13	System Panel Header (PANEL1)
14	USB 2.0 Header (USB_5_6)
15	USB 3.0 Header (USB3_3_4)
16	Print Port Header (LPT1)
17	COM Port Header (COM1)
18	SATA Power Connector (SATA_POW1)
19	PCIe Power Connector (PCIE_PWR2)
20	Front Panel Audio Header (HD_AUDIO1)
21	PCIe Power Connector (PCIE_PWR1)
22	Chassis Fan Connector (CHA_FAN2)

1.4 I/O Panel

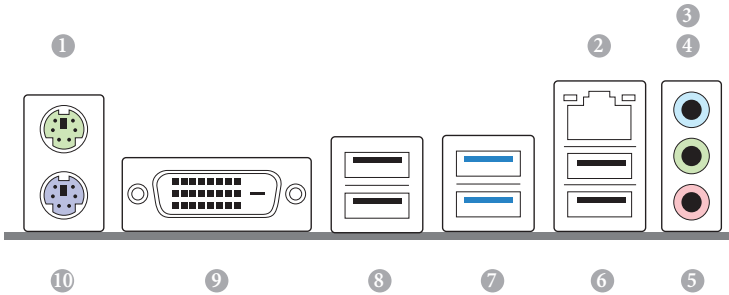

No.	Description	No.	Description
1	PS/2 Mouse Port	6	USB 2.0 Port (USB_34)
2	LAN RJ-45 Port*	7	USB 3.0 Ports (USB3_1_2)
3	Line In (Light Blue)**	8	USB 2.0 Port (USB_12)
4	Front Speaker (Lime)**	9	DVI-D Port
5	Microphone (Pink)**	10	PS/2 Keyboard Port

* There are two LEDs on the LAN port. Please refer to the table below for the LAN port LED indications.

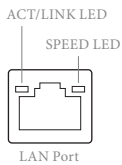

Activity / Link LED		Speed LED	
Status	Description	Status	Description
Off	No Link	Off	10Mbps connection
Blinking	Data Activity	Orange	100Mbps connection
On	Link	Green	1Gbps connection

** To configure 7.1 CH HD Audio, it is required to use an HD front panel audio module and enable the multi-channel audio feature through the audio driver.

Please set Speaker Configuration to "7.1 Speaker" in the Realtek HD Audio Manager.



Function of the Audio Ports in 7.1-channel Configuration:

Port	Function
Light Blue (Rear panel)	Rear Speaker Out
Lime (Rear panel)	Front Speaker Out
Pink (Rear panel)	Central /Subwoofer Speaker Out
Lime (Front panel)	Side Speaker Out

Chapter 2 Installation

This is an ATX form factor motherboard. Before you install the motherboard, study the configuration of your chassis to ensure that the motherboard fits into it.

Pre-installation Precautions

Take note of the following precautions before you install motherboard components or change any motherboard settings.

- Make sure to unplug the power cord before installing or removing the motherboard components. Failure to do so may cause physical injuries and damages to motherboard components.
- In order to avoid damage from static electricity to the motherboard's components, NEVER place your motherboard directly on a carpet. Also remember to use a grounded wrist strap or touch a safety grounded object before you handle the components.
- Hold components by the edges and do not touch the ICs.
- Whenever you uninstall any components, place them on a grounded anti-static pad or in the bag that comes with the components.
- When placing screws to secure the motherboard to the chassis, please do not over-tighten the screws! Doing so may damage the motherboard.

2.1 Installing the CPU



1. Before you insert the 1151-Pin CPU into the socket, please check if the **PnP cap** is on the socket, if the CPU surface is unclean, or if there are any **bent pins** in the socket. Do not force to insert the CPU into the socket if above situation is found. Otherwise, the CPU will be seriously damaged.
2. Unplug all power cables before installing the CPU.

1

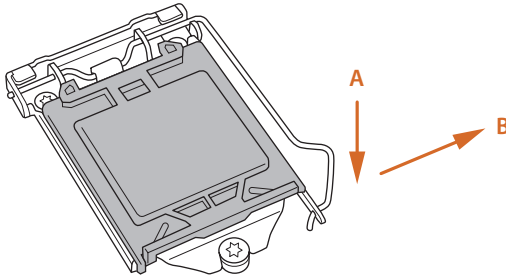

2

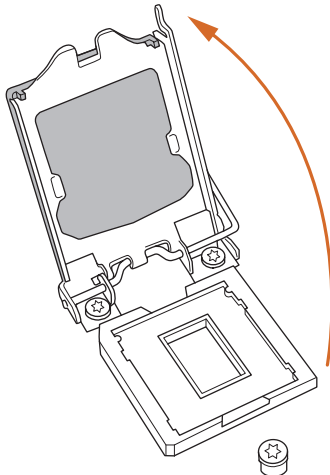

3

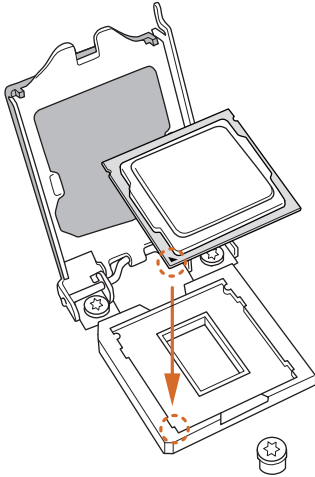

4

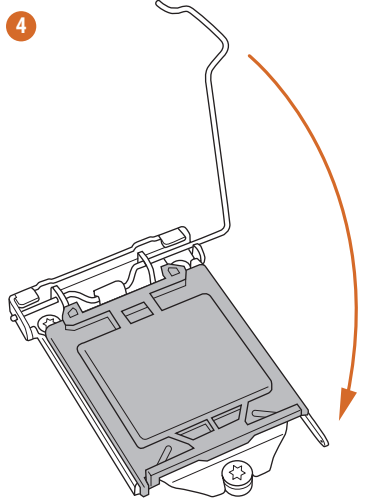

5

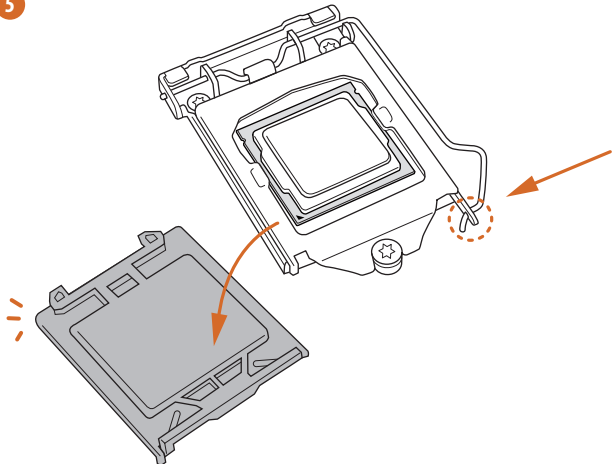



Please save and replace the cover if the processor is removed. The cover must be placed if you wish to return the motherboard for after service.

2.2 Installing the CPU Fan and Heatsink

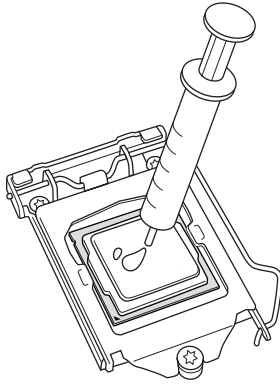

1

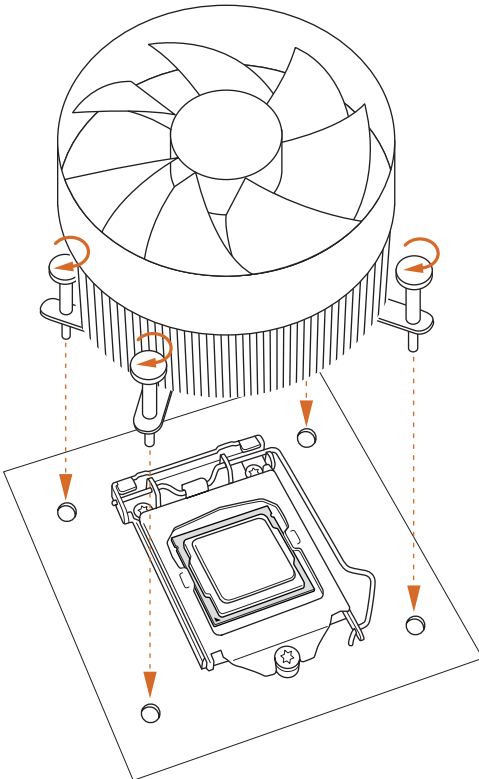

2

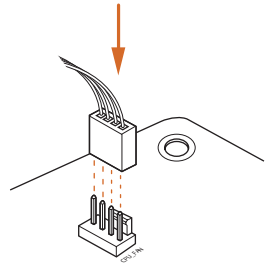

2.3 Installing Memory Modules (DIMM)

This motherboard provides two 288-pin DDR4 (Double Data Rate 4) DIMM slots, and supports Dual Channel Memory Technology.



1. For dual channel configuration, you always need to install identical (the same brand, speed, size and chip-type) DDR4 DIMM pairs.
2. It is unable to activate Dual Channel Memory Technology with only one memory module installed.
3. It is not allowed to install a DDR, DDR2 or DDR3 memory module into a DDR4 slot; otherwise, this motherboard and DIMM may be damaged.



The DIMM only fits in one correct orientation. It will cause permanent damage to the motherboard and the DIMM if you force the DIMM into the slot at incorrect orientation.

1

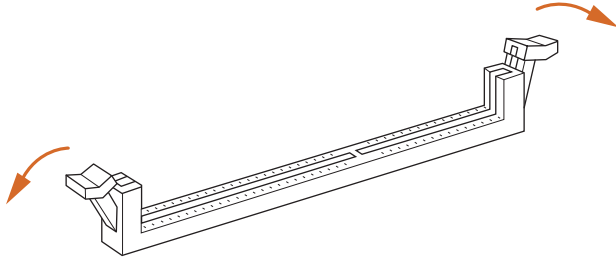

2

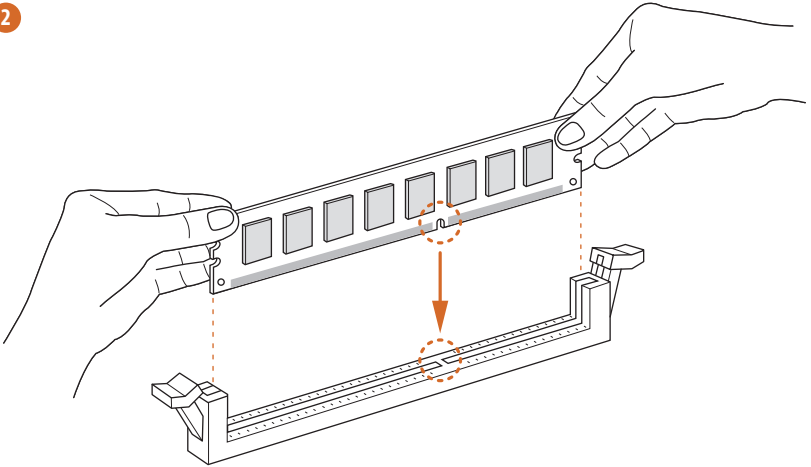

3

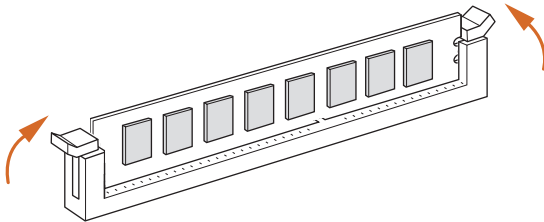

2.4 Expansion Slots (PCI Express Slots)

There are 13 PCI Express slots on the motherboard.



Before installing an expansion card, please make sure that the power supply is switched off or the power cord is unplugged. Please read the documentation of the expansion card and make necessary hardware settings for the card before you start the installation.

PCIe slots:

PCIE2 (PCIe 3.0 x16 slot) is used for PCI Express x16 lane width graphics cards.

PCIE1_1/PCIE1/PCIE2_1/PCIE3_1/PCIE3/PCIE4_1/PCIE4/PCIE5_1/PCIE5/
PCIE6_1/PCIE6/PCIE7_1 (PCIe 2.0 x1 slot) is used for PCI Express x1 lane width graphics cards.



- 1. Please connect the SATA power connector and PCIe power connectors to the power supply when three graphics cards are installed on this motherboard.*
- 2. 12V power supply can only provide 1.2A current in the white PCIe slots.*

2.5 Jumpers Setup

The illustration shows how jumpers are setup. When the jumper cap is placed on the pins, the jumper is “Short”. If no jumper cap is placed on the pins, the jumper is “Open”. The illustration shows a 3-pin jumper whose pin1 and pin2 are “Short” when a jumper cap is placed on these 2 pins.

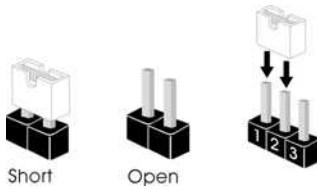

Clear CMOS Jumper
(CLRMOS2)
(see p.6, No. 12)

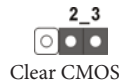

CLRMOS2 allows you to clear the data in CMOS. To clear and reset the system parameters to default setup, please turn off the computer and unplug the power cord from the power supply. After waiting for 15 seconds, use a jumper cap to short pin2 and pin3 on CLRMOS2 for 5 seconds. However, please do not clear the CMOS right after you update the BIOS. If you need to clear the CMOS when you just finish updating the BIOS, you must boot up the system first, and then shut it down before you do the clear-CMOS action. Please be noted that the password, date, time, and user default profile will be cleared only if the CMOS battery is removed.

2.6 Onboard Headers and Connectors



Onboard headers and connectors are NOT jumpers. Do NOT place jumper caps over these headers and connectors. Placing jumper caps over the headers and connectors will cause permanent damage to the motherboard.

System Panel Header
(9-pin PANEL1)
(see p.6, No. 13)

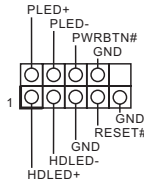

Connect the power switch, reset switch and system status indicator on the chassis to this header according to the pin assignments below. Note the positive and negative pins before connecting the cables.



PWRBTN (Power Switch):

Connect to the power switch on the chassis front panel. You may configure the way to turn off your system using the power switch.

RESET (Reset Switch):

Connect to the reset switch on the chassis front panel. Press the reset switch to restart the computer if the computer freezes and fails to perform a normal restart.

PLED (System Power LED):

Connect to the power status indicator on the chassis front panel. The LED is on when the system is operating. The LED keeps blinking when the system is in S1/S3 sleep state. The LED is off when the system is in S4 sleep state or powered off (S5).

HDLED (Hard Drive Activity LED):

Connect to the hard drive activity LED on the chassis front panel. The LED is on when the hard drive is reading or writing data.

The front panel design may differ by chassis. A front panel module mainly consists of power switch, reset switch, power LED, hard drive activity LED, speaker and etc. When connecting your chassis front panel module to this header, make sure the wire assignments and the pin assignments are matched correctly.

Chassis Intrusion and Speaker Header
(7-pin SPK_C11)
(see p.6, No. 11)

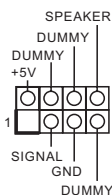

Please connect the chassis intrusion and the chassis speaker to this header.

Serial ATA3 Connectors

(SATA3_0:
see p.6, No. 8)
(SATA3_1:
see p.6, No. 7)
(SATA3_2:
see p.6, No. 10)
(SATA3_3:
see p.6, No. 9)

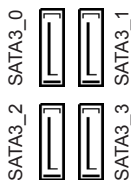

These four SATA3 connectors support SATA data cables for internal storage devices with up to 6.0 Gb/s data transfer rate. If M2_1 is occupied by a SATA-type M.2 device, SATA3_0 will be disabled.

SATA Power Connector

(SATA_POWER1)
(see p.6, No. 18)



Please connect this connector to the power supply when three graphics cards are installed on this motherboard.

USB 2.0 Header

(9-pin USB_5_6)
(see p.6, No. 14)

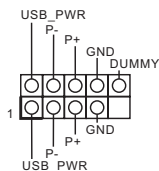

There is one header on this motherboard. This USB 2.0 header can support two ports.

USB 3.0 Header

(19-pin USB3_3_4)
(see p.6, No. 15)

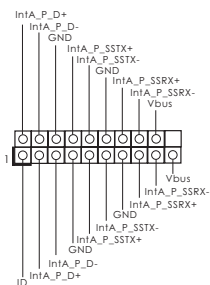

There is one header on this motherboard. This USB 3.0 header can support two ports.

Front Panel Audio Header

(9-pin HD_AUDIO1)
(see p.6, No. 20)

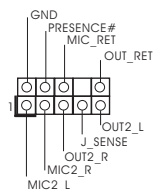

This header is for connecting audio devices to the front audio panel.



1. High Definition Audio supports Jack Sensing, but the panel wire on the chassis must support HDA to function correctly. Please follow the instructions in our manual and chassis manual to install your system.
2. If you use an AC'97 audio panel, please install it to the front panel audio header by the steps below:
 - A. Connect Mic_IN (MIC) to MIC2_L.
 - B. Connect Audio_R (RIN) to OUT2_R and Audio_L (LIN) to OUT2_L.
 - C. Connect Ground (GND) to Ground (GND).
 - D. MIC_RET and OUT_RET are for the HD audio panel only. You don't need to connect them for the AC'97 audio panel.
 - E. To activate the front mic, go to the "FrontMic" Tab in the Realtek Control panel and adjust "Recording Volume".

Chassis Fan Connectors

(4-pin CHA_FAN1)

(see p.6, No. 5)

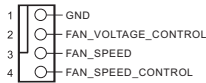

Please connect fan cables to the fan connector and match the black wire to the ground pin.

(4-pin CHA_FAN2)

(see p.6, No. 22)

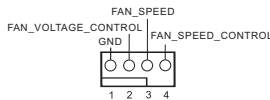

CPU Fan Connector

(4-pin CPU_FAN1)

(see p.6, No. 2)

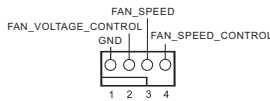

This motherboard provides a 4-Pin CPU fan (Quiet Fan) connector. If you plan to connect a 3-Pin CPU fan, please connect it to Pin 1-3.

ATX Power Connector

(24-pin ATXPWR1)

(see p.6, No. 4)

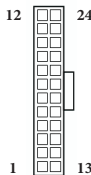

This motherboard provides a 24-pin ATX power connector. To use a 20-pin ATX power supply, please plug it along Pin 1 and Pin 13.

ATX 12V Power Connector

(8-pin ATX12V1)

(see p.6, No. 1)

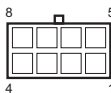

This motherboard provides an 8-pin ATX 12V power connector. To use a 4-pin ATX power supply, please plug it along Pin 1 and Pin 5.

PCIe Power Connectors
 (4-pin PCIE_PWR1)
 (see p.6, No. 21)
 (4-pin PCIE_PWR2)
 (see p.6, No. 19)

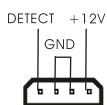

Please connect these connectors to the power supply when three graphics cards are installed on this motherboard. Please refer to page 23 for PCIe Power Connector Installation Guide.

Serial Port Header
 (9-pin COM1)
 (see p.6, No. 17)

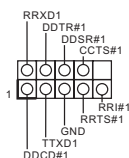

This COM1 header supports a serial port module.

TPM Header
 (17-pin TPMS1)
 (see p.6, No. 6)

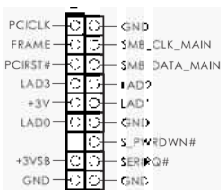

This connector supports Trusted Platform Module (TPM) system, which can securely store keys, digital certificates, passwords, and data. A TPM system also helps enhance network security, protects digital identities, and ensures platform integrity.

Print Port Header
 (25-pin LPT1)
 (see p.6, No. 16)

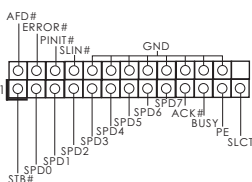

This is an interface for print port cable that allows convenient connection of printer devices.

2.7 PCIe Power Connector Installation Guide

The two extra 4-pin power connectors on this motherboard offer more power for your graphics cards. They provide stable voltages and greatly reduce the risks of burning your motherboard or graphics cards.

When more than three graphics cards are installed, be sure to install the PSU's 4-pin power cables to the 4-pin power connectors (PCIE_PWR) on your motherboard; otherwise, the cards may be damaged.

Please **MUST** install **TWO** PSU's 4-pin power cables to your MB's **TWO** 4-pin power connectors. Plug one of the PSU's 4-pin power connector (1) to the 4-pin power connector closer to the PCIe x16 slot (A PCIE_PWR1).

Then plug another PSU's 4-pin power connector (2) to the other 4-pin power connector (B PCIE_PWR2).

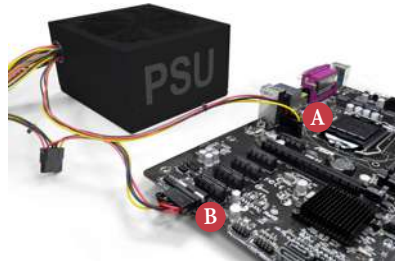
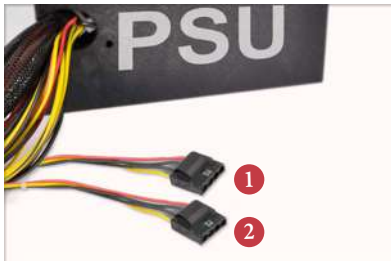

If your PSU only provides ONE, then please **MUST** install it to the 4-pin power connector (PCIE_PWR1) closer to the PCIe x16 slot.



Important: Besides the two PCIe power connectors, please connect the SATA power connector as well when you install more than three graphics cards. Make sure all the connected power connectors (4-pin, 24-pin and SATA) are on the same PSU; otherwise, the motherboard may be damaged.

**The diagrams shown here are for reference only. Please refer to the user manual that comes with your motherboard for the accurate location of the 4-pin power connectors.*

2.8 M.2_SSD (NGFF) Module Installation Guide

The M.2, also known as the Next Generation Form Factor (NGFF), is a small size and versatile card edge connector that aims to replace mPCIe and mSATA. The M.2 Socket (M2_1) supports M Key type 2230/2242/2260/2280 M.2 SATA3 6.0 Gb/s module.

* Please be noted that if M2_1 is occupied by a SATA-type M.2 device, SATA3_0 will be disabled.

Installing the M.2_SSD (NGFF) Module

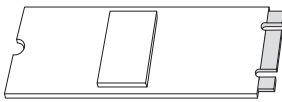

Step 1

Prepare a M.2_SSD (NGFF) module and the screw.

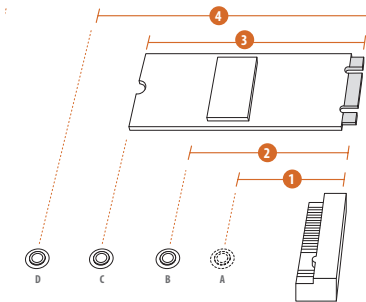

Step 2

Depending on the PCB type and length of your M.2_SSD (NGFF) module, find the corresponding nut location to be used.

No.	1	2	3	4
Nut Location	A	B	C	D
PCB Length	3cm	4.2cm	6cm	8cm
Module Type	Type2230	Type 2242	Type2260	Type 2280

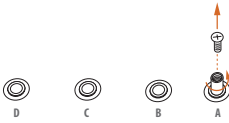
Step 3

Move the standoff based on the module type and length.

The standoff is placed at the nut location A by default. Skip Step 3 and 4 and go straight to Step 5 if you are going to use the default nut.

Otherwise, release the standoff by hand.

Step 4

Peel off the yellow protective film on the nut to be used. Hand tighten the standoff into the desired nut location on the motherboard.

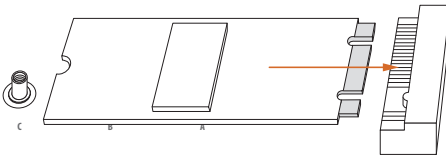
Step 5

Align and gently insert the M.2 (NGFF) SSD module into the M.2 slot. Please be aware that the M.2 (NGFF) SSD module only fits in one orientation.

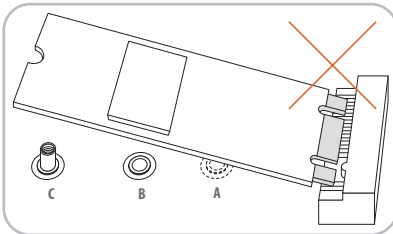

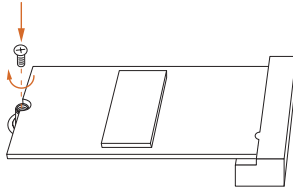

Step 6

Tighten the screw with a screwdriver to secure the module into place. Please do not overtighten the screw as this might damage the module.

M.2_SSD (NGFF) Module Support List

Vendor	Interface	P/N
ADATA	SATA	ADATA - AXNS381E-128GM-B
Crucial	SATA	Crucial-CT240M500SSD4-240GB
EZLINK	SATA	EZLINK P51B-80-120GB
Intel	SATA	INTEL 540S-SSDSCKKW240H6-240GB
Kingston	SATA	Kingston-RBU-SNS8400S3 / 180GD
Kingston	SATA	Kingston SM2280S3G2/120G - Win8.1
LITEON	SATA	LITEON LJH-256V2G-256GB (2260)
PLEXTOR	SATA	PLEXTOR PX-128M7VG-128GB
PLEXTOR	SATA	PLEXTOR PX-128M6G-2260-128GB
SanDisk	SATA	SanDisk-SD6SN1M-128G
SanDisk	SATA	SanDisk X400-SD8SN8U-128G
SanDisk	SATA	Sandisk Z400s-SD8SNAT-128G-1122
Transcend	SATA	Transcend TS256GMTS800-256GB
Transcend	SATA	Transcend TS64GMTS400-64GB
V-Color	SATA	V-Color 120G
V-Color	SATA	V-Color 240G
WD	SATA	WD BLUE WDS100T1B0B-00AS40
WD	SATA	WD GREEN WDS240G1G0B-00RC30

For the latest updates of M.2_SSD (NFGG) module support list, please visit our website for details: <http://www.asrock.com>

Chapter 3 Software and Utilities Operation

3.1 Installing Drivers

The Support CD that comes with the motherboard contains necessary drivers and useful utilities that enhance the motherboard's features.

Running The Support CD

To begin using the support CD, insert the CD into your CD-ROM drive. The CD automatically displays the Main Menu if "AUTORUN" is enabled in your computer. If the Main Menu does not appear automatically, locate and double click on the file "ASRSETUP.EXE" in the Support CD to display the menu.

Drivers Menu

The drivers compatible to your system will be auto-detected and listed on the support CD driver page. Please click **Install All** or follow the order from top to bottom to install those required drivers. Therefore, the drivers you install can work properly.

Utilities Menu

The Utilities Menu shows the application software that the motherboard supports. Click on a specific item then follow the installation wizard to install it.



To improve Windows 7 compatibility, please download and install the following hot fix provided by Microsoft.

"KB2720599": <http://support.microsoft.com/kb/2720599/en-us>

3.2 ASRock Live Update & APP Shop

The ASRock Live Update & APP Shop is an online store for purchasing and downloading software applications for your ASRock computer. You can quickly and easily install various apps and support utilities. With ASRock Live Update & APP Shop, you can optimize your system and keep your motherboard up to date simply with a few clicks.

Double-click  on your desktop to access ASRock Live Update & APP Shop utility.

**You need to be connected to the Internet to download apps from the ASRock Live Update & APP Shop.*

3.2.1 UI Overview

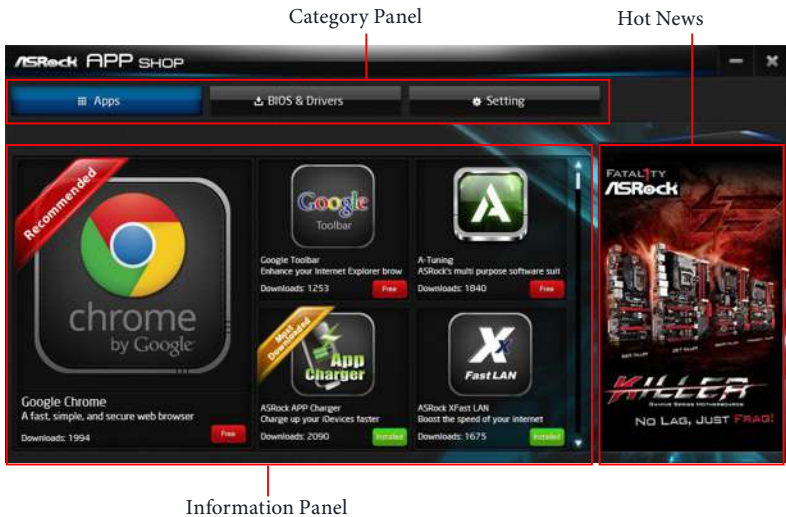

Category Panel: The category panel contains several category tabs or buttons that when selected the information panel below displays the relative information.

Information Panel: The information panel in the center displays data about the currently selected category and allows users to perform job-related tasks.

Hot News: The hot news section displays the various latest news. Click on the image to visit the website of the selected news and know more.

3.2.2 Apps

When the "Apps" tab is selected, you will see all the available apps on screen for you to download.

Installing an App

Step 1

Find the app you want to install.



The most recommended app appears on the left side of the screen. The other various apps are shown on the right. Please scroll up and down to see more apps listed.

You can check the price of the app and whether you have already installed it or not.

Free - The red icon displays the price or "Free" if the app is free of charge.

Installed - The green "Installed" icon means the app is installed on your computer.

Step 2

Click on the app icon to see more details about the selected app.

Step 3

If you want to install the app, click on the red icon  to start downloading.



Step 4

When installation completes, you can find the green "Installed" icon appears on the upper right corner.



To uninstall it, simply click on the trash can icon .

*The trash icon may not appear for certain apps.

Upgrading an App

You can only upgrade the apps you have already installed. When there is an available new version for your app, you will find the mark of "New Version"  appears below the installed app icon.



Step 1

Click on the app icon to see more details.

Step 2

Click on the yellow icon  to start upgrading.

3.2.3 BIOS & Drivers

Installing BIOS or Drivers

When the "BIOS & Drivers" tab is selected, you will see a list of recommended or critical updates for the BIOS or drivers. Please update them all soon.

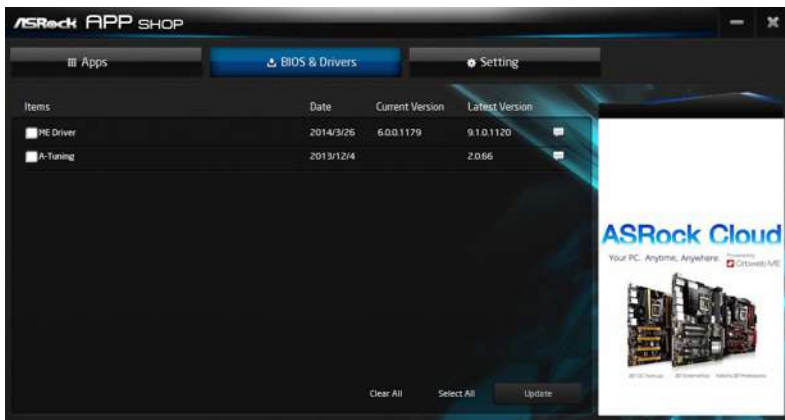

Step 1

Please check the item information before update. Click on  to see more details.

Step 2

Click to select one or more items you want to update.

Step 3

Click Update to start the update process.

3.2.4 Setting

In the "Setting" page, you can change the language, select the server location, and determine if you want to automatically run the ASRock Live Update & APP Shop on Windows startup.

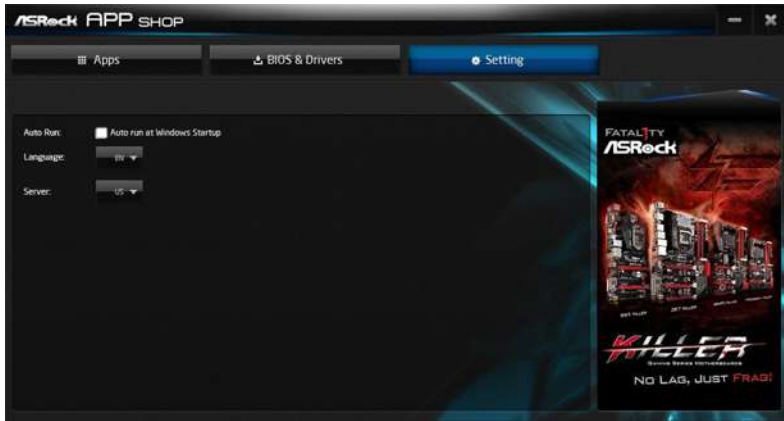

3.3 Enabling USB Ports for Windows® 7 Installation

Intel® Braswell and Skylake has removed their support for the Enhanced Host Controller Interface (EHCI – USB2.0) and only kept the eXtensible Host Controller Interface (XHCI – USB3.0). Due to that fact that XHCI is not included in the Windows 7 inbox drivers, users may find it difficult to install Windows 7 operating system because the USB ports on their motherboard won't work. In order for the USB ports to function properly, please create a Windows® 7 installation disk with the Intel® USB 3.0 eXtensible Host Controller (xHCI) drivers packed into the ISO file.

Requirements

- A Windows® 7 installation disk or USB drive
- USB 3.0 drivers (included in the ASRock Support CD or website)
- A Windows® PC
- Win7 USB Patcher (included in the ASRock Support CD or website)

Scenarios

You have an ODD and PS/2 ports:

If there is an optical disc drive, PS/2 ports and PS/2 Keyboard or mouse on your computer, you can skip the instructions below and go ahead to install Windows® 7 OS.

You only have an ODD (*For Intel Skylake platforms only*):

If there is an optical disc drive but no PS/2 ports on your computer, please enable the “PS/2 Simulator” option in *UEFI SETUP UTILITY > Advanced > USB Configuration*, which allows the USB port to function as a PS/2 port, and then you can install the Windows® 7 OS. Please set PS/S Simulator back to disabled after the installation.

You've got nothing:

If you do not have an optical disc drive, please find another computer and follow the instructions below to create a new ISO file with the “Win7 USB Patcher”. Then use the new patched Windows® 7 installation USB drive to install Windows® 7 OS.

Instructions

Step 1

Insert the Windows® 7 installation disk or USB drive to your system.

Step 2

Extract the tool (Win7 USB Patcher) and launch it.

Step 3

Select the “Win7 Folder” from Step1 by clicking the red circle as shown as the picture below.



Step 4

Select the “USB Driver Folder” by clicking the red circle as shown as the picture below.



If you are using ASRock’s Support CD for the USB 3.0 driver, please select your CD-ROM.

Step 5

Select where to save the ISO file by pressing the red circle as shown as the picture below.



Step 6

If you want to burn the patched image to a CD, please check “Burn Image” and select “Target Device to Burn”. If not, the patched ISO image will be exported to the destination selected in Step5. Then Press “Start” to proceed.

Step 7

Now you are able to install Windows® 7 on Braswell or Skylake with the new burned CD. Or please use the patched ISO image to make an OS USB drive to install the OS.

Chapter 4 UEFI SETUP UTILITY

4.1 Introduction

This section explains how to use the UEFI SETUP UTILITY to configure your system. You may run the UEFI SETUP UTILITY by pressing <F2> or right after you power on the computer, otherwise, the Power-On-Self-Test (POST) will continue with its test routines. If you wish to enter the UEFI SETUP UTILITY after POST, restart the system by pressing <Ctl> + <Alt> + <Delete>, or by pressing the reset button on the system chassis. You may also restart by turning the system off and then back on.



Because the UEFI software is constantly being updated, the following UEFI setup screens and descriptions are for reference purpose only, and they may not exactly match what you see on your screen.

4.1.1 UEFI Menu Bar

The top of the screen has a menu bar with the following selections:

Main	For setting system time/date information
OC Tweaker	For overclocking configurations
Advanced	For advanced system configurations
Tool	Useful tools
H/W Monitor	Displays current hardware status
Security	For security settings
Boot	For configuring boot settings and boot priority
Exit	Exit the current screen or the UEFI Setup Utility

4.1.2 Navigation Keys

Use <←> key or <→> key to choose among the selections on the menu bar, and use <↑> key or <↓> key to move the cursor up or down to select items, then press <Enter> to get into the sub screen. You can also use the mouse to click your required item.

Please check the following table for the descriptions of each navigation key.

Navigation Key(s)	Description
+ / -	To change option for the selected items
<Tab>	Switch to next function
<PGUP>	Go to the previous page
<PGDN>	Go to the next page
<HOME>	Go to the top of the screen
<END>	Go to the bottom of the screen
<F1>	To display the General Help Screen
<F5>	Add / Remove Favorite
<F7>	Discard changes and exit the SETUP UTILITY
<F9>	Load optimal default values for all the settings
<F10>	Save changes and exit the SETUP UTILITY
<F12>	Print screen
<ESC>	Jump to the Exit Screen or exit the current screen

4.2 Main Screen

When you enter the UEFI SETUP UTILITY, the Main screen will appear and display the system overview.



4.3 OC Tweaker Screen

In the OC Tweaker screen, you can set up overclocking features.



Because the UEFI software is constantly being updated, the following UEFI setup screens and descriptions are for reference purpose only, and they may not exactly match what you see on your screen.

CPU Configuration

Intel SpeedStep Technology

Intel SpeedStep technology allows processors to switch between multiple frequencies and voltage points for better power saving and heat dissipation.

Intel Turbo Boost Technology

Intel Turbo Boost Technology enables the processor to run above its base operating frequency when the operating system requests the highest performance state.

Long Duration Power Limit

Configure Package Power Limit 1 in watts. When the limit is exceeded, the CPU ratio will be lowered after a period of time. A lower limit can protect the CPU and save power, while a higher limit may improve performance.

Long Duration Maintained

Configure the period of time until the CPU ratio is lowered when the Long Duration Power Limit is exceeded.

Short Duration Power Limit

Configure Package Power Limit 2 in watts. When the limit is exceeded, the CPU ratio will be lowered immediately. A lower limit can protect the CPU and save power, while a higher limit may improve performance.

DRAM Timing Configuration

Load XMP Setting

Load XMP settings to overclock the memory and perform beyond standard specifications.

DRAM Reference Clock

Select Auto for optimized settings.

DRAM Frequency

If [Auto] is selected, the motherboard will detect the memory module(s) inserted and assign the appropriate frequency automatically.

Primary Timing

CAS# Latency (tCL)

The time between sending a column address to the memory and the beginning of the data in response.

RAS# to CAS# Delay and Row Precharge (tRCDtRP)

RAS# to CAS# Delay : The number of clock cycles required between the opening of a row of memory and accessing columns within it.

Row Precharge: The number of clock cycles required between the issuing of the precharge command and opening the next row.

RAS# Active Time (tRAS)

The number of clock cycles required between a bank active command and issuing the precharge command.

Command Rate (CR)

The delay between when a memory chip is selected and when the first active command can be issued.

Secondary Timing

Write Recovery Time (tWR)

The amount of delay that must elapse after the completion of a valid write operation, before an active bank can be precharged.

Refresh Cycle Time (tRFC)

The number of clocks from a Refresh command until the first Activate command to the same rank.

RAS to RAS Delay (tRRD_L)

The number of clocks between two rows activated in different banks of the same rank.

RAS to RAS Delay (tRRD_S)

The number of clocks between two rows activated in different banks of the same rank.

Write to Read Delay (tWTR_L)

The number of clocks between the last valid write operation and the next read command to the same internal bank.

Write to Read Delay (tWTR_S)

The number of clocks between the last valid write operation and the next read command to the same internal bank.

Read to Precharge (tRTP)

The number of clocks that are inserted between a read command to a row precharge command to the same rank.

Four Activate Window (tFAW)

The time window in which four activates are allowed the same rank.

CAS Write Latency (tCWL)

Configure CAS Write Latency.

Third Timing

tREFI

Configure refresh cycles at an average periodic interval.

tCKE

Configure the period of time the DDR4 initiates a minimum of one refresh command internally once it enters Self-Refresh mode.

tRDRD_sg

Configure between module read to read delay.

tRDRD_dg

Configure between module read to read delay.

tRDRD_dr

Configure between module read to read delay.

tRDRD_dd

Configure between module read to read delay.

tRDWR_sg

Configure between module read to write delay.

tRDWR_dg

Configure between module read to write delay.

tRDWR_dr

Configure between module read to write delay.

tRDWR_dd

Configure between module read to write delay.

tWRRD_sg

Configure between module write to read delay.

tWRRD_dg

Configure between module write to read delay.

tWRRD_dr

Configure between module write to read delay.

tWRRD_dd

Configure between module write to read delay.

tWRWR_sg

Configure between module write to write delay.

tWRWR_dg

Configure between module write to write delay.

tWRWR_dr

Configure between module write to write delay.

tWRWR_dd

Configure between module write to write delay.

RTL Init Value

Configure round trip latency init value for round trip latency training.

IO-L Init Value

Configure IO latency init value for IO latency training.

RTL (CH A)

Configure round trip latency for channel A.

RTL (CH B)

Configure round trip latency for channel B.

IO-L (CH A)

Configure IO latency for channel A.

IO-L (CH B)

Configure IO latency for channel B.

IO-L Offset (CH A)

Configure IO latency offset for channel A.

IO-L Offset (CH B)

Configure IO latency offset for channel B.

RFR Delay (CH A)

Configure RFR Delay for Channel A.

RFR Delay (CH B)

Configure RFR Delay for Channel B.

Fourth Timing

twRPRE

Configure twRPRE.

Write_Early_ODT

Configure Write_Early_ODT.

tAONPD

Configure tAONPD.

tXP

Configure tXP.

tXPDLL

Configure tXPDLL.

tPRPDEN

Configure tPRPDEN.

tRDPDEN

Configure tRDPDEN.

twRPDEN

Configure twRPDEN.

OREF_RI

Configure OREF_RI.

tREFIx9

Configure tREFIx9.

txSDLL

Configure txSDLL.

txs_offset

Configure txs_offset.

tZQOPER

Configure tZQOPER.

tMOD

Configure tMOD.

ZQCS_period

Configure ZQCS_period.

tZQCS

Configure tZQCS.

Advanced Setting

ODT WR (CH A)

Configure the memory on die termination resistors' WR for channel A.

ODT WR (CH B)

Configure the memory on die termination resistors' WR for channel B.

ODT PARK (CH A)

Configure the memory on die termination resistors' PARK for channel A.

ODT PARK (CH B)

Configure the memory on die termination resistors' PARK for channel B.

ODT NOM (CH A)

Use this to change ODT (CH A) Auto/Manual settings. The default is [Auto].

ODT NOM (CH B)

Use this to change ODT (CH B) Auto/Manual settings. The default is [Auto].

MRC Fast Boot

Enable Memory Fast Boot to skip DRAM memory training for booting faster.

Dll Bandwidth 0

Configure the Dll Bandwidth 0.

Dll Bandwidth 1

Configure the Dll Bandwidth 1.

Dll Bandwidth 2

Configure the Dll Bandwidth 2.

Dll Bandwidth 3

Configure the Dll Bandwidth 3.

Margin Limit

Adjust Margin Limit to get better memory margin.

Voltage Configuration

DRAM Voltage

Use this to configure DRAM Voltage. The default value is [Auto].

PCH Voltage

Configure the chipset voltage (1.0V).

VCCIO Voltage

Configure the voltage for the VCCIO.

Save User Default

Type a profile name and press enter to save your settings as user default.

Load User Default

Load previously saved user defaults.

Save User UEFI Setup Profile to Disk

Save current UEFI settings as an user default profile to disk.

Load User UEFI Setup Profile from Disk

Load previously saved user defaults from the disk.

4.4 Advanced Screen

In this section, you may set the configurations for the following items: CPU Configuration, Chipset Configuration, Storage Configuration, Super IO Configuration, ACPI Configuration, USB Configuration and Trusted Computing.



Setting wrong values in this section may cause the system to malfunction.

4.4.1 CPU Configuration



Active Processor Cores

Select the number of cores to enable in each processor package.

CPU C States Support

Enable CPU C States Support for power saving. It is recommended to keep C3, C6 and C7 all enabled for better power saving.

Enhanced Halt State (C1E)

Enable Enhanced Halt State (C1E) for lower power consumption.

CPU C3 State Support

Enable C3 sleep state for lower power consumption.

CPU C6 State Support

Enable C6 deep sleep state for lower power consumption.

CPU C7 State Support

Enable C7 deep sleep state for lower power consumption.

Package C State Support

Enable CPU, PCIe, Memory, Graphics C State Support for power saving.

CFG Lock

This item allows you to disable or enable the CFG Lock.

CPU Thermal Throttling

Enable CPU internal thermal control mechanisms to keep the CPU from overheating.

No-Execute Memory Protection

Processors with No-Execution Memory Protection Technology may prevent certain classes of malicious buffer overflow attacks.

Intel Virtualization Technology

Intel Virtualization Technology allows a platform to run multiple operating systems and applications in independent partitions, so that one computer system can function as multiple virtual systems.

Hardware Prefetcher

Automatically prefetch data and code for the processor. Enable for better performance.

Adjacent Cache Line Prefetch

Automatically prefetch the subsequent cache line while retrieving the currently requested cache line. Enable for better performance.

SW Guard Extensions (SGX)

Intel SGX is a set of new CPU instructions that can be used by applications to set aside private regions of code and data.

4.4.2 Chipset Configuration



Primary Graphics Adapter

Select a primary VGA.

Above 4GB MMIO BIOS assignment

Use this to enable/disable above 4GB MemoryMappedIO BIOS assignment. This is disabled automatically when Aperture Size is set to 2048MB.

*Before installing Win7 32-bit OS, set “Above 4G” to [Disable] in BIOS to get the OS installed successfully. After installing Win7 32-bit OS, still do not set “Above 4G” to [Enable]. Setting to [Enable] will cause failure to enter OS. However, if “Above 4G” is set to [Disable] in BIOS, the number of graphic cards in use will be limited to two in maximum, which means users should avoid using Win7 32-bit OS to mine.

VT-d

Intel® Virtualization Technology for Directed I/O helps your virtual machine monitor better utilize hardware by improving application compatibility and reliability, and providing additional levels of manageability, security, isolation, and I/O performance.

PCIe1 Link Speed

Select the link speed for PCIe1.

PCIe2 Link Speed

Select the link speed for PCIE2.

PCIE3 Link Speed

Select the link speed for PCIE3.

PCIE4 Link Speed

Select the link speed for PCIE4.

PCIE5 Link Speed

Select the link speed for PCIE5.

PCIE6 Link Speed

Select the link speed for PCIE6.

PCIE7 Link Speed

Select the link speed for PCIE7.

PCIE ASPM Support

This option enables/disables the ASPM support for all CPU downstream devices.

PCH PCIE ASPM Support

This option enables/disables the ASPM support for all PCH PCIE devices.

DMI ASPM Support

This option enables/disables the control of ASPM on CPU side of the DMI Link.

PCH DMI ASPM Support

This option enables/disables the ASPM support for all PCH DMI devices.

IOAPIC 24-119 Entries

I/O APICs contain a redirection table, which is used to route the interrupts it receives from peripheral buses to one or more local APICs. Enable/disable IOAPIC 24-119 Entries to expand to PIROI-PIROX.

Share Memory

Configure the size of memory that is allocated to the integrated graphics processor when the system boots up.

IGPU Multi-Monitor

Select disable to disable the integrated graphics when an external graphics card is installed.

Select enable to keep the integrated graphics enabled at all times.

Onboard LAN

Enable or disable the onboard network interface controller.

Onboard HD Audio

Enable/disable onboard HD audio. Set to Auto to enable onboard HD audio and automatically disable it when a sound card is installed.

Front Panel

Select Front Panel type.

Onboard HDMI HD Audio

Enable audio for the onboard digital outputs.

Restore on AC/Power Loss

Select the power state after a power failure. If [Power Off] is selected, the power will remain off when the power recovers. If [Power On] is selected, the system will start to boot up when the power recovers.

4.4.3 Storage Configuration



SATA Controller(s)

Enable/disable the SATA controllers.

SATA Aggressive Link Power Management

SATA Aggressive Link Power Management allows SATA devices to enter a low power state during periods of inactivity to save power. It is only supported by AHCI mode.

Hard Disk S.M.A.R.T.

S.M.A.R.T stands for Self-Monitoring, Analysis, and Reporting Technology. It is a monitoring system for computer hard disk drives to detect and report on various indicators of reliability.

4.4.4 Super IO Configuration



Serial Port

Enable or disable the Serial port.

Serial Port Address

Select the address of the Serial port.

Parallel Port

Enable or disable the Parallel port.

Change Settings

Select the address of the Parallel port.

Device Mode

Select the device mode according to your connected device.

4.4.5 ACPI Configuration



Suspend to RAM

Select disable for ACPI suspend type S1. It is recommended to select auto for ACPI S3 power saving.

ACPI HEPT Table

Enable the High Precision Event Timer for better performance.

PS/2 Keyboard Power On

Allow the system to be waked up by a PS/2 Keyboard.

PCIe Devices Power On

Allow the system to be waked up by a PCIe device and enable wake on LAN.

Ring-In Power On

Allow the system to be waked up by onboard COM port modem Ring-In signals.

RTC Alarm Power On

Allow the system to be waked up by the real time clock alarm. Set it to By OS to let it be handled by your operating system.

USB Keyboard/Remote Power On

Allow the system to be waked up by an USB keyboard or remote controller.

USB Mouse Power On

Allow the system to be waked up by an USB mouse.

4.4.6 USB Configuration



Legacy USB Support

Enable or disable Legacy OS Support for USB 2.0 devices. If you encounter USB compatibility issues it is recommended to disable legacy USB support. Select UEFI Setup Only to support USB devices under the UEFI setup and Windows/Linux operating systems only.

PS/2 Simulator

Enable PS/2 Simulator. This should be enabled for the complete USB keyboard legacy support for non-USB aware OSes.

*Enable this option if you install Windows 7.

XHCI Hand-off

This is a workaround for OSes without XHCI hand-off support. The XHCI ownership change should be claimed by XHCI driver.

4.6.7 Trusted Computing



Security Device Support

Enable or disable BIOS support for security device.

4.5 Tools



Instant Flash

Save UEFI files in your USB storage device and run Instant Flash to update your UEFI.

4.6 Hardware Health Event Monitoring Screen

This section allows you to monitor the status of the hardware on your system, including the parameters of the CPU temperature, motherboard temperature, fan speed and voltage.



CPU Fan 1 Setting

Select a fan mode for CPU Fan 1, or choose Customize to set 5 CPU temperatures and assign a respective fan speed for each temperature.

Chassis Fan 1 Setting

Select a fan mode for Chassis Fan 1, or choose Customize to set 5 CPU temperatures and assign a respective fan speed for each temperature.

Chassis Fan 1 Temp Source

Select a fan temperature source for Chassis Fan 1.

Chassis Fan 2 Setting

Select a fan mode for Chassis Fan 2, or choose Customize to set 5 CPU temperatures and assign a respective fan speed for each temperature.

Chassis Fan 2 Temp Source

Select a fan temperature source for Chassis Fan 2.

Over Temperature Protection

When Over Temperature Protection is enabled, the system automatically shuts down when the motherboard is overheated.

Case Open Feature

Enable or disable Case Open Feature to detect whether the chassis cover has been removed.

4.7 Security Screen

In this section you may set or change the supervisor/user password for the system. You may also clear the user password.



Supervisor Password

Set or change the password for the administrator account. Only the administrator has authority to change the settings in the UEFI Setup Utility. Leave it blank and press enter to remove the password.

User Password

Set or change the password for the user account. Users are unable to change the settings in the UEFI Setup Utility. Leave it blank and press enter to remove the password.

Secure Boot

Use this item to enable or disable support for Windows 8.1 Secure Boot.

Intel(R) Platform Trust Technology

Enable/disable Intel PTT in ME. Disable this option to use discrete TPM Module.

4.8 Boot Screen

This section displays the available devices on your system for you to configure the boot settings and the boot priority.



Fast Boot

Fast Boot minimizes your computer's boot time. In fast mode you may not boot from an USB storage device. Ultra Fast mode is only supported by Windows 8.1 and the VBIOS must support UEFI GOP if you are using an external graphics card. Please notice that Ultra Fast mode will boot so fast that the only way to enter this UEFI Setup Utility is to Clear CMOS or run the Restart to UEFI utility in Windows.

Boot From Onboard LAN

Allow the system to be waked up by the onboard LAN.

Setup Prompt Timeout

Configure the number of seconds to wait for the setup hot key.

Bootup Num-Lock

Select whether Num Lock should be turned on or off when the system boots up.

Boot Beep

Select whether the Boot Beep should be turned on or off when the system boots up. Please note that a buzzer is needed.

Full Screen Logo

Enable to display the boot logo or disable to show normal POST messages.

AddOn ROM Display

Enable AddOn ROM Display to see the AddOn ROM messages or configure the AddOn ROM if you've enabled Full Screen Logo. Disable for faster boot speed.

Boot Failure Guard Message

If the computer fails to boot for a number of times the system automatically restores the default settings.

CSM (Compatibility Support Module)



CSM

Enable to launch the Compatibility Support Module. Please do not disable unless you're running a WHCK test. If you are using Windows 8.1 64-bit and all of your devices support UEFI, you may also disable CSM for faster boot speed.

Launch PXE OpROM Policy

Select UEFI only to run those that support UEFI option ROM only. Select Legacy only to run those that support legacy option ROM only. Select Do not launch to not execute both legacy and UEFI option ROM.

Launch Storage OpROM Policy

Select UEFI only to run those that support UEFI option ROM only. Select Legacy only to run those that support legacy option ROM only. Select Do not launch to not execute both legacy and UEFI option ROM.

Launch Video OpROM Policy

Select UEFI only to run those that support UEFI option ROM only. Select Legacy only to run those that support legacy option ROM only. Select Do not launch to not execute both legacy and UEFI option ROM.

4.9 Exit Screen



Save Changes and Exit

When you select this option the following message, “Save configuration changes and exit setup?” will pop out. Select [OK] to save changes and exit the UEFI SETUP UTILITY.

Discard Changes and Exit

When you select this option the following message, “Discard changes and exit setup?” will pop out. Select [OK] to exit the UEFI SETUP UTILITY without saving any changes.

Discard Changes

When you select this option the following message, “Discard changes?” will pop out. Select [OK] to discard all changes.

Load UEFI Defaults

Load UEFI default values for all options. The F9 key can be used for this operation.

Launch EFI Shell from filesystem device

Copy shellx64.efi to the root directory to launch EFI Shell.

Contact Information

If you need to contact ASRock or want to know more about ASRock, you're welcome to visit ASRock's website at <http://www.asrock.com>; or you may contact your dealer for further information. For technical questions, please submit a support request form at <http://www.asrock.com/support/tsd.asp>

ASRock Incorporation

2F., No.37, Sec. 2, Jhongyang S. Rd., Beitou District,

Taipei City 112, Taiwan (R.O.C.)

ASRock EUROPE B.V.

Bijsterhuizen 11-11

6546 AR Nijmegen

The Netherlands

Phone: +31-24-345-44-33

Fax: +31-24-345-44-38

ASRock America, Inc.

13848 Magnolia Ave, Chino, CA91710

U.S.A.

Phone: +1-909-590-8308

Fax: +1-909-590-1026