



ALiveNF5-eSATA2+

User Manual

Version 1.0

Published January 2007

Copyright©2007 ASRock INC. All rights reserved.

Copyright Notice:

No part of this manual may be reproduced, transcribed, transmitted, or translated in any language, in any form or by any means, except duplication of documentation by the purchaser for backup purpose, without written consent of ASRock Inc.

Products and corporate names appearing in this manual may or may not be registered trademarks or copyrights of their respective companies, and are used only for identification or explanation and to the owners' benefit, without intent to infringe.

Disclaimer:

Specifications and information contained in this manual are furnished for informational use only and subject to change without notice, and should not be constructed as a commitment by ASRock. ASRock assumes no responsibility for any errors or omissions that may appear in this manual.

With respect to the contents of this manual, ASRock does not provide warranty of any kind, either expressed or implied, including but not limited to the implied warranties or conditions of merchantability or fitness for a particular purpose.

In no event shall ASRock, its directors, officers, employees, or agents be liable for any indirect, special, incidental, or consequential damages (including damages for loss of profits, loss of business, loss of data, interruption of business and the like), even if ASRock has been advised of the possibility of such damages arising from any defect or error in the manual or product.



This device complies with Part 15 of the FCC Rules. Operation is subject to the following two conditions:

- (1) this device may not cause harmful interference, and
- (2) this device must accept any interference received, including interference that may cause undesired operation.

CALIFORNIA, USA ONLY

The Lithium battery adopted on this motherboard contains Perchlorate, a toxic substance controlled in Perchlorate Best Management Practices (BMP) regulations passed by the California Legislature. When you discard the Lithium battery in California, USA, please follow the related regulations in advance.

"Perchlorate Material-special handling may apply, see www.dtsc.ca.gov/hazardouswaste/perchlorate"

ASRock Website: <http://www.asrock.com>

Contents

1. Introduction	5
1.1 Package Contents	5
1.2 Specifications	6
1.3 Minimum Hardware Requirement Table for Windows® Vista™ Premium and Basic Logo	9
1.4 Motherboard Layout	10
1.5 HD8CH I/O	11
2. Installation	12
Pre-installation Precautions	12
2.1 CPU Installation	13
2.2 Installation of CPU Fan and Heatsink	13
2.3 Installation of Memory Modules (DIMM)	14
2.4 Expansion Slots (PCI and PCI Express slots)	16
2.5 Jumpers Setup	17
2.6 Onboard Headers and Connectors	18
2.7 HDMI_SPDIF Header Connection Guide	24
2.8 eSATAII Interface Introduction	25
2.9 SATAII Hard Disk Setup Guide	28
2.10 Serial ATA (SATA) / Serial ATAII (SATAII) Hard Disks Installation	29
2.11 Hot Plug and Hot Swap Functions for SATA / SATAII HDDs	30
2.12 Driver Installation Guide	30
2.13 Installing Windows® 2000 / XP / XP 64-bit / Vista™ / Vista™ 64-bit Without RAID Functions	31
2.13.1 Installing Windows® 2000 / XP / XP 64-bit Without RAID Functions	31
2.13.2 Installing Windows® Vista™ / Vista™ 64-bit Without RAID Functions	32
2.14 Installing Windows® 2000 / XP / XP 64-bit / Vista™ / Vista™ 64-bit With RAID Functions	33
2.14.1 Installing Windows® 2000 / XP / XP 64-bit With RAID Functions	33
2.14.2 Installing Windows® Vista™ / Vista™ 64-bit With RAID Functions	34
2.15 Untied Overclocking Technology	35
3. BIOS SETUP UTILITY	36
3.1 Introduction	36
3.1.1 BIOS Menu Bar	36
3.1.2 Navigation Keys	37

3.2	Main Screen	37
3.3	Advanced Screen	38
3.3.1	CPU Configuration	38
3.3.2	Chipset Configuration	42
3.3.3	ACPI Configuration	43
3.3.4	IDE Configuration	44
3.3.5	PCIPnP Configuration	46
3.3.6	Floppy Configuration	47
3.3.7	Super IO Configuration	47
3.3.8	USB Configuration	48
3.4	Hardware Health Event Monitoring Screen	49
3.5	Boot Screen	50
3.5.1	Boot Settings Configuration	50
3.6	Security Screen	51
3.7	Exit Screen	52
4.	Software Support	53
4.1	Install Operating System	53
4.2	Support CD Information	53
4.2.1	Running Support CD	53
4.2.2	Drivers Menu	53
4.2.3	Utilities Menu	53
4.2.4	Contact Information	53
	APPENDIX: AMD's Cool 'n' Quiet™ Technology	54

1. Introduction

Thank you for purchasing ASRock **ALiveNF5-eSATA2+** motherboard, a reliable motherboard produced under ASRock's consistently stringent quality control. It delivers excellent performance with robust design conforming to ASRock's commitment to quality and endurance.

In this manual, chapter 1 and 2 contain introduction of the motherboard and step-by-step guide to the hardware installation. Chapter 3 and 4 contain the configuration guide to BIOS setup and information of the Support CD.



Because the motherboard specifications and the BIOS software might be updated, the content of this manual will be subject to change without notice. In case any modifications of this manual occur, the updated version will be available on ASRock website without further notice. You may find the latest VGA cards and CPU support lists on ASRock website as well. ASRock website <http://www.asrock.com>

1.1 Package Contents

- 1 x ASRock **ALiveNF5-eSATA2+** Motherboard
(ATX Form Factor: 12.0-in x 8.0-in, 30.5 cm x 20.3 cm)
- 1 x ASRock **ALiveNF5-eSATA2+** Quick Installation Guide
- 1 x ASRock **ALiveNF5-eSATA2+** Support CD
- 1 x Ultra ATA 66/100/133 IDE Ribbon Cable (80-conductor)
- 1 x 3.5-in Floppy Drive Ribbon Cable
- 4 x Serial ATA (SATA) Data Cable (Optional)
- 2 x Serial ATA (SATA) HDD Power Cable (Optional)
- 1 x HDMI_SPDIF Cable (Optional)
- 1 x ASRock 8CH_eSATAII I/O Shield
- 1 x USB+1394 Bracket

1.2 Specifications

Platform	- ATX Form Factor: 12.0-in x 8.0-in, 30.5 cm x 20.3 cm
CPU	<ul style="list-style-type: none"> - Socket AM2 for AMD Athlon™ 64FX / 64X2 / 64 and Sempron processors - AMD LIVE!™ Ready - Supports AMD's Cool 'n' Quiet™ Technology (see CAUTION 1) - FSB 1000 MHz (2.0 GT/s) - Supports Untied Overclocking Technology (see CAUTION 2) - Supports Hyper-Transport Technology
Chipset	- NVIDIA® nForce 520
Memory	<ul style="list-style-type: none"> - Dual Channel DDRII Memory Technology (see CAUTION 3) - 4 x DDRII DIMM slots - Support DDRII800/667/533 - Max. capacity: 8GB (see CAUTION 4)
Hybrid Booster	<ul style="list-style-type: none"> - CPU Frequency Stepless Control (see CAUTION 5) - ASRock U-COP (see CAUTION 6) - Boot Failure Guard (B.F.G.) - ASRock AM2 Boost: ASRock Patented Technology to boost memory performance up to 12.5% (see CAUTION 7)
Expansion Slot	<ul style="list-style-type: none"> - 3 x PCI slots - 1 x PCI Express x16 slot - 2 x PCI Express x1 slots
Audio	- 7.1 CH Windows® Vista™ Premium Level HD Audio (ALC888 Audio Codec)
LAN	<ul style="list-style-type: none"> - PCIe x1 Gigabit LAN 10/100/1000 Mb/s - Realtek RTL8111B - Supports Wake-On-LAN
Rear Panel I/O	<p>ASRock 8CH_eSATAII I/O</p> <ul style="list-style-type: none"> - 1 x PS/2 Mouse Port - 1 x PS/2 Keyboard Port - 1 x Serial Port: COM1 - 1 x Parallel Port (ECP/EPP Support) - 2 x Ready-to-Use USB 2.0 Ports - 2 x eSATAII Ports - 1 x RJ-45 Port - HD Audio Jack: Side Speaker/Rear Speaker/Central/Bass/Line in/Front Speaker/Microphone (see CAUTION 8) <p>Free Bundle: USB+1394 bracket, providing 2 additional USB 2.0 ports and 1 IEEE 1394 port</p>

Connector	<ul style="list-style-type: none"> - 4 x SATAII 3.0Gb/s connectors, support RAID (RAID 0, RAID 1, RAID 0+1, JBOD, RAID 5), NCQ, AHCI and “Hot Plug” functions (see CAUTION 9) - 2 x eSATAII 3.0Gb/s connectors (shared with 2 SATAII connectors), support NCQ, AHCI and “Hot Plug” function (see CAUTION 10) - 1 x ATA133 IDE connector (supports 2 x IDE devices) - 1 x Floppy connector - 1 x IR header - 1 x Game header - 1 x HDMI_SPDIF header - 2 x IEEE 1394 headers - CPU/Chassis FAN connector - 20 pin ATX power connector - 4 pin 12V power connector - CD in header - Front panel audio connector - 4 x USB 2.0 headers (support 8 USB 2.0 ports) (see CAUTION 11)
BIOS Feature	<ul style="list-style-type: none"> - 4Mb AMI BIOS - AMI Legal BIOS - Supports “Plug and Play” - ACPI 1.1 Compliance Wake Up Events - Supports jumperfree - SMBIOS 2.3.1 Support
Support CD	- Drivers, Utilities, AntiVirus Software (Trial Version)
Hardware Monitor	<ul style="list-style-type: none"> - CPU Internal Temperature Sensing - CPU Ambient Temperature Sensing - Chassis Temperature Sensing - CPU Fan Tachometer - Chassis Fan Tachometer - CPU Quiet Fan - Voltage Monitoring: +12V, +5V, +3.3V, Vcore
OS	- Microsoft® Windows® 2000 / XP / XP Media Center / XP 64-bit / Vista™ / Vista™ 64-bit compliant (see CAUTION 12)
Certifications	- FCC, CE, WHQL Certificated

WARNING

Please realize that there is a certain risk involved with overclocking, including adjusting the setting in the BIOS, applying Untied Overclocking Technology, or using the third-party overclocking tools. Overclocking may affect your system stability, or even cause damage to the components and devices of your system. It should be done at your own risk and expense. We are not responsible for possible damage caused by overclocking.

CAUTION!

1. For power-saving's sake, it is strongly recommended to enable AMD's Cool 'n' Quiet™ technology under Windows system. See APPENDIX on page 54 to enable AMD's Cool 'n' Quiet™ technology.
2. This motherboard supports Untied Overclocking Technology. Please read "Untied Overclocking Technology" on page 35 for details.
3. This motherboard supports Dual Channel Memory Technology. Before you implement Dual Channel Memory Technology, make sure to read the installation guide of memory modules on page 14 for proper installation.
4. Due to the operating system limitation, the actual memory size may be less than 4GB for the reservation for system usage under Windows® XP and Windows® Vista™. For Windows® XP 64-bit and Windows® Vista™ 64-bit with 64-bit CPU, there is no such limitation.
5. Although this motherboard offers stepless control, it is not recommended to perform over-clocking. Frequencies other than the recommended CPU bus frequencies may cause the instability of the system or damage the CPU.
6. While CPU overheat is detected, the system will automatically shutdown. Before you resume the system, please check if the CPU fan on the motherboard functions properly and unplug the power cord, then plug it back again. To improve heat dissipation, remember to spray thermal grease between the CPU and the heatsink when you install the PC system.
7. This motherboard supports ASRock AM2 Boost overclocking technology. If you enable this function in the BIOS setup, the memory performance will improve up to 12.5%, but the effect still depends on the AM2 CPU you adopt. Enabling this function will overclock the chipset/CPU reference clock. However, we can not guarantee the system stability for all CPU/DRAM configurations. If your system is unstable after AM2 Boost function is enabled, it may not be applicative to your system. You may choose to disable this function for keeping the stability of your system.
8. For microphone input, this motherboard supports both stereo and mono modes. For audio output, this motherboard supports 2-channel, 4-channel, 6-channel, and 8-channel modes. Please check the table on page 11 for proper connection.
9. Before installing SATAII hard disk to SATAII connector, please read the "SATAII Hard Disk Setup Guide" on page 28 to adjust your SATAII hard disk drive to SATAII mode. You can also connect SATA hard disk to SATAII connector directly.
10. This motherboard supports eSATAII interface, the external SATAII specification. Please read "eSATAII Interface Introduction" on page 25 for details about eSATAII and eSATAII installation procedures.
11. Power Management for USB 2.0 works fine under Microsoft® Windows® Vista™ 64-bit / Vista™ / XP 64-bit / XP SP1 or SP2 / 2000 SP4.
12. Microsoft® Windows® Vista™ / Vista™ 64-bit driver keeps on updating now. As long as we have the latest driver, we will update it to our website in the future. Please visit our website for Microsoft® Windows® Vista™ / Vista™ 64-bit driver and related information.
ASRock website <http://www.asrock.com>

1.3 Minimum Hardware Requirement Table for Windows® Vista™ Premium and Basic Logo

For system integrators and users who purchase this motherboard and plan to submit Windows® Vista™ Premium and Basic logo, please follow the below table for minimum hardware requirement.

CPU	Sempron 2800+
Memory	512MB Single Channel
VGA	DX9.0 with WDDM Driver
	with 128bit VGA memory (Premium)
	with 64bit VGA memory (Basic)

1.4 Motherboard Layout

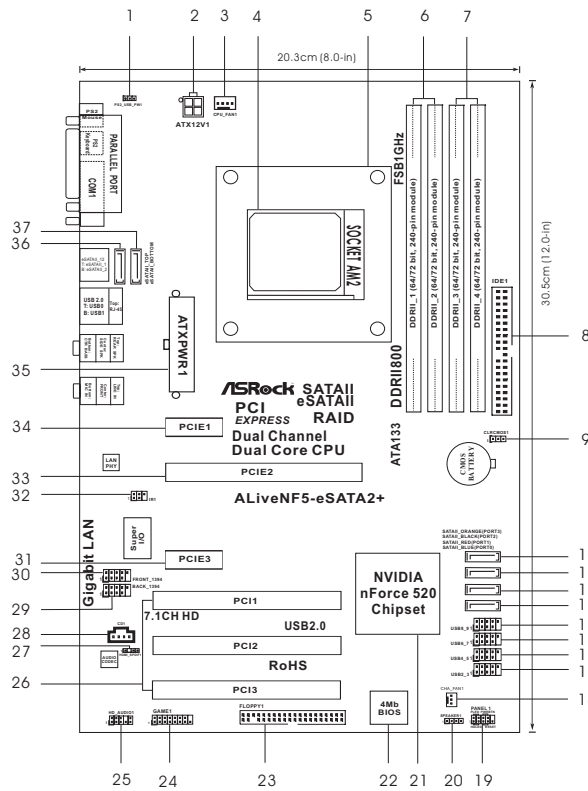

- | | | | |
|----|---|----|---|
| 1 | PS2_USB_PW1 Jumper | 19 | System Panel Header (PANEL1) |
| 2 | ATX 12V Power Connector (ATX12V1) | 20 | Chassis Speaker Header (SPEAKER 1) |
| 3 | CPU Fan Connector (CPU_FAN1) | 21 | NVIDIA nForce 520 Single Chip |
| 4 | AM2 940-Pin CPU Socket | 22 | Flash Memory |
| 5 | CPU Heatsink Retention Module | 23 | Floppy Connector (FLOPPY1) |
| 6 | 2 x 240-pin DDR2 DIMM Slots
(Dual Channel A: DDR2_1, DDR2_2; Yellow) | 24 | Game Port Header (GAME1) |
| 7 | 2 x 240-pin DDR2 DIMM Slots
(Dual Channel B: DDR2_3, DDR2_4; Orange) | 25 | Front Panel Audio Header (HD_AUDIO1) |
| 8 | Primary IDE Connector (IDE1, Blue) | 26 | PCI Slots (PCI1- 3) |
| 9 | Clear CMOS Jumper (CLRCMOS1) | 27 | HDMI_SPDIF Header (HDMI_SPDIF1) |
| 10 | SATAII Connector (SATAII_ORANGE (PORT3)) | 28 | Internal Audio Connector: CD1 (Black) |
| 11 | SATAII Connector (SATAII_BLACK (PORT2)) | 29 | Back Panel IEEE 1394 Header (BACK_1394) |
| 12 | SATAII Connector (SATAII_RED (PORT1)) | 30 | Front Panel IEEE 1394 Header (FRONT_1394) |
| 13 | SATAII Connector (SATAII_BLUE (PORT0)) | 31 | PCI Express x1 Slot (PCIE3) |
| 14 | USB 2.0 Header (USB8_9, Blue) | 32 | Infrared Module Header (IR1) |
| 15 | USB 2.0 Header (USB6_7, Blue) | 33 | PCI Express x16 Slot (PCIE2) |
| 16 | USB 2.0 Header (USB4_5, Blue) | 34 | PCI Express x1 Slot (PCIE1) |
| 17 | USB 2.0 Header (USB2_3, Blue) | 35 | ATX Power Connector (ATXPWR1) |
| 18 | Chassis Fan Connector (CHA_FAN1) | 36 | eSATAII Connector (eSATAII_TOP) |
| | | 37 | eSATAII Connector (eSATAII_BOTTOM) |

1.5 ASRock 8CH_eSATAII I/O

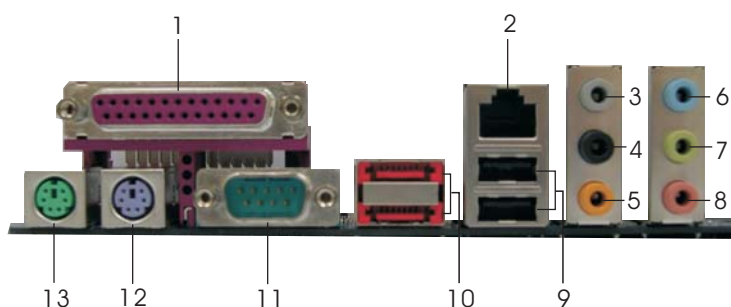

- | | | | |
|----|-------------------------|----|-----------------------------|
| 1 | Parallel Port | 8 | Microphone (Pink) |
| 2 | RJ-45 Port | 9 | USB 2.0 Ports (USB01) |
| 3 | Side Speaker (Gray) | 10 | eSATAII Ports |
| 4 | Rear Speaker (Black) | 11 | COM Port |
| 5 | Central / Bass (Orange) | 12 | PS/2 Keyboard Port (Purple) |
| 6 | Line In (Light Blue) | 13 | PS/2 Mouse Port (Green) |
| *7 | Front Speaker (Lime) | | |

* If you use 2-channel speaker, please connect the speaker's plug into "Front Speaker Jack". See the table below for connection details in accordance with the type of speaker you use.

TABLE for Audio Output Connection

Audio Output Channels	Front Speaker (No. 7)	Rear Speaker (No. 4)	Central / Bass (No. 5)	Side Speaker (No. 3)
2	V	--	--	--
4	V	V	--	--
6	V	V	V	--
8	V	V	V	V

* To enable Multi-Streaming function, you need to connect a front panel audio cable to the front panel audio header. After restarting your computer, you will find "Mixer" tool on your system. Please select "Mixer ToolBox" , click "Enable playback multi-streaming", and click

"ok". Choose "2CH", "4CH", "6CH", or "8CH" and then you are allowed to select "Realtek HDA Primary output" to use Rear Speaker, Central/Bass, and Front Speaker, or select "Realtek HDA Audio 2nd output" to use front panel audio.



Free Bundle

ASRock provides you with one **USB+1394 bracket**, which can support 2 additional USB 2.0 ports and 1 IEEE 1394 port.

2. Installation

This is an ATX form factor (12.0-in x 8.0-in, 30.5 cm x 20.3 cm) motherboard. Before you install the motherboard, study the configuration of your chassis to ensure that the motherboard fits into it.

Pre-installation Precautions

Take note of the following precautions before you install motherboard components or change any motherboard settings.



Before you install or remove any component, ensure that the power is switched off or the power cord is detached from the power supply. Failure to do so may cause severe damage to the motherboard, peripherals, and/or components.

1. Unplug the power cord from the wall socket before touching any component.
2. To avoid damaging the motherboard components due to static electricity, NEVER place your motherboard directly on the carpet or the like. Also remember to use a grounded wrist strap or touch a safety grounded object before you handle components.
3. Hold components by the edges and do not touch the ICs.
4. Whenever you uninstall any component, place it on a grounded anti-static pad or in the bag that comes with the component.
5. When placing screws into the screw holes to secure the motherboard to the chassis, please do not over-tighten the screws! Doing so may damage the motherboard.

2.1 CPU Installation

- Step 1. Unlock the socket by lifting the lever up to a 90° angle.
- Step 2. Position the CPU directly above the socket such that the CPU corner with the golden triangle matches the socket corner with a small triangle.
- Step 3. Carefully insert the CPU into the socket until it fits in place.



The CPU fits only in one correct orientation. DO NOT force the CPU into the socket to avoid bending of the pins.

- Step 4. When the CPU is in place, press it firmly on the socket while you push down the socket lever to secure the CPU. The lever clicks on the side tab to indicate that it is locked.



STEP 1:
Lift Up The Socket Lever

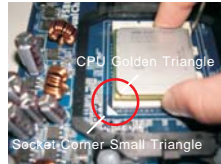

STEP 2 / STEP 3:
Match The CPU Golden Triangle
To The Socket Corner Small
Triangle



STEP 4:
Push Down And Lock
The Socket Lever

2.2 Installation of CPU Fan and Heatsink

After you install the CPU into this motherboard, it is necessary to install a larger heatsink and cooling fan to dissipate heat. You also need to spray thermal grease between the CPU and the heatsink to improve heat dissipation. Make sure that the CPU and the heatsink are securely fastened and in good contact with each other. Then connect the CPU fan to the CPU FAN connector (CPU_FAN1, see Page 10, No. 3). For proper installation, please kindly refer to the instruction manuals of the CPU fan and the heatsink.

2.3 Installation of Memory Modules (DIMM)

This motherboard provides four 240-pin DDRII (Double Data Rate II) DIMM slots, and supports Dual Channel Memory Technology. For dual channel configuration, you always need to install **identical** (the same brand, speed, size and chip-type) DDRII DIMM pair in the slots of the same color. In other words, you have to install **identical** DDRII DIMM pair in **Dual Channel A** (DDRII_1 and DDRII_2; Yellow slots; see p.10 No.6) or **identical** DDRII DIMM pair in **Dual Channel B** (DDRII_3 and DDRII_4; Orange slots; see p.10 No.7), so that Dual Channel Memory Technology can be activated. This motherboard also allows you to install four DDRII DIMMs for dual channel configuration, and please install **identical** DDRII DIMMs in all four slots. You may refer to the Dual Channel Memory Configuration Table below.

Dual Channel Memory Configurations

	DDRII_1 (Yellow Slot)	DDRII_2 (Yellow Slot)	DDRII_3 (Orange Slot)	DDRII_4 (Orange Slot)
(1)	Populated	Populated	-	-
(2)	-	-	Populated	Populated
(3)*	Populated	Populated	Populated	Populated

* For the configuration (3), please install **identical** DDRII DIMMs in all four slots.



1. If you want to install two memory modules, for optimal compatibility and reliability, it is recommended to install them in the slots of the same color. In other words, install them either in the set of yellow slots (DDRII_1 and DDRII_2), or in the set of orange slots (DDRII_3 and DDRII_4).
2. If only one memory module or three memory modules are installed in the DDRII DIMM slots on this motherboard, it is unable to activate the Dual Channel Memory Technology.
3. If a pair of memory modules is NOT installed in the same Dual Channel, for example, installing a pair of memory modules in DDRII_1 and DDRII_3, it is unable to activate the Dual Channel Memory Technology .
4. It is not allowed to install a DDR memory module into DDRII slot; otherwise, this motherboard and DIMM may be damaged.

Installing a DIMM



Please make sure to disconnect power supply before adding or removing DIMMs or the system components.

- Step 1. Unlock a DIMM slot by pressing the retaining clips outward.
Step 2. Align a DIMM on the slot such that the notch on the DIMM matches the break on the slot.

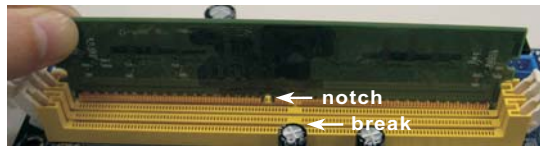
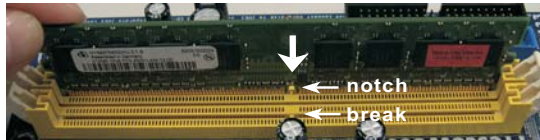

The DIMM only fits in one correct orientation. It will cause permanent damage to the motherboard and the DIMM if you force the DIMM into the slot at incorrect orientation.

- Step 3. Firmly insert the DIMM into the slot until the retaining clips at both ends fully snap back in place and the DIMM is properly seated.

2.4 Expansion Slots (PCI and PCI Express Slots)

There are 3 PCI slots and 3 PCI Express slots on this motherboard.

PCI Slots: PCI slots are used to install expansion cards that have the 32-bit PCI interface.

PCI Express Slots: PCI Express (PCIe) x1 slot is used for PCI Express cards with x1 lane width cards, such as Gigabit LAN card, SATA2 card, etc.

PCI Express (PCIe) x16 slot is used for PCI Express cards with x16 lane width graphics cards.

Installing an expansion card

- Step 1. Before installing the expansion card, please make sure that the power supply is switched off or the power cord is unplugged. Please read the documentation of the expansion card and make necessary hardware settings for the card before you start the installation.
- Step 2. Remove the system unit cover (if your motherboard is already installed in a chassis).
- Step 3. Remove the bracket facing the slot that you intend to use. Keep the screws for later use.
- Step 4. Align the card connector with the slot and press firmly until the card is completely seated on the slot.
- Step 5. Fasten the card to the chassis with screws.
- Step 6. Replace the system cover.

2.5 Jumpers Setup

The illustration shows how jumpers are setup. When the jumper cap is placed on pins, the jumper is "Short". If no jumper cap is placed on pins, the jumper is "Open". The illustration shows a 3-pin jumper whose pin1 and pin2 are "Short" when jumper cap is placed on these 2 pins.



Jumper	Setting	
PS2_USB_PW1 (see p.10, No. 1)	<div style="display: inline-block; text-align: center;"> <p>1_2</p> <p>+5V</p> </div> <div style="display: inline-block; text-align: center; margin-left: 20px;"> <p>2_3</p> <p>+5VSB</p> </div>	Short pin2, pin3 to enable +5VSB (standby) for PS/2 or USB wake up events.

Note: To select +5VSB, it requires 2 Amp and higher standby current provided by power supply.

Clear CMOS Jumper (CLR CMOS1) (see p.10, No. 9)	<div style="display: inline-block; text-align: center;"> <p>1_2</p> <p>Default</p> </div> <div style="display: inline-block; text-align: center; margin-left: 20px;"> <p>2_3</p> <p>Clear CMOS</p> </div>
---	---

Note: CLR CMOS1 allows you to clear the data in CMOS. The data in CMOS includes system setup information such as system password, date, time, and system setup parameters. To clear and reset the system parameters to default setup, please turn off the computer and unplug the power cord from the power supply. After waiting for 15 seconds, use a jumper cap to short pin2 and pin3 on CLR CMOS1 for 5 seconds. However, please do not clear the CMOS right after you update the BIOS. If you need to clear the CMOS when you just finish updating the BIOS, you must boot up the system first, and then shut it down before you do the clear-CMOS action.

2.6 Onboard Headers and Connectors



Onboard headers and connectors are NOT jumpers. Do NOT place jumper caps over these headers and connectors. Placing jumper caps over the headers and connectors will cause permanent damage of the motherboard!

Floppy Connector

(33-pin FLOPPY1)

(see p.10, No. 23)



Note: Make sure the red-striped side of the cable is plugged into Pin1 side of the connector.

Primary IDE connector (Blue)

(39-pin IDE1, see p.10, No. 8)



connect the blue end
to the motherboard



connect the black end
to the IDE devices

80-conductor ATA 66/100/133 cable

Note: Please refer to the instruction of your IDE device vendor for the details.

Serial ATA II Connectors

(SATAII_ORANGE (PORT3):

see p.10, No. 10)



SATAII_ORANGE (PORT3)

(SATAII_BLACK (PORT2):

see p.10, No. 11)



SATAII_BLACK (PORT2)

(SATAII_RED (PORT1):

see p.10, No. 12)



SATAII_RED (PORT1)

(SATAII_BLUE (PORT0):

see p.10, No. 13)



SATAII_BLUE (PORT0)

These four Serial ATAII

(SATAII) connectors support SATA data cables for internal storage devices. The current SATAII interface allows up to 3.0 Gb/s data transfer rate.



SATAII_RED (PORT1) and SATAII_ORANGE (PORT3) connectors can be used for internal storage devices or be connected to eSATAII_BOTTOM and eSATAII_TOP connectors with corresponding color to support eSATAII devices. Please read "eSATAII Interface Introduction" on page 25 for details about eSATAII and eSATAII installation procedures.

eSATA II Connectors

(eSATAII_TOP: see p.10, No. 36)

(eSATAII_BOTTOM: see p.10, No. 37)



These two eSATAII connectors support SATA data cables for external SATAII function. The current eSATA II interface allows up to 3.0 Gb/s data transfer rate.

Serial ATA (SATA) Data Cable

(Optional)



Either end of the SATA data cable can be connected to the SATA / SATAII hard disk or the SATAII connector on the motherboard. You can also use the SATA data cable to connect SATAII connectors and eSATAII connectors with corresponding color.

Serial ATA (SATA) Power Cable

(Optional)

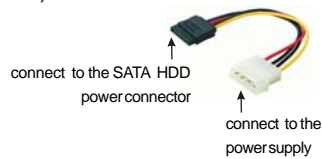

Please connect the black end of SATA power cable to the power connector on each drive. Then connect the white end of SATA power cable to the power connector of the power supply.

USB 2.0 Headers

(9-pin USB8_9)

(see p.10 No. 14)

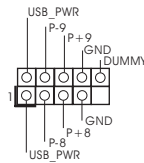

Besides two default USB 2.0 ports on the I/O panel, there are four USB 2.0 headers on this motherboard. Each USB 2.0 header can support two USB 2.0 ports.

(9-pin USB6_7)

(see p.10 No. 15)

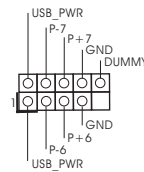

(9-pin USB4_5)

(see p.10 No. 16)

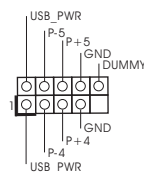

(9-pin USB2_3)
(see p.10 No. 17)

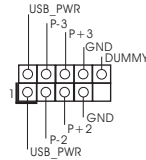

Infrared Module Header

(5-pin IR1)
(see p.10, No. 32)

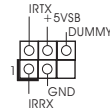

This header supports an optional wireless transmitting and receiving infrared module.

Internal Audio Connectors

(4-pin CD1)
(CD1: see p.10, No. 28)

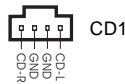

This connector allows you to receive stereo audio input from sound sources such as a CD-ROM, DVD-ROM, TV tuner card, or MPEG card.

Front Panel Audio Header

(9-pin HD_AUDIO1)
(see p.10, No. 25)

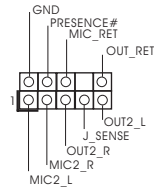

This is an interface for the front panel audio cable that allows convenient connection and control of audio devices.



1. High Definition Audio supports Jack Sensing, but the panel wire on the chassis must support HDA to function correctly. Please follow the instruction in our manual and chassis manual to install your system.
2. If you use AC'97 audio panel, please install it to the front panel audio header as below:
 - A. Connect Mic_IN (MIC) to MIC2_L.
 - B. Connect Audio_R (RIN) to OUT2_R and Audio_L (LIN) to OUT2_L.
 - C. Connect Ground (GND) to Ground (GND).
 - D. MIC_RET and OUT_RET are for HD audio panel only. You don't need to connect them for AC'97 audio panel.
 - E. Enter BIOS Setup Utility. Enter Advanced Settings, and then select Chipset Configuration. Set the Front Panel Control option from [Auto] to [Enabled].
 - F. Enter Windows system. Click the icon on the lower right hand taskbar to enter Realtek HD Audio Manager. Click "Audio I/O", select "Connector Settings" , choose "Disable front panel jack detection", and save the change by clicking "OK".

System Panel Header

(9-pin PANEL1)
(see p.10, No. 19)

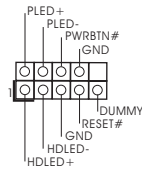

This header accommodates several system front panel functions.

Chassis Speaker Header

(4-pin SPEAKER 1)
(see p.10, No. 20)

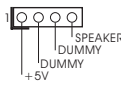

Please connect the chassis speaker to this header.

Chassis Fan Connector

(3-pin CHA_FAN1)
(see p.10, No. 18)

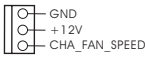

Please connect a chassis fan cable to this connector and match the black wire to the ground pin.

CPU Fan Connector

(4-pin CPU_FAN1)
(see p.10, No. 3)

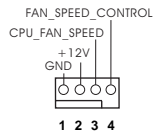

Please connect the CPU fan cable to this connector and match the black wire to the ground pin.



Though this motherboard provides 4-Pin CPU fan (Quiet Fan) support, the 3-Pin CPU fan still can work successfully even without the fan speed control function. If you plan to connect the 3-Pin CPU fan to the CPU fan connector on this motherboard, please connect it to Pin 1-3.

Pin 1-3 Connected

3-Pin Fan Installation



ATX Power Connector

(20-pin ATXPWR1)
(see p.10, No. 35)



Please connect an ATX power supply to this connector.

ATX 12V Power Connector

(4-pin ATX12V1)
(see p.10, No. 2)



Please note that it is necessary to connect a power supply with ATX 12V plug to this connector. Failing to do so will cause power up failure.

Game Port Header
 (15-pin GAME1)
 (see p.10, No. 24)

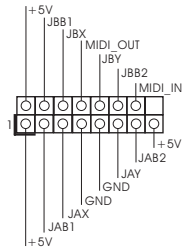

Connect a Game cable to this header if the Game port bracket is installed.

IEEE 1394 Headers
 (9-pin FRONT_1394)
 (see p.10, No. 30)

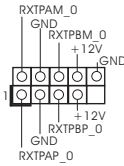

(9-pin BACK_1394)
 (see p.10, No. 29)

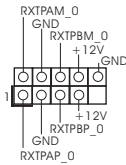

There are two IEEE 1394 headers on this motherboard, including one front panel IEEE 1394 header (FRONT_1394) and one back panel IEEE 1394 header (BACK_1394). Each IEEE 1394 header can support one IEEE 1394 port.

HDMI_SPDIF Header
 (3-pin HDMI_SPDIF1)
 (see p.10, No. 27)



HDMI_SPDIF header, providing SPDIF audio output to HDMI VGA card, allows the system to connect HDMI Digital TV/projector/LCD devices. Please connect the HDMI_SPDIF connector of HDMI VGA card to this header.

HDMI_SPDIF Cable
(Optional)

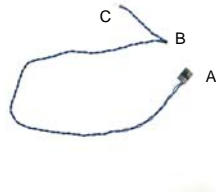

Please connect the black end (A) of HDMI_SPDIF cable to the HDMI_SPDIF header on the motherboard. Then connect the white end (B or C) of HDMI_SPDIF cable to the HDMI_SPDIF connector of HDMI VGA card.

A. black end



B. white end (2-pin)

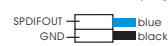

C. white end (3-pin)

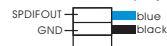

USB+1394 Bracket



This USB+1394 bracket can support 2 additional USB 2.0 ports and 1 IEEE 1394 port. Please connect the blue connector on the cable of this USB+1394 bracket to the USB 2.0 header (USB2_3, USB4_5, USB6_7 or USB8_9), and connect the red connector on the cable of this USB+1394 bracket to the IEEE 1394 header (BACK_1394). Then fasten the USB+1394 bracket to the chassis with screws.

2.7 HDMI_SPDIF Header Connection Guide

HDMI (High-Definition Multi-media Interface) is an all-digital audio/video specification, which provides an interface between any compatible digital audio/video source, such as a set-top box, DVD player, A/V receiver and a compatible digital audio or video monitor, such as a digital television (DTV). A complete HDMI system requires a HDMI VGA card and a HDMI ready motherboard with a HDMI_SPDIF header. This motherboard is equipped with a HDMI_SPDIF header, which provides SPDIF audio output to HDMI VGA card, allows the system to connect HDMI Digital TV/projector/LCD devices. To use HDMI function on this motherboard, please carefully follow the below steps.

Step 1. Install the HDMI VGA card to the PCI Express Graphics slot on this motherboard. For the proper installation of HDMI VGA card, please refer to the installation guide on page 16.

Step 2. Connect the black end (A) of HDMI_SPDIF cable to the HDMI_SPDIF header (HDMI_SPDIF1, yellow, see page 10, No. 27) on the motherboard.



Make sure to correctly connect the HDMI_SPDIF cable to the motherboard and the HDMI VGA card according to the same pin definition. For the pin definition of HDMI_SPDIF header and HDMI_SPDIF cable connectors, please refer to page 22. For the pin definition of HDMI_SPDIF connectors on HDMI VGA card, please refer to the user manual of HDMI VGA card vendor. Incorrect connection may cause permanent damage to this motherboard and the HDMI VGA card.

Step 3. Connect the white end (B or C) of HDMI_SPDIF cable to the HDMI_SPDIF connector of HDMI VGA card. (There are two white ends (2-pin and 3-pin) on HDMI_SPDIF cable. Please choose the appropriate white end according to the HDMI_SPDIF connector of the HDMI VGA card you install.



white end
(2-pin) (B)



white end
(3-pin) (C)



Please do not connect the white end of HDMI_SPDIF cable to the wrong connector of HDMI VGA card or other VGA card. Otherwise, the motherboard and the VGA card may be damaged. For example, this picture shows the wrong example of connecting HDMI_SPDIF cable to the fan connector of PCI Express VGA card. Please refer to the VGA card user manual for connector usage in advance.



Step 4. Connect the HDMI output connector on HDMI VGA card to HDMI device, such as HDTV. Please refer to the user manual of HDTV and HDMI VGA card vendor for detailed connection procedures.



Step 5. Install HDMI VGA card driver to your system.

2.8 eSATAII Interface Introduction

What is eSATAII?

This motherboard supports eSATAII interface, the external SATAII specification. eSATAII allows you to enjoy the SATAII function provided by the I/O of your computer, offering the high speed data transfer rate up to 3.0Gb/s, and the convenient mobility like USB. eSATAII is equipped with Hot Plug capability that enables you to exchange drives easily. For example, with eSATAII interface, you may simply plug your eSATAII hard disk to the eSATAII ports instead of opening your chassis to exchange your SATAII hard disk. Currently, on the market, the data transfer rate of USB 2.0 is up to 480Mb/s, and for IEEE 1394 is up to 400Mb/s. However, eSATAII provides the data transfer rate up to 3000Mb/s, which is much higher than USB 2.0 and IEEE 1394, and still keeps the convenience of Hot Plug feature. Therefore, on the basis of the advantageous transfer speed and the facilitating mobile capability, in the near future, eSATAII will replace USB 2.0 and IEEE 1394 to be a trend for external interface.

NOTE:

1. If you set "SATA Operation Mode" option in BIOS setup to AHCI or RAID mode, Hot Plug function is supported with eSATAII devices. Therefore, you can insert or remove your eSATAII devices to the eSATAII ports while the system is power-on and in working condition.
2. If you set "SATA Operation Mode" option in BIOS setup to non-RAID mode, Hot Plug function is not supported with eSATAII devices. If you still want to use eSATAII function in non-RAID mode, please insert or remove your eSATAII devices to the eSATAII ports only when the system is power-off.
3. Please refer to page 31 to 35 for detailed information of RAID mode, non-RAID mode, and AHCI mode.

How to install eSATAII?

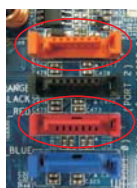

SATAII_RED (PORT1) and
SATAII_ORANGE (PORT3)



eSATAII_TOP and
eSATAII_BOTTOM

1. If you just plan to install one eSATAII device to this motherboard, it is recommended to enable the bottom eSATAII port of the I/O shield. In order to enable the bottom eSATAII port of the I/O shield, you need to connect the red SATAII connector (SATAII_RED (PORT1); see p.10 No.12) and the red eSATAII connector (eSATAII_BOTTOM; see p.10 No.37) with a SATA data cable first. Then the bottom eSATAII port of the I/O shield is enabled.



Connect the SATA data cable to the red SATAII connector (SATAII_RED (PORT1))



Connect the SATA data cable to the red eSATAII connector (eSATAII_BOTTOM)



2. If you plan to install two eSATAII devices to this motherboard, you need to enable both the top and the bottom eSATAII ports of the I/O shield. In order to enable the top and the bottom eSATAII ports of the I/O shield, you have to connect the red SATAII connector (SATAII_RED (PORT1); see p.10 No.12) and the red eSATAII connector (eSATAII_BOTTOM; see p.10 No.37) with a SATA data cable first, and then connect the orange SATAII connector (SATAII_ORANGE (PORT3); see p.10 No.10) and the orange eSATAII connector (eSATAII_TOP; see p.10 No.36) with another SATA data cable. After that, both the top and the bottom eSATAII ports of the I/O shield are enabled.



Connect the SATA data cables to both red SATAII connector (SATAII_RED (PORT1)) and orange SATAII connector (SATAII_ORANGE (PORT3))



Connect the SATA data cables to both red eSATAII connector (eSATAII_BOTTOM) and orange eSATAII connector (eSATAII_TOP)



Please make sure to correctly connect the SATAII and eSATAII connectors with corresponding color so that the eSATAII function will work successfully.

3. Use the eSATAII device cable to connect eSATAII device and the eSATAII port of the I/O shield according to the eSATAII connector that you connect the SATA data cable.



Connect one end of the eSATAII device cable to eSATAII device



Connect the other end of the eSATAII device cable to eSATAII port of the I/O shield

Comparison between eSATAII and other devices

IEEE 1394	400Mb/s
USB 2.0	480Mb/s
SATA	1.5Gb/s (1500Mb/s)
eSATAII/SATAII	3.0Gb/s (3000Mb/s)

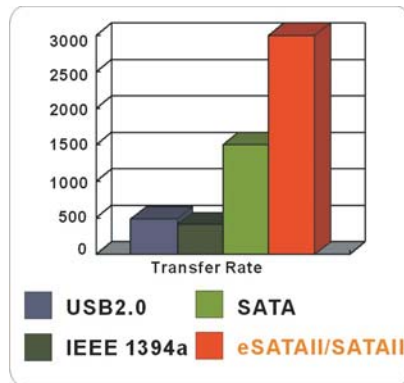

2.9 SATAII Hard Disk Setup Guide

Before installing SATAII hard disk to your computer, please carefully read below SATAII hard disk setup guide. Some default setting of SATAII hard disks may not be at SATAII mode, which operate with the best performance. In order to enable SATAII function, please follow the below instruction with different vendors to correctly adjust your SATAII hard disk to SATAII mode in advance; otherwise, your SATAII hard disk may fail to run at SATAII mode.

Western Digital



If pin 5 and pin 6 are shorted, SATA 1.5Gb/s will be enabled.
On the other hand, if you want to enable SATAII 3.0Gb/s, please remove the jumpers from pin 5 and pin 6.

SAMSUNG



If pin 3 and pin 4 are shorted, SATA 1.5Gb/s will be enabled.
On the other hand, if you want to enable SATAII 3.0Gb/s, please remove the jumpers from pin 3 and pin 4.

HITACHI

Please use the Feature Tool, a DOS-bootable tool, for changing various ATA features. Please visit HITACHI's website for details:

<http://www.hitachigst.com/hdd/support/download.htm>



The above examples are just for your reference. For different SATAII hard disk products of different vendors, the jumper pin setting methods may not be the same. Please visit the vendors' website for the updates.

2.10 Serial ATA (SATA) / Serial ATAII (SATAII) Hard Disks Installation

This motherboard adopts NVIDIA® nForce 520 chipset that supports Serial ATA (SATA) / Serial ATAII (SATAII) hard disks and RAID functions. You may install SATA / SATAII hard disks on this motherboard for internal storage devices. This section will guide you to install the SATA / SATAII hard disks.

STEP 1: Install the SATA / SATAII hard disks into the drive bays of your chassis.

STEP 2: Connect the SATA power cable to the SATA / SATAII hard disk.

STEP 3: Connect one end of the SATA data cable to the motherboard's SATAII connector.

STEP 4: Connect the other end of the SATA data cable to the SATA / SATAII hard disk.



1. If you plan to use RAID 0 or RAID 1 function, you need to install at least 2 SATA / SATAII hard disks. If you plan to use RAID 5 function, you need to install 3 SATA / SATAII hard disks. If you plan to use RAID 0+1 function, you need to install 4 SATA / SATAII hard disks.
2. It is recommended to build RAID on internal SATA / SATAII ports. In other words, if SATAII_RED (PORT1) and SATAII_ORANGE (PORT3) are used for eSATAII ports, please build RAID on SATAII_BLUE (PORT0) and SATAII_BLACK (PORT2).

2.11 Hot Plug and Hot Swap Functions for SATA / SATAII HDDs and eSATAII Devices

This motherboard supports Hot Plug and Hot Swap functions for SATA / SATAII / eSATAII Devices in RAID / AHCI mode. NVIDIA® nForce 520 chipset provides hardware support for Advanced Host controller Interface (AHCI), a new programming interface for SATA host controllers developed thru a joint industry effort. AHCI also provides usability enhancements such as Hot Plug.



NOTE

What is Hot Plug Function?

If the SATA / SATAII HDDs are NOT set for RAID configuration, it is called "Hot Plug" for the action to insert and remove the SATA / SATAII HDDs while the system is still power-on and in working condition.

However, please note that it cannot perform Hot Plug if the OS has been installed into the SATA / SATAII HDD.

What is Hot Swap Function?

If SATA / SATAII HDDs are built as RAID1 or RAID 5 then it is called "Hot Swap" for the action to insert and remove the SATA / SATAII HDDs while the system is still power-on and in working condition.

eSATAII is equipped with Hot Plug capability that enables you to exchange drives easily. For example, with eSATAII interface, you may simply plug your eSATAII devices to the eSATAII ports instead of opening your chassis to exchange your SATAII hard disk.

2.12 Driver Installation Guide

To install the drivers to your system, please insert the support CD to your optical drive first. Then, the drivers compatible to your system can be auto-detected and listed on the support CD driver page. Please follow the order from up to bottom side to install those required drivers. Therefore, the drivers you install can work properly.

2.13 Installing Windows® 2000 / XP / XP 64-bit / Vista™ / Vista™ 64-bit Without RAID Functions

If you want to install Windows® 2000, Windows® XP, Windows® XP 64-bit, Windows® Vista™ or Windows® Vista™ 64-bit on your SATA / SATAII HDDs without RAID functions, please follow below procedures according to the OS you install.



1. The installation procedures for Windows® Vista™ / Vista™ 64-bit are subject to change. Please visit our website for the updates of Windows® Vista™ / Vista™ 64-bit driver and related information in the future.
2. Before installing Windows® 2000 to your system, your Windows® 2000 optical disk is supposed to include SP4. If there is no SP4 included in your disk, please visit the below website for proper procedures of making a SP4 disk:
http://www.microsoft.com/Windows2000/downloads/servicepacks/sp4/spdeploy.htm#the_integrated_installation_fmay

2.13.1 Installing Windows® 2000 / XP / XP 64-bit Without RAID Functions

If you want to install Windows® 2000 / Windows® XP / Windows® XP 64-bit on your SATA / SATAII HDDs without RAID functions, please follow below steps.

Using SATA / SATAII HDDs and eSATAII devices with NCQ and Hot Plug functions

STEP 1: Set Up BIOS.

- A. Enter BIOS SETUP UTILITY → Advanced screen → IDE Configuration.
- B. Set the "SATA Operation Mode" option to [AHCI].

STEP 2: Make a SATA / SATAII driver diskette.

- A. Insert the ASRock Support CD into your optical drive to boot your system.
- B. During POST at the beginning of system boot-up, press <F11> key, and then a window for boot devices selection appears. Please select CD-ROM as the boot device.
- C. When you see the message on the screen, "Generate Serial ATA driver diskette [YN]?", press <Y>.
- D. Then you will see these messages,

Please choose:

1. Generate AHCI Driver diskette for Windows2000/XP/XP64
2. Generate RAID Driver diskette for Windows2000/XP
3. Generate RAID Driver diskette for WindowsXP64
4. Exit

Reboot system now

Press any key to continue

Please insert a floppy diskette into the floppy drive. Select your required item on the list according to the mode you choose and the OS you install. Then press any key.

- E. The system will start to format the floppy diskette and copy SATA / SATAII drivers into the floppy diskette.

STEP 3: Install Windows® 2000 / XP / XP 64-bit OS on your system.

After making a SATA / SATAII driver diskette, you can start to install Windows® 2000 / XP / XP 64-bit on your system. At the beginning of Windows® setup, press F6 to install a third-party AHCI driver. When prompted, insert the SATA / SATAII driver diskette containing the NVIDIA® AHCI driver. After reading the floppy disk, the drivers will be presented. Select the driver to install according to the OS you install. The drivers are as below:

A. NVIDIA nForce Storage Controller (required) Windows XP/2000

B. NVIDIA nForce Storage Controller (required) Windows XP64

Please select A for Windows® 2000 / XP in AHCI mode. Please select B for Windows® XP 64-bit in AHCI mode.

Using SATA / SATAII HDDs and eSATAII devices without NCQ and Hot Plug functions

STEP 1: Set Up BIOS.

- A. Enter BIOS SETUP UTILITY → Advanced screen → IDE Configuration.
B. Set the “SATA Operation Mode” option to [non-RAID].

STEP 2: Install Windows® 2000 / XP / XP 64-bit OS on your system.

2.13.2 Installing Windows® Vista™ / Vista™ 64-bit Without RAID Functions

If you want to install Windows® Vista™ / Windows® Vista™ 64-bit on your SATA / SATAII HDDs without RAID functions, please follow below steps.

Using SATA / SATAII HDDs and eSATAII devices with NCQ and Hot Plug functions

STEP 1: Set Up BIOS.

- A. Enter BIOS SETUP UTILITY → Advanced screen → IDE Configuration.
B. Set the “SATA Operation Mode” option to [AHCI].

STEP 2: Install Windows® Vista™ / Vista™ 64-bit OS on your system.

Insert the Windows® Vista™ / Windows® Vista™ 64-bit optical disk into the optical drive to boot your system, and follow the instruction to install Windows® Vista™ / Windows® Vista™ 64-bit OS on your system. When you see “Where do you want to install Windows?” page, please insert the ASRock Support CD into your optical drive, and click the “Load Driver” button on the left on the bottom to load the NVIDIA® AHCI

drivers. NVIDIA® AHCI drivers are in the following path in our Support CD:

..\I386\ Vista32_AHCI (For Windows® Vista™ OS)

..\AMD64\ Vista64_AHCI (For Windows® Vista™ 64-bit OS)

After that, please insert Windows® Vista™ / Windows® Vista™ 64-bit optical disk into the optical drive again to continue the installation.

Using SATA / SATAII HDDs and eSATAII devices without NCQ and Hot Plug functions

STEP 1: Set Up BIOS.

- A. Enter BIOS SETUP UTILITY → Advanced screen → IDE Configuration.
- B. Set the "SATA Operation Mode" option to [non-RAID].

STEP 2: Install Windows® Vista™ / Vista™ 64-bit OS on your system.

2.14 Installing Windows® 2000 / XP / XP 64-bit / Vista™ / Vista™ 64-bit With RAID Functions

If you want to install Windows® 2000, Windows® XP, Windows® XP 64-bit, Windows® Vista™ or Windows® Vista™ 64-bit on your SATA / SATAII HDDs with RAID functions, please follow below procedures according to the OS you install.



1. The installation procedures for Windows® Vista™ / Vista™ 64-bit are subject to change. Please visit our website for the updates of Windows® Vista™ / Vista™ 64-bit driver and related information in the future.
2. Before installing Windows® 2000 to your system, your Windows® 2000 optical disk is supposed to include SP4. If there is no SP4 included in your disk, please visit the below website for proper procedures of making a SP4 disk:
http://www.microsoft.com/Windows2000/downloads/servicepacks/sp4/spdeploy.htm#the_integrated_installation_fmaj

2.14.1 Installing Windows® 2000 / XP / XP 64-bit With RAID Functions

If you want to install Windows® 2000 / Windows® XP / Windows® XP 64-bit on your SATA / SATAII HDDs with RAID functions, please follow below steps.

STEP 1: Set Up BIOS.

- A. Enter BIOS SETUP UTILITY → Advanced screen → IDE Configuration.
- B. Set the "SATA Operation Mode" option to [RAID].

STEP 2: Make a SATA / SATAII driver diskette.

Please make a SATA / SATAII driver diskette by following section 2.13.1 step 2 on page 31.



If you want to enable Hot Plug function on eSATAII ports but you install OS on IDE HDD, please skip step 2.

STEP 3: Use “RAID Installation Guide” to set RAID configuration.

Before you start to configure RAID function, you need to check the RAID installation guide in the Support CD for proper configuration. Please refer to the BIOS RAID installation guide part of the document in the following path in the Support CD:

.. \ RAID Installation Guide

STEP 4: Install Windows® 2000 / XP / XP 64-bit OS on your system.

After step 1, 2, 3, you can start to install Windows® 2000 / Windows® XP / Windows® XP 64-bit OS on your system. At the beginning of Windows® setup, press F6 to install a third-party RAID driver. When prompted, insert the SATA / SATAII driver diskette containing the NVIDIA® RAID driver. After reading the floppy disk, the drivers will be presented. Select the drivers to install. The drivers are as below:

A. NVIDIA RAID Driver (required)

B. NVIDIA nForce Storage Controller (required)

Please select A and B for Windows® 2000 / XP / XP 64-bit in RAID mode. (There are two RAID drivers needed for RAID mode, you have to select them separately. Please specify the first RAID driver and then specify again for the second one.)

NOTE. If you install Windows® 2000 / Windows® XP / Windows® XP 64-bit on IDE HDDs and want to manage (create, convert, delete, or rebuild) RAID functions on SATA / SATAII HDDs, you still need to set up “SATA Operation Mode” to [RAID] in BIOS first. Then, please set the RAID configuration by using the Windows RAID installation guide part of the document in the following path in the Support CD:
.. \ RAID Installation Guide

2.14.2 Installing Windows® Vista™ / Vista™ 64-bit With RAID Functions

If you want to install Windows® Vista™ / Windows® Vista™ 64-bit on your SATA / SATAII HDDs with RAID functions, please follow below steps.

STEP 1: Set Up BIOS.

- A. Enter BIOS SETUP UTILITY → Advanced screen → IDE Configuration.
- B. Set the “SATA Operation Mode” option to [RAID].

STEP 2: Use “RAID Installation Guide” to set RAID configuration.

Before you start to configure RAID function, you need to check the RAID installation guide in the Support CD for proper configuration. Please refer to the BIOS RAID installation guide part of the document in the following path in the Support CD:

.. \ RAID Installation Guide

STEP 3: Install Windows® Vista™ / Vista™ 64-bit OS on your system.

Insert the Windows® Vista™ / Windows® Vista™ 64-bit optical disk into the optical drive to boot your system, and follow the instruction to install Windows® Vista™ / Windows® Vista™ 64-bit OS on your system. When you see “Where do you want to

install Windows?" page, please insert the ASRock Support CD into your optical drive, and click the "Load Driver" button on the left on the bottom to load the NVIDIA® RAID drivers. NVIDIA® RAID drivers are in the following path in our Support CD:

..\ I386 \ Vista32_RAID (For Windows® Vista™ OS)

..\ AMD64 \ Vista64_RAID (For Windows® Vista™ 64-bit OS)

After that, please insert Windows® Vista™ / Windows® Vista™ 64-bit optical disk into the optical drive again to continue the installation.

NOTE. If you install Windows® Vista™ / Windows® Vista™ 64-bit on IDE HDDs and want to manage (create, convert, delete, or rebuild) RAID functions on SATA / SATAII HDDs, you still need to set up "SATA Operation Mode" to [RAID] in BIOS first. Then, please set the RAID configuration by using the Windows RAID installation guide in the following path in the Support CD:

..\ RAID Installation Guide

2.15 Untied Overclocking Technology

This motherboard supports Untied Overclocking Technology, which means during overclocking, FSB enjoys better margin due to fixed PCI / PCIE buses. Before you enable Untied Overclocking function, please enter "Overclock Mode" option of BIOS setup to set the selection from [Auto] to [CPU, PCIE, Async.]. Therefore, CPU FSB is untied during overclocking, but PCI / PCIE buses are in the fixed mode so that FSB can operate under a more stable overclocking environment.



Please refer to the warning on page 7 for the possible overclocking risk before you apply Untied Overclocking Technology.

3. BIOS SETUP UTILITY

3.1 Introduction

This section explains how to use the BIOS SETUP UTILITY to configure your system. The Flash Memory on the motherboard stores the BIOS SETUP UTILITY. You may run the BIOS SETUP UTILITY when you start up the computer. Please press <F2> during the Power-On-Self-Test (POST) to enter the BIOS SETUP UTILITY, otherwise, POST will continue with its test routines.

If you wish to enter the BIOS SETUP UTILITY after POST, restart the system by pressing <Ctl> + <Alt> + <Delete>, or by pressing the reset button on the system chassis. You may also restart by turning the system off and then back on.



Because the BIOS software is constantly being updated, the following BIOS setup screens and descriptions are for reference purpose only, and they may not exactly match what you see on your screen.

3.1.1 BIOS Menu Bar

The top of the screen has a menu bar with the following selections:

- Main** To set up the system time/date information
- Advanced** To set up the advanced BIOS features
- H/W Monitor** To display current hardware status
- Boot** To set up the default system device to locate and load the Operating System
- Security** To set up the security features
- Exit** To exit the current screen or the BIOS SETUP UTILITY

Use <←> key or <→> key to choose among the selections on the menu bar, and then press <Enter> to get into the sub screen.

3.1.2 Navigation Keys

Please check the following table for the function description of each navigation key.

Navigation Key(s)	Function Description
← / →	Moves cursor left or right to select Screens
↑ / ↓	Moves cursor up or down to select items
+ / -	To change option for the selected items
<Enter>	To bring up the selected screen
<F1>	To display the General Help Screen
<F9>	To load optimal default values for all the settings
<F10>	To save changes and exit the BIOS SETUP UTILITY
<ESC>	To jump to the Exit Screen or exit the current screen

3.2 Main Screen

When you enter the BIOS SETUP UTILITY, the Main screen will appear and display the system overview.

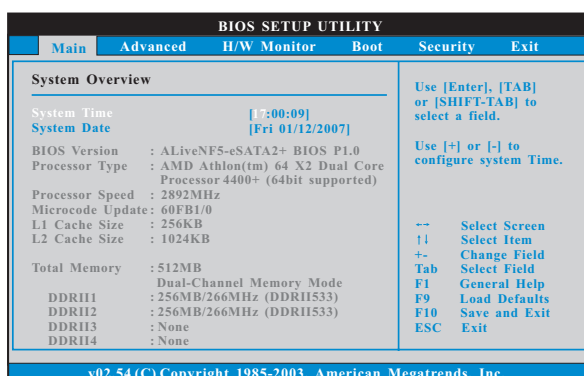

System Time [Hour:Minute:Second]

Use this item to specify the system time.

System Date [Day Month/Date/Year]

Use this item to specify the system date.

3.3 Advanced Screen

In this section, you may set the configurations for the following items: CPU Configuration, Chipset Configuration, ACPI Configuration, IDE Configuration, PCIPnP Configuration, Floppy Configuration, SuperIO Configuration, and USB Configuration.

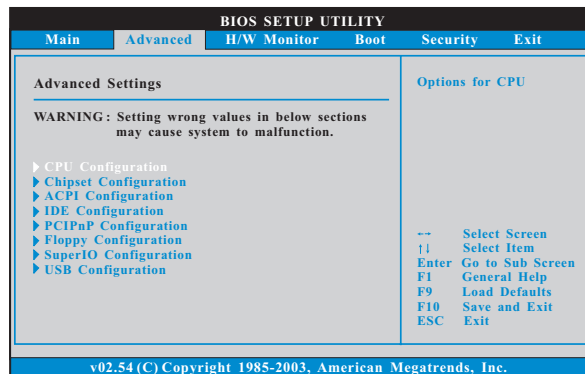

Setting wrong values in this section may cause the system to malfunction.

3.3.1 CPU Configuration

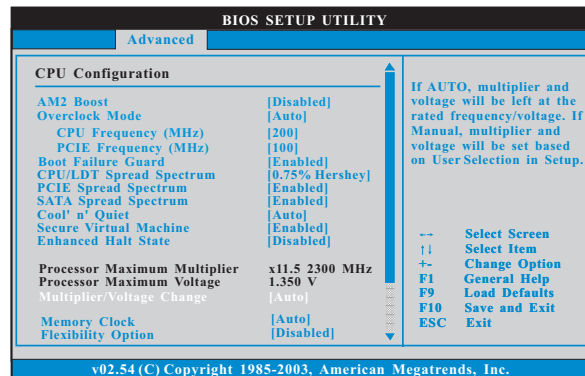

AM2 Boost

If you set this option to [Enabled], you will enable ASRock AM2 Boost function, which will improve the memory performance. The default value is [Disabled]. Please refer to caution 7 on page 8 for details.

Overclock Mode

Use this to select Overclock Mode. The default value is [Auto]. Configuration options: [Auto], [CPU, PCIE, Sync.] and [CPU, PCIE, Async.].

CPU Frequency (MHz)

Use this option to adjust CPU frequency. The default value is [200].

PCIe Frequency (MHz)

Use this option to adjust PCIe frequency. The default value is [100].

Boot Failure Guard

Enable or disable the feature of Boot Failure Guard.

CPU/LDT Spread Spectrum

This feature will be set to [0.75% Hershey] as default. Configuration options: [Disabled], [0.5% Hershey], [0.75% Hershey], [0.5% Triangular], and [0.75% Triangular].

PCIe Spread Spectrum

This feature will be set to [Enabled] as default. Configuration options: [Disabled], and [Enabled].

SATA Spread Spectrum

This feature will be set to [Enabled] as default. Configuration options: [Disabled], and [Enabled].

Cool 'n' Quiet

Use this item to enable or disable AMD's Cool 'n' Quiet™ technology. The default value is [Auto]. Configuration options: [Auto], [Enabled] and [Disabled]. If you install Windows® Vista™ and want to enable this function, please set this item to [Enabled]. Please note that enabling this function may reduce CPU voltage and memory frequency, and lead to system stability or compatibility issue with some memory modules or power supplies. Please set this item to [Disable] if above issue occurs.

Secure Virtual Machine

When this option is set to [Enabled], a VMM (Virtual Machine Architecture) can utilize the additional hardware capabilities provided by AMD-V. The default value is [Enabled]. Configuration options: [Enabled] and [Disabled].

Enhanced Halt State

This item only appears when you install Rev. G Dual Core AM2 CPU on this motherboard. C1E is an enhanced power saving state which is supported by AM2 dual core processors. The processor will enter C1E power saving state when both of its cores transition into the C1 state. The default value is [Disabled]. Configuration options: [Enabled] and [Disabled].

Processor Maximum Multiplier

It will display Processor Maximum Multiplier for reference.

Processor Maximum Voltage

It will display Processor Maximum Voltage for reference.

Multiplier/Voltage Change

This item is set to [Auto] by default. If it is set to [Manual], you may adjust the value of Processor Multiplier and Processor Voltage. However, it is recommended to keep the default value for system stability.

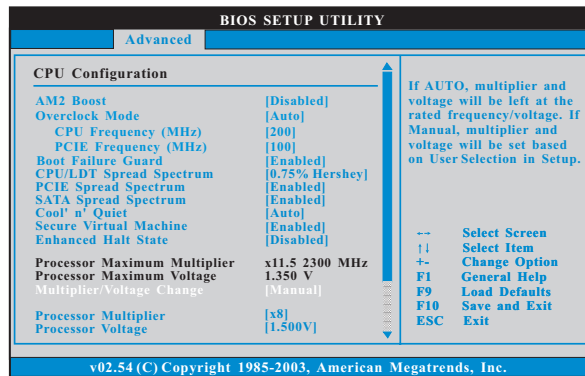

Processor Multiplier

This item will show when "Multiplier/Voltage Change" is set to [Manual]; otherwise, it will be hidden. The range of the value depends on the CPU you adopt on this motherboard. However, for system stability, it is not recommended to adjust the value of this item.

Processor Voltage

This item will show when "Multiplier/Voltage Change" is set to [Manual]; otherwise, it will be hidden. The range of the value depends on the CPU you adopt on this motherboard. However, for safety and system stability, it is not recommended to adjust the value of this item.

Memory Clock

This item can be set by the code using [Auto]. You can set one of the standard values as listed: [200 MHz (DDRII 400)], [266 MHz (DDRII 533)], [333 MHz (DDRII 667)], and [400MHz (DDRII 800)].

Flexibility Option

The default value of this option is [Disabled]. It will allow better tolerance for memory compatibility when it is set to [Enabled].

CAS Latency (CL)

Use this item to adjust the means of memory accessing. Configuration options: [Auto], [3T], [4T], [5T], and [6T]. The default value is [Auto].

TRAS

Use this to adjust TRAS values. Configuration options: [Auto], [5CLK], [6CLK], [7CLK], [8CLK], [9CLK], [10CLK], [11CLK], [12CLK], [13CLK], [14CLK], [15CLK], [16CLK], [17CLK], and [18CLK]. The default value is [Auto].

TRP

Use this to adjust TRP values. Configuration options: [Auto], [3CLK], [4CLK], [5CLK], and [6CLK]. The default value is [Auto].

TRCD

Use this to adjust TRCD values. Configuration options: [Auto], [3CLK], [4CLK], [5CLK], and [6CLK]. The default value is [Auto].

TRRD

Use this to adjust TRRD values. Configuration options: [Auto], [2T], [3T], [4T], and [5T]. The default value is [Auto].

TRC

Use this to adjust TRC values. Configuration options: [11T] to [26T]. The default value is [Auto].

MA Timing

Use this to adjust values for MA timing. Configuration options: [Auto], [2T], [1T]. The default value is [Auto].

Bank Interleaving

Interleaving allows memory accesses to be spread out over banks on the same node, or across nodes, decreasing access contention.

3.3.2 Chipset Configuration

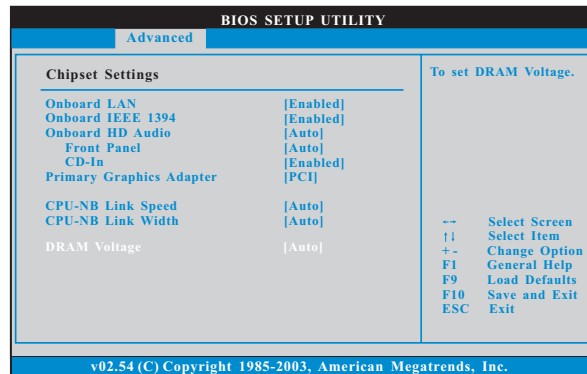

OnBoard LAN

This allows you to enable or disable the onboard LAN feature.

OnBoard IEEE 1394

This allows you to enable or disable the onboard IEEE 1394 feature.

OnBoard HD Audio

Select [Auto], [Enabled] or [Disabled] for the onboard HD Audio feature. If you select [Auto], the onboard HD Audio will be disabled when PCI Sound Card is plugged.

Front Panel

Select [Auto], [Enabled] or [Disabled] for the onboard HD Audio Front Panel.

CD-In

Use this item to enable or disable CD-In of OnBoard HD Audio. If you plan to use this motherboard to submit Windows® Vista™ logo test, please disable this option.

Primary Graphics Adapter

This item will switch the PCI Bus scanning order while searching for video card. It allows you to select the type of Primary VGA in case of multiple video controllers. The default value of this feature is [PCI]. Configuration options: [PCI] and [PCI Express].

CPU - NB Link Speed

This feature allows you selecting CPU to NB link frequency. Configuration options: [Auto], [200 MHz], [400 MHz], [600 MHz], [800 MHz], and [1000 MHz].

CPU - NB Link Width

This feature allows you selecting CPU to NB link width. Configuration options: [Auto], [8 bit], and [16 bit].

DRAM Voltage

Use this to select DRAM voltage. Configuration options: [Auto], [1.85], [1.9], [1.95], [2] and [2.05]. The default value is [Auto].

3.3.3 ACPI Configuration

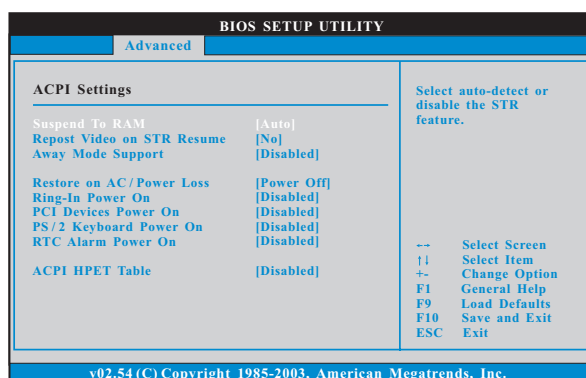

Suspend to RAM

Use this item to select whether to auto-detect or disable the Suspend-to-RAM feature. Select [Auto] will enable this feature if the OS supports it. If you set this item to [Disabled], the function "Repost Video on STR Resume" will be hidden.

Repost Video on STR Resume

This feature allows you to repost video on STR resume. (STR refers to suspend to RAM.)

Away Mode Support

Use this item to enable or disable Away Mode support under Windows® XP Media Center OS. The default value is [Disabled].

Restore on AC/Power Loss

This allows you to set the power state after an unexpected AC/power loss. If [Power Off] is selected, the AC/power remains off when the power recovers. If [Power On] is selected, the AC/power resumes and the system starts to boot up when the power recovers.

Ring-In Power On

Use this item to enable or disable Ring-In signals to turn on the system from the power-soft-off mode.

PCI Devices Power On

Use this item to enable or disable PCI devices to turn on the system from the power-soft-off mode.

PS/2 Keyboard Power On

Use this item to enable or disable PS/2 keyboard to turn on the system from the power-soft-off mode.

RTC Alarm Power On

Use this item to enable or disable RTC (Real Time Clock) to power on the system.

ACPI HPET Table

Use this item to enable or disable ACPI HPET Table. The default value is [Disabled]. Please set this option to [Enabled] if you plan to use this motherboard to submit Windows® Vista™ certification.

3.3.4 IDE Configuration

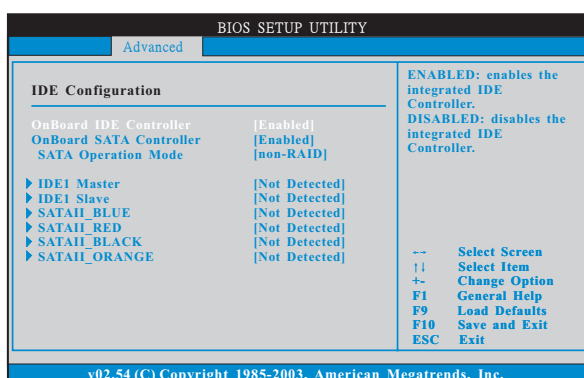

OnBoard IDE Controller

Use this item to enable or disable the “OnBoard IDE Controller” feature.

OnBoard SATA Controller

Use this item to enable or disable the “OnBoard SATA Controller” feature.

SATA Operation Mode

Use this item to adjust SATA Operation Mode. The default value of this option is [non-RAID]. If you want to operate RAID function on SATA / SATAII HDDs, please select [RAID].

* If you select [RAID] mode, SATA / SATAII HDDs can not be accessed until you finish configuring RAID functions in NVIDIA BIOS / Windows RAID Utility.

eSATAII Support

Use this item to enable or disable eSATAII support. This item appears only when “SATA Operation Mode” is set to [RAID]. The default value is [Enabled]. Configuration options: [Enabled] and [Disabled]. If you set this item to [Enabled], eSATAII ports cannot support RAID functions. If you set this item to [Disabled], eSATAII ports can support RAID functions.

IDE Device Configuration

You may set the IDE configuration for the device that you specify. We will use the “IDE Master” as the example in the following instruction, which can be applied to the configurations of “IDE Slave” as well.

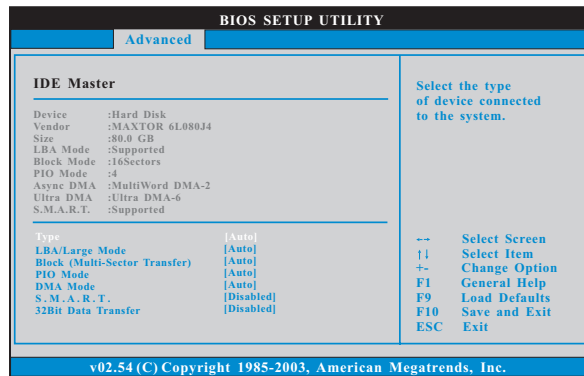

TYPE

Use this item to configure the type of the IDE device that you specify. Configuration options: [Not Installed], [Auto], [CD/DVD], and [ARMD].

[Not Installed]: Select [Not Installed] to disable the use of IDE device.

[Auto]: Select [Auto] to automatically detect the hard disk drive.



After selecting the hard disk information into BIOS, use a disk utility, such as FDISK, to partition and format the new IDE hard disk drives. This is necessary so that you can write or read data from the hard disk. Make sure to set the partition of the Primary IDE hard disk drives to active.

[CD/DVD]: This is used for IDE CD/DVD drives.

[ARMD]: This is used for IDE ARMD (ATAPI Removable Media Device), such as MO.

LBA/Large Mode

Use this item to select the LBA/Large mode for a hard disk > 512 MB under DOS and Windows; for Netware and UNIX user, select [Disabled] to disable the LBA/Large mode.

Block (Multi-Sector Transfer)

The default value of this item is [Auto]. If this feature is enabled, it will enhance hard disk performance by reading or writing more data during each transfer.

PIO Mode

Use this item to set the PIO mode to enhance hard disk performance by optimizing the hard disk timing.

DMA Mode

DMA capability allows the improved transfer-speed and data-integrity for compatible IDE devices.

S.M.A.R.T.

Use this item to enable or disable the S.M.A.R.T. (Self-Monitoring, Analysis, and Reporting Technology) feature. Configuration options: [Disabled], [Auto], [Enabled].

32Bit Data Transfer

Use this item to enable 32-bit access to maximize the IDE hard disk data transfer rate.

3.3.5 PCIPnP Configuration

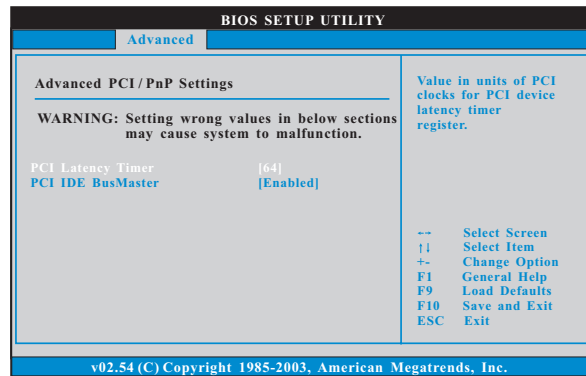

Setting wrong values in this section may cause the system to malfunction.

PCI Latency Timer

The default value is 32. It is recommended to keep the default value unless the installed PCI expansion cards' specifications require other settings.

PCI IDE BusMaster

Use this item to enable or disable the PCI IDE BusMaster feature.

3.3.6 Floppy Configuration

In this section, you may configure the type of your floppy drive.

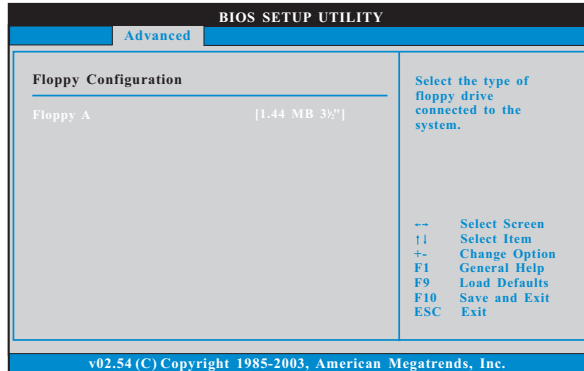

3.3.7 Super IO Configuration

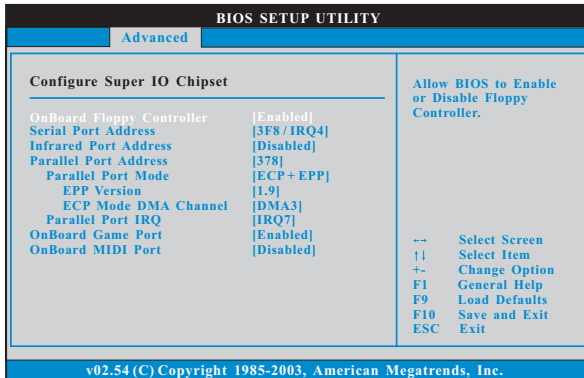

OnBoard Floppy Controller

Use this item to enable or disable floppy drive controller.

Serial Port Address

Use this item to set the address for the onboard serial port or disable it.

Configuration options: [Disabled], [3F8 / IRQ4], [2F8 / IRQ3], [3E8 / IRQ4], [2E8 / IRQ3].

Infrared Port Address

Use this item to set the address for the onboard infrared port or disable it.

Configuration options: [Disabled], [2F8 / IRQ3], and [2E8 / IRQ3].

Parallel Port Address

Use this item to set the address for the onboard parallel port or disable it. Configuration options: [Disabled], [378], and [278].

Parallel Port Mode

Use this item to set the operation mode of the parallel port. The default value is [ECP+EPP]. If this option is set to [ECP+EPP], it will show the EPP version in the following item, "EPP Version". Configuration options: [Normal], [Bi-Directional], and [ECP+EPP].

EPP Version

Use this item to set the EPP version. Configuration options: [1.9] and [1.7].

ECP Mode DMA Channel

Use this item to set the ECP mode DMA channel. Configuration options: [DMA0], [DMA1], and [DMA3].

Parallel Port IRQ

Use this item to set the IRQ for the parallel port. Configuration options: [IRQ5] and [IRQ7].

OnBoard Game Port

Use this item to enable the Game Port or disable it.

OnBoard MIDI Port

Use this item to select the address for the MIDI Port or disable it. Configuration options: [Disabled], [300], and [330].

3.3.8 USB Configuration

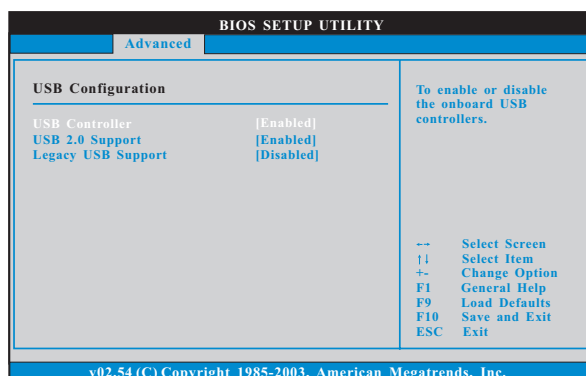

USB Controller

Use this item to enable or disable the use of USB controller.

USB 2.0 Support

Use this item to enable or disable the USB 2.0 support.

Legacy USB Support

Use this item to enable or disable the support to emulate the I/O devices of legacy OS (DOS) such as mouse, keyboard, USB flash... etc. Or you may select [Auto] so that the system will start to auto-detect; if there is no USB device connected, "Auto" option will disable the legacy USB support.

3.4 Hardware Health Event Monitoring Screen

In this section, it allows you to monitor the status of the hardware on your system, including the parameters of the CPU temperature, motherboard temperature, CPU fan speed, chassis fan speed, and the critical voltage.

BIOS SETUP UTILITY					
Main	Advanced	H/W Monitor	Boot	Security	Exit
Hardware Health Event Monitoring			You are allowed to enable this function only when you install 4-pin CPU fan.		
CPU Ambient Temperature	:	42°C / 107°F			
CPU Internal Temperature	:	52°C / 125°F			
M/B Temperature	:	31°C / 87°F			
CPU Fan Speed	:	2833 RPM			
Chassis Fan Speed	:	N/A			
Vcore	:	1.532 V			
+ 3.30V	:	3.129 V			
+ 5.00V	:	4.877 V			
+ 12.00V	:	11.741 V			
CPU Quiet Fan	:	[Disabled]			
			--	Select Screen	
			↑↓	Select Item	
			F1	General Help	
			F9	Load Defaults	
			F10	Save and Exit	
			ESC	Exit	

v02.54 (C) Copyright 1985-2003, American Megatrends, Inc.

CPU Ambient Temperature

This item shows the temperature sensed by thermistor near CPU.

CPU Internal Temperature

This item shows the temperature sensed by dual current source CPU.

CPU Quiet Fan

This item allows you to identify the temperature of CPU fan. Configuration options: [Disabled] and [Enabled]. The default value is [Disabled]. You are allowed to enable this function only when you install 4-pin CPU fan.

3.5 Boot Screen

In this section, it will display the available devices on your system for you to configure the boot settings and the boot priority.

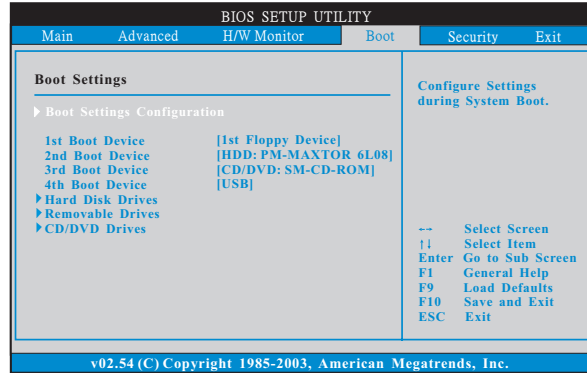

3.5.1 Boot Settings Configuration

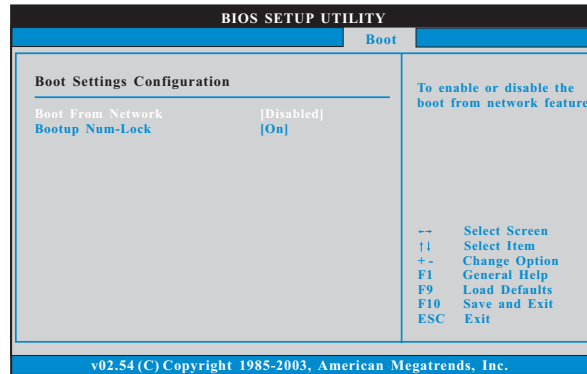

Boot From Network

Use this item to enable or disable the Boot From Network feature.

Boot Up Num-Lock

If this item is set to [On], it will automatically activate the Numeric Lock function after boot-up.

3.6 Security Screen

In this section, you may set or change the supervisor/user password for the system. For the user password, you may also clear it.

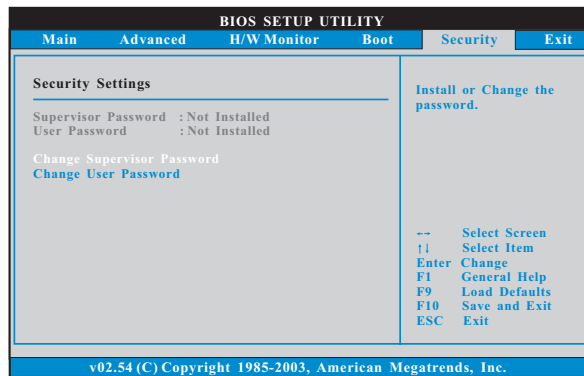

3.7 Exit Screen

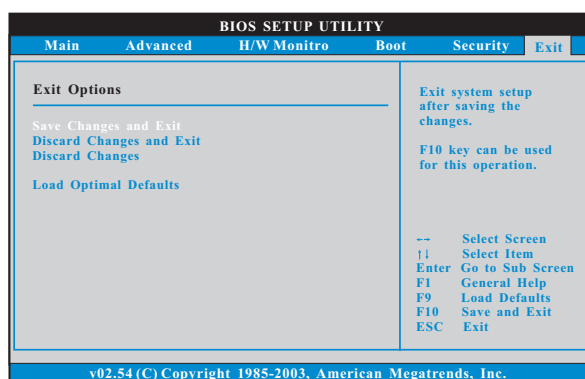

Save Changes and Exit

When you select this option, it will pop-out the following message, “Save configuration changes and exit setup?” Select [OK] to save the changes and exit the BIOS SETUP UTILITY.

Discard Changes and Exit

When you select this option, it will pop-out the following message, “Discard changes and exit setup?” Select [OK] to exit the BIOS SETUP UTILITY without saving any changes.

Discard Changes

When you select this option, it will pop-out the following message, “Discard changes?” Select [OK] to discard all changes.

Load Optimal Defaults

When you select this option, it will pop-out the following message, “Load optimal defaults?” Select [OK] to load the default values for all the setup configurations.

4. Software Support

4.1 Install Operating System

This motherboard supports various Microsoft® Windows® operating systems: 2000 / XP / XP Media Center / XP 64-bit / Vista™ / Vista™ 64-bit. Because motherboard settings and hardware options vary, use the setup procedures in this chapter for general reference only. Refer to your OS documentation for more information.

4.2 Support CD Information

The Support CD that came with the motherboard contains necessary drivers and useful utilities that enhance the motherboard features.

4.2.1 Running The Support CD

To begin using the support CD, insert the CD into your CD-ROM drive. The CD automatically displays the Main Menu if "AUTORUN" is enabled in your computer. If the Main Menu did not appear automatically, locate and double click on the file "ASSETUP.EXE" from the BIN folder in the Support CD to display the menus.

4.2.2 Drivers Menu

The Drivers Menu shows the available devices drivers if the system detects the installed devices. Please install the necessary drivers to activate the devices.

4.2.3 Utilities Menu

The Utilities Menu shows the applications software that the motherboard supports. Click on a specific item then follow the installation wizard to install it.

4.2.4 Contact Information

If you need to contact ASRock or want to know more about ASRock, welcome to visit ASRock's website at <http://www.asrock.com>; or you may contact your dealer for further information.

APPENDIX:

AMD's Cool 'n' Quiet™ Technology

For power-saving sake, it is strongly recommended to enable AMD's Cool 'n' Quiet™ technology under Windows® system. When using this feature, please make sure to install "AMD Processor Driver" from the "Support CD" first.

If you are using Windows® 2000/XP operating system, please follow the instruction below to enable AMD's Cool 'n' Quiet™ technology:

1. From the Windows® 2000/XP operating system, click the Start button. Select Settings, then Control Panel.
2. Switch to Classic View. (for Windows® XP only)
3. Double-click the Display icon in the Control Panel then select the Screen Saver tab.
4. Click the "Power..." button. The following dialog box appears.
5. From the Power schemes combo list box, select **Minimal Power Management**.
6. Click OK to implement settings.