



SBC-350

User Manual

Version 1.1

Updated September 28, 2020

Copyright©2020 ASRockInd INC. All rights reserved.

---

Version 1.1

Updated September 28, 2020

Copyright©2020 ASRock INC. All rights reserved.

### Copyright Notice:

No part of this documentation may be reproduced, transcribed, transmitted, or translated in any language, in any form or by any means, except duplication of documentation by the purchaser for backup purpose, without written consent of ASRockInd Inc.

Products and corporate names appearing in this documentation may or may not be registered trademarks or copyrights of their respective companies, and are used only for identification or explanation and to the owners' benefit, without intent to infringe.

### Disclaimer:

Specifications and information contained in this documentation are furnished for informational use only and subject to change without notice, and should not be constructed as a commitment by ASRockInd. ASRockInd assumes no responsibility for any errors or omissions that may appear in this documentation.

With respect to the contents of this documentation, ASRockInd does not provide warranty of any kind, either expressed or implied, including but not limited to the implied warranties or conditions of merchantability or fitness for a particular purpose.

In no event shall ASRockInd, its directors, officers, employees, or agents be liable for any indirect, special, incidental, or consequential damages (including damages for loss of profits, loss of business, loss of data, interruption of business and the like), even if ASRockInd has been advised of the possibility of such damages arising from any defect or error in the documentation or product.



This device complies with Part 15 of the FCC Rules. Operation is subject to the following two conditions:

- (1) this device may not cause harmful interference, and
- (2) this device must accept any interference received, including interference that may cause undesired operation.

### CALIFORNIA, USA ONLY

The Lithium battery adopted on this motherboard contains Perchlorate, a toxic substance controlled in Perchlorate Best Management Practices (BMP) regulations passed by the California Legislature. When you discard the Lithium battery in California, USA, please follow the related regulations in advance.

“Perchlorate Material-special handling may apply, see [www.dtsc.ca.gov/hazardouswaste/perchlorate](http://www.dtsc.ca.gov/hazardouswaste/perchlorate)”

**ASRockInd Website: <http://www.asrockind.com>**

---

# Contents

<b>1</b>	<b>Introduction .....</b>	<b>5</b>
1.1	Package Contents .....	5
1.2	Specifications.....	6
1.3	Motherboard Layout.....	8
1.4	I/O Panel.....	10
<b>2</b>	<b>Installation .....</b>	<b>11</b>
2.1	Screw Holes.....	11
2.2	Pre-installation Precautions .....	11
2.3	Installation of Memory Modules (SO-DIMM).....	12
2.4	Expansion Slots .....	13
2.5	Jumpers Setup.....	14
2.6	Onboard Headers and Connectors.....	16
<b>3</b>	<b>UEFI SETUP UTILITY.....</b>	<b>21</b>
3.1	Introduction.....	21
3.1.1	UEFI Menu Bar .....	21
3.1.2	Navigation Keys.....	22
3.2	Main Screen.....	22
3.3	Advanced Screen.....	23
3.3.1	CPU Configuration.....	24
3.3.2	Chipset Configuration .....	26
3.3.3	Storage Configuration.....	28
3.3.4	Super IO Configuration .....	29
3.3.5	AMT Configuration .....	30
3.3.6	ACPI Configuration .....	32
3.3.7	USB Configuration .....	33
3.3.8	Trusted Computing .....	34
3.4	Hardware Health Event Monitoring Screen .....	35
3.5	Security Screen .....	36
3.6	Boot Screen .....	37
3.7	Exit Screen .....	39

---

<b>4 Software Support .....</b>	<b>40</b>
4.1 Install Operating System.....	40
4.2 Support CD Information.....	40
4.2.1 Running Support CD.....	40
4.2.2 Drivers Menu .....	40
4.2.3 Utilities Menu .....	40
4.2.4 Contact Information .....	40

---

# Chapter 1: Introduction

Thank you for purchasing ASRockInd **SBC-350** motherboard, a reliable motherboard produced under ASRockInd's consistently stringent quality control. It delivers excellent performance with robust design conforming to ASRockInd's commitment to quality and endurance.

In this manual, chapter 1 and 2 contain introduction of the motherboard and step-by-step guide to the hardware installation. Chapter 3 and 4 contain the configuration guide to BIOS setup and information of the Support CD.



Because the motherboard specifications and the BIOS software might be updated, the content of this manual will be subject to change without notice. In case any modifications of this manual occur, the updated version will be available on ASRockInd website without further notice. You may find the latest CPU support lists on ASRockInd website as well.

ASRockInd website <https://www.asrockind.com/>

If you require technical support related to this motherboard, please visit our website for specific information about the model you are using.

<https://www.asrockind.com/support/index.asp>

## 1.1 Package Contents

ASRockInd **SBC-350** Motherboard (3.5" SBC (6.3-in x 4.0-in))

ASRockInd **SBC-350** Driver CD

ASRockInd **SBC-350** Jumper Setting Instruction

## 1.2 Specifications

<b>Form Factor</b>	Dimensions	3.5" SBC (6.3-in x 4.0-in)
<b>Processor System</b>	CPU	Intel® 8 <sup>th</sup> Gen (Whiskey lake-U) Core™ MCP Processors - SBC-350P (i7-8665UE, QC, 1.7GHz, 15 W) - SBC-350M (i5-8365UE, QC, 1.6GHz, 15 W) - SBC-350V (i3-8145UE, DC, 2.2GHz, 15W)
	Chipset	SoC
<b>Expansion Slot</b>	PCIe	N/A
	Mini-PCIe	N/A
	mSATA	N/A
	M.2	- 1 x Key M (2242/2280) with PCIe x4 and SATA3 for SSD - 1 x Key M (2242) with SATA3 for SSD - 1 x Key E (2230) with PCIe x1, CNVI and USB 2.0 for Wireless
<b>Memory</b>	Technology	Dual Channel DDR4 2400 MHz
	Max.	32GB
	Socket	2 x SO-DIMM
<b>Graphics</b>	VGA	N/A
	LVDS	1920x1200@60Hz
	DisplayPort	DisplayPort++ 1.2 with max resolution up to 4096x2304@60Hz
	Multi Display	Yes (Triple Display)
<b>Ethernet</b>	Interface	10/100/1000 Mbps
	Controller	SBC-350P/M(vPro): 1 x Intel® I219LM (For i7 and i5 CPUs), 1 x Intel® I210 SBC-350V: 1 x Intel® I219V (For i3 CPU), 1 x Intel® I210
<b>Rear I/O</b>	VGA	N/A
	DVI	N/A
	HDMI	N/A
	DisplayPort	2
	Ethernet	2
	USB	4 x USB3.1
	Audio	N/A
	Serial	N/A
PS/2	N/A	

<b>Internal Connector</b>	USB	2 x USB 2.0, 2 x USB 3.1
	LVDS/ Inverter	1
	eDP	0
	VGA	0
	Serial	1 x COM (RS232/422/485), 3 x COM (RS232)
	SATA	1 x SATA3 (6.0 Gb/s)
	Parallel	0
	GPIO	4 x GPI, 4 x GPO
	SATA PWR Output Con	1
	Speaker Header	1
	TPM	SBC-350P/M: 1 x TPM 2.0 IC onboard SBC-350V: 1 x TPM 2.0 (For i3 CPU with BIOS setting)
<b>Watchdog Timer</b>	Output	Output from super I/O to drag RESETCON#
	Interval	256 Segments, 0,1,2...255 Sec
<b>Power Requirements</b>	Input PWR	9V~36V (Default) 12V only (by BOM option)
	Power On	AT/ATX Supported AT: Directly PWR on as power input ready ATX: Press button to PWR on after power input ready
<b>Environment</b>	Temperature	0°C – 60°C
	Storage Temp	-40°C – 85°C

### 1.3 Motherboard Layout

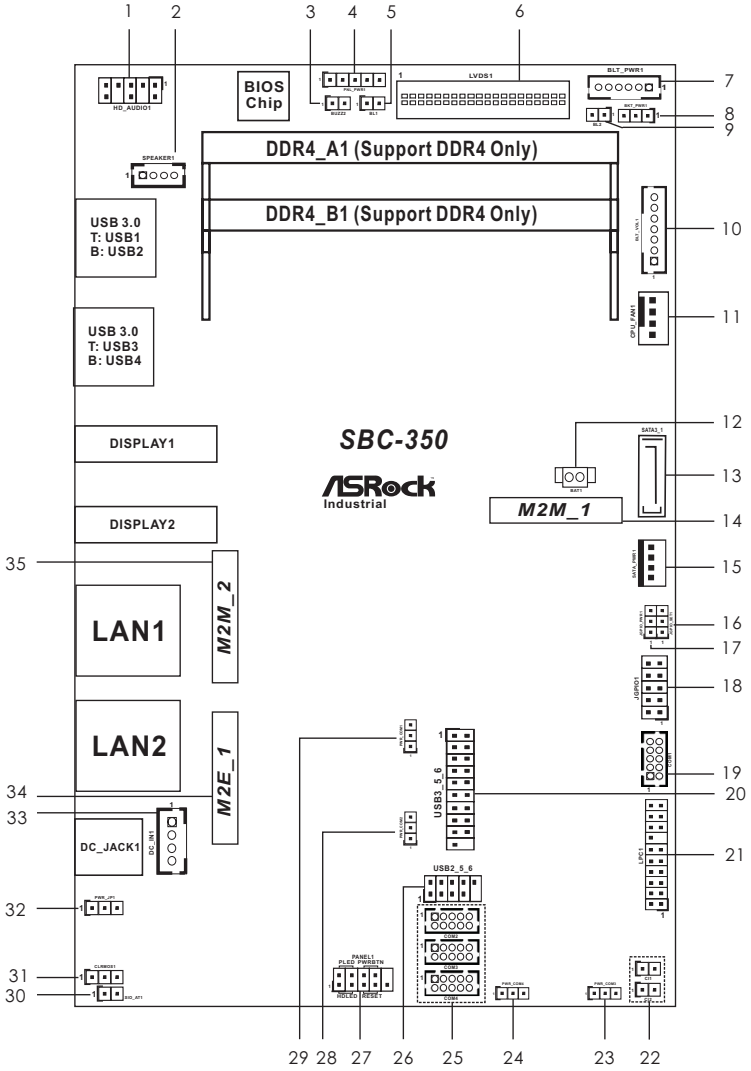



- 
- 1 : Front Panel Audio Header
  - 2 : 3W Audio AMP Output Wafer
  - 3 : Buzzer
  - 4 : Panel Power Select (LCD\_VCC) (PNL\_PWR1)
  - 5 : BL1
  - 6 : LVDS Panel Connector
  - 7 : Inverter Power Control Wafer (BLT\_PWR1)
  - 8 : Backlight Power Select (LCD\_BLT\_VCC) (BKT\_PWR1)
  - 9 : BL2
  - 10 : Backlight & Amp Volume Control (BLT\_VOL1)
  - 11 : 4-Pin CPU FAN Connector (+12V)
  - 12 : Battery Connector
  - 13 : SATA3 Connector (SATA3\_1)
  - 14 : M.2 Key-M Socket (M2M\_1)
  - 15 : SATA Power Output Connector
  - 16 : GPIO Default Setting (JGPIO\_SET1)
  - 17 : Digital Input / Output Power Select (JGPIO\_PWR1)
  - 18 : Digital Input / Output Pin Header (JGPIO1)
  - 19 : COM Port Header (COM1)
  - 20 : USB3.0 Connector (USB3\_5\_6)
  - 21 : LPC Header
  - 22 : Chassis Intrusion Headers (CI1, CI2)
  - 23 : COM Port Pin9 PWR Setting Jumper (PWR\_COM3 (For COM Port3))
  - 24 : COM Port Pin9 PWR Setting Jumper (PWR\_COM4 (For COM Port4))
  - 25 : COM Port Headers (COM2, 3, 4)
  - 26 : USB2.0 Connector (USB2\_5\_6)
  - 27 : System Panel Header
  - 28 : COM Port Pin9 PWR Setting Jumper (PWR\_COM2 (For COM Port2))
  - 29 : COM Port Pin9 PWR Setting Jumper (PWR\_COM1 (For COM Port1))
  - 30 : SIO\_AT1
  - 31 : Clear CMOS Header (CLRMOS1)
  - 32 : ATX/AT Mode Select (PWR\_JP1)
  - 33 : ATX Power Connector  
(Input 9V-36V (Default); 12V only (by BOM option))
  - 34 : M.2 Key-E Socket (M2E\_1)
  - 35 : M.2 Key-M Socket (M2M\_2)

## 1.4 I/O Panel

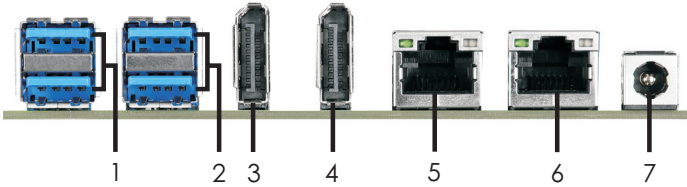

- |   |                       |   |                        |
|---|-----------------------|---|------------------------|
| 1 | USB 3.1 Ports (USB12) | 5 | LAN RJ-45 Port (LAN1)* |
| 2 | USB 3.1 Ports (USB34) | 6 | LAN RJ-45 Port (LAN2)* |
| 3 | DisplayPort 1.2 (DP1) | 7 | DC Jack (DC_JACK1)     |
| 4 | DisplayPort 1.2 (DP2) |   |                        |

\* There are two LED next to the LAN port. Please refer to the table below for the LAN port LED indications.

### LAN Port LED Indications

Activity/Link LED	
Status	Description
Off	No Link
Blinking	Data Activity
On	Link

SPEED LED	
Status	Description
Off	10Mbps connection
Yellow	100Mbps connection
Green	1Gbps connection

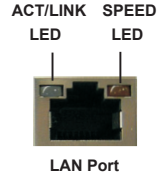

---

## Chapter 2: Installation

This is a 3.5" SBC (6.3-in x 4.0-in) form factor motherboard. Before you install the motherboard, study the configuration of your chassis to ensure that the motherboard fits into it.



Make sure to unplug the power cord before installing or removing the motherboard. Failure to do so may cause physical injuries to you and damages to motherboard components.

### 2.1 Screw Holes

Place screws into the holes to secure the motherboard to the chassis.



Do not over-tighten the screws! Doing so may damage the motherboard.

### 2.2 Pre-installation Precautions

Take note of the following precautions before you install motherboard components or change any motherboard settings.

1. Unplug the power cord from the wall socket before touching any component.
2. To avoid damaging the motherboard components due to static electricity, NEVER place your motherboard directly on the carpet or the like. Also remember to use a grounded wrist strap or touch a safety grounded object before you handle components.
3. Hold components by the edges and do not touch the ICs.
4. Whenever you uninstall any component, place it on a grounded antistatic pad or in the bag that comes with the component.
5. **Heatsink (The thermal solution of whole system needs to be designed additionally.)**



Before you install or remove any component, ensure that the power is switched off or the power cord is detached from the power supply. Failure to do so may cause severe damage to the motherboard, peripherals, and/or components.

---

## 2.3 Installation of Memory Modules (SO-DIMM)

**SBC-350** provides two 204-pin DDR4 (Double Data Rate 4) SO-DIMM slots.

- Step 1. Align a SO-DIMM on the slot such that the notch on the SO-DIMM matches the break on the slot.

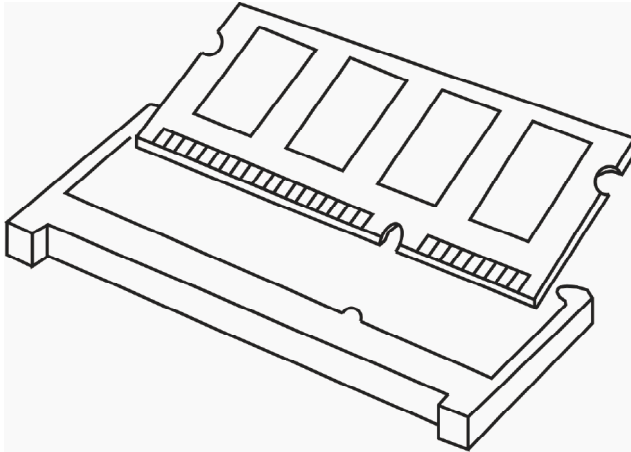

1. The SO-DIMM only fits in one correct orientation. It will cause permanent damage to the motherboard and the SO-DIMM if you force the SO-DIMM into the slot at incorrect orientation.
2. Please do not intermix different voltage SO-DIMMs on this motherboard.

- Step 2. Firmly insert the SO-DIMM into the slot until the retaining clips at both ends fully snap back in place and the SO-DIMM is properly seated.

## 2.4 Expansion Slots (M.2 Sockets)

There are 3 M.2 sockets on this motherboard.

### M.2 Key-M Socket (M2M\_1):

Key M (2242/2280) with PCIe x4 and SATA3 for SSD

Pin	Signal	Signal	Pin
1	GND	+3.3V	2
3	GND	+3.3V	4
5	PERP0	NA	6
7	PERP3	NA	8
9	GND	SATA_LED	10
11	PERP0	+3.3V	12
13	PETP3	+3.3V	14
15	GND	+3.3V	16
17	PERP2	+3.3V	18
19	PERP2	NA	20
21	GND	NA	22
23	PETN2	NA	24
25	PERP2	NA	26
27	GND	NA	28
29	PERN1	NA	30
31	PERP1	NA	32
33	GND	NA	34
35	PETN1	NA	36
37	PETP1	DEVSLP	38
39	GND	SMB_CLK	40
41	PERP0/SATA-B+	SMB_DATA	42
43	PERP0/SATA-B-	NA	44
45	GND	NA	46
47	PETN0/SATA-A-	NA	48
49	PETP0/SATA-A+	PERST#	50
51	GND	CLKREQ#	52
53	PEFCLK	WAKE#	54
55	PEFCLKp	NA	56
57	GND	NA	58
67	NA	NA	68
69	PEDET	+3.3V	70
71	GND	+3.3V	72
73	GND	+3.3V	74
75	GND		

### M.2 Key-M Socket (M2M\_2):

Key M (2242) with SATA3 for SSD

Pin	Signal	Signal	Pin
1	GND	+3.3V	2
3	GND	+3.3V	4
5	NA	NA	6
7	NA	NA	8
9	GND	SATA_LED	10
11	NA	+3.3V	12
13	NA	+3.3V	14
15	GND	+3.3V	16
17	NA	+3.3V	18
19	NA	NA	20
21	GND	NA	22
23	NA	NA	24
25	NA	NA	26
27	GND	NA	28
29	NA	NA	30
31	NA	NA	32
33	GND	NA	34
35	NA	NA	36
37	NA	DEVSLP	38
39	GND	SMB_CLK	40
41	SATA-B+	SMB_DATA	42
43	SATA-B-	NA	44
45	GND	NA	46
47	SATA-A-	NA	48
49	SATA-A+	PERST#	50
51	GND	CLKREQ#	52
53	PEFCLK	WAKE#	54
55	PEFCLKp	NA	56
57	GND	NA	58
67	NA	NA	68
69	PEDET	+3.3V	70
71	GND	+3.3V	72
73	GND	+3.3V	74
75	GND		

### M.2 Key-E Socket (M2E\_1):

Key E (2230) with PCIe x1, CNVI and USB 2.0 for Wireless

Pin	Signal	Signal	Pin
1	GND	+3.3V	2
3	USB_D-	+3.3V	4
5	USB_D+	NA	6
7	GND	NA	8
9	CNV_WBR_D1-	CNV_RF_RESET	10
11	CNV_WBR_D1+	MODEN_CLKREQ	12
13	GND	MODEN_CLKREQ	14
15	CNV_WBR_D0-	NA	16
17	CNV_WBR_D0+	GND	18
19	GND	NA	20
21	CNV_WBR_CLK-	CNV_BRI_RSP	22
23	CNV_WBR_CLK+		
33	GND	CNV_BSI_DT	32
35	PETP	CNV_BRI_RSP	34
37	PETN	CNV_BRI_DT	36
39	GND	NA	38
41	PERP	NA	40
43	PERN	NA	42
45	GND	NA	44
47	PEFCLKp	NA	46
49	PEFCLK	NA	48
51	GND	SUSCLK	50
53	CLKREQ#	PERST#	52
55	WAKE#	W_DISABLE#	54
57	GND	W_DISABLE#	56
59	CNV_WT_D1-	SMB_DATA	58
61	CNV_WT_D1+	SMB_CLK	60
63	GND	NA	62
65	CNV_WT_OD-	CLKIN_VTAL_LCP	64
67	CNV_WT_D0+	NA	66
69	GND	NA	68
71	CNV_WT_CLK-	NA	70
73	CNV_WT_CLK+	+3.3V	72
75	GND	+3.3V	74

---

## 2.5 Jumpers Setup

The illustration shows how jumpers are setup. When the jumper cap is placed on pins, the jumper is “Short”. If no jumper cap is placed on pins, the jumper is “Open”. The illustration shows a 3-pin jumper whose pin1 and pin2 are “Short” when jumper cap is placed on these 2 pins.

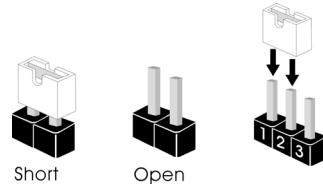

---

### Clear CMOS Jumper

(CLRMOS1)  
(see p.8, No. 31)



Note: CLRMOS1 allows you to clear the data in CMOS. To clear and reset the system parameters to default setup, please turn off the computer and unplug the power cord from the power supply. After waiting for 15 seconds, use a jumper cap to short pin2 and pin3 on CLRMOS1 for 5 seconds. However, please do not clear the CMOS right after you update the BIOS. If you need to clear the CMOS when you just finish updating the BIOS, you must boot up the system first, and then shut it down before you do the clear-CMOS action. Please be noted that the password, date, time, user default profile and MAC address will be cleared only if the CMOS battery is removed.

---

### Digital Input/Output Power Select

(3-pin JGPIO\_PWR1)  
(see p.8 No. 17)



1-2: +12V  
2-3: +5V

---

### ATX/AT Mode Select

(3-pin PWR\_JP1)  
(see p.8 No. 32)



1-2: AT Mode  
2-3: ATX Mode

---

### Panel Power Select (LCD\_VCC)

(5-pin PNL\_PWR1)  
(see p.8 No. 4)



Use this to set up the VDD power of the LVDS connector.  
1-2: +3V  
2-3: +5V  
3-4: +5V  
4-5: +12V

---

**Backlight Power Select**  
(LCD\_BLT\_VCC)

(3-pin BKT\_PWR1)  
(see p.8 No. 8)

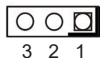

Use this to set up the backlight power of the LVDS connector.  
1-2: +5V  
2-3: +12V

---

**COM1 Pin9 PWR Setting Jumpers**

(3-pin PWR\_COM1: see p.8 No. 29)  
(3-pin PWR\_COM2: see p.8 No. 28)  
(3-pin PWR\_COM3: see p.8 No. 23)  
(3-pin PWR\_COM4: see p.8 No. 24)



1-2: +5V  
2-3: +12V



---

**GPIO Default Setting**

(3-pin JGPIO\_SET1)  
(see p.8 No. 16)



1-2: Pull-High  
2-3: Pull-Low

---

**BL1, BL2**

(2-pin BL1)  
(see p.8 No. 5)



Open : Protect LCD\_BLT\_VCC  
Short : No Protect LCD\_BLT\_VCC

(2-pin BL2)  
(see p.8 No. 9)



Open : Protect R\_LVDD  
Short : No Protect R\_LVDD

---

**Chassis Intrusion Headers**

(2-pin CI1, CI2: see p.8, No. 22)



This motherboard supports CASE OPEN detection feature that detects if the chassis cover has been removed. This feature requires a chassis with chassis intrusion detection design.  
CI1 :  
Close : Active Case Open  
Open : Normal  
CI2 :  
Close : Normal  
Open : Active Case Open

---

**SIO\_AT1**

(2-pin SIO\_AT1)  
(see p.8, No. 30)



Open : ATX Mode  
Short : AT Mode

---

## 2.6 Onboard Headers and Connectors



Onboard headers and connectors are NOT jumpers. Do NOT place jumper caps over these headers and connectors. Placing jumper caps over the headers and connectors will cause permanent damage of the motherboard!

---

### SATA3 Connector

(SATA3\_1: see p.8, No. 13)



SATA3\_1

These two Serial ATA3 (SATA3) connectors support SATA data cables for internal storage devices. The current SATA3 interface allows up to 6.0 Gb/s data transfer rate.

---

### USB 2.0 Header

(9-pin USB2\_5\_6)

(see p.8 No. 26)

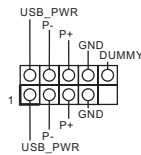

There is one USB 2.0 header on this motherboard.

---

### System Panel Header

(9-pin PANEL1)

(see p.8 No. 27)

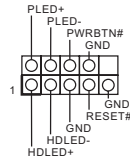

This header accommodates several system front panel functions.



Connect the power switch, reset switch and system status indicator on the chassis to this header according to the pin assignments below. Note the positive and negative pins before connecting the cables.

**PWRBTN (Power Switch):**

Connect to the power switch on the chassis front panel. You may configure the way to turn off your system using the power switch.

**RESET (Reset Switch):**

Connect to the reset switch on the chassis front panel. Press the reset switch to restart the computer if the computer freezes and fails to perform a normal restart.

**PLED (System Power LED):**

Connect to the power status indicator on the chassis front panel. The LED is on when the system is operating. The LED keeps blinking when the system is in S1 sleep state. The LED is off when the system is in S3/S4 sleep state or powered off (S5).



**HDLED (Hard Drive Activity LED):**

Connect to the hard drive activity LED on the chassis front panel. The LED is on when the hard drive is reading or writing data.

The front panel design may differ by chassis. A front panel module mainly consists of power switch, reset switch, power LED, hard drive activity LED, speaker and etc. When connecting your chassis front panel module to this header, make sure the wire assignments and the pin assignments are matched correctly.

**3W Audio AMP Output Wafer**

(4-pin SPEAKER1)

(see p.8 No. 2)



PIN	Signal Name
1	SPK L-
2	SPK L+
3	SPK R+
4	SPK R-

**CPU Fan Connector**

(4-pin CPU\_FAN1)

(see p.8 No. 11)

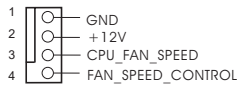

Please connect the CPU fan cable to the fan connector and match the black wire to the ground pin.



Though this motherboard provides 4-Pin CPU fan (Quiet Fan) support, the 3-Pin CPU fan still can work successfully even with the fan speed control function. If you plan to connect the 3-Pin CPU fan to the CPU fan connector on this motherboard, please connect it to Pin 1-3.

**ATX Power Connector**

(Input 9V-36V (Default); 12V only (by BOM option))

(4-pin ATX12V1)

(see p.8 No. 33)



Please connect a DC power supply to this connector.

1-4 : GND

2-3 : DC Input

**SATA Power Output Connector**

(4-pin SATA\_PWR1)

(see p.8 No. 15)

**Inverter Power Control Wafer**

(6-pin BLT\_PWR1)

(see p.8 No. 7)



PIN	Signal Name	PIN	Signal Name	PIN	Signal Name	PIN	Signal Name	PIN	Signal Name	PIN	Signal Name
6	LCD BLT_ VCC	5	LCD BLT_ VCC	4	CON LBKLT_ EN	3	CON LBKLT_ CTL	2	GND	1	GND

## COM Port Headers

(10-pin COM1)  
(see p.8 No. 19)

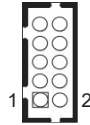

(10-pin COM2, 3, 4)  
(see p.8 No. 25)

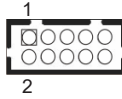

PIN	Signal Name	PIN	Signal Name	PIN	Signal Name	PIN	Signal Name	PIN	Signal Name
1	DDCD#	3	TTXD	5	GND	7	RRTS#	9	DUMMY
2	RRXD	4	DDTR#	6	DDSR#	8	CCTS#	10	DUMMY



This motherboard supports RS232/422/485 on COM1 port. Please refer to below table for the pin definition. In addition, COM1 port (RS232/422/485) can be adjusted in BIOS setup utility > Advanced Screen > Super IO Configuration. You may refer to page 31 for details.

### COM1 Port Pin Definition

PIN	RS232	RS422	RS485
1	DCD	TX-	RTX-
2	RXD	RX+	N/A
3	TXD	TX+	RTX+
4	DTR	RX-	N/A
5	GND	GND	GND
6	DSR	N/A	N/A
7	RTS	N/A	N/A
8	CTS	N/A	N/A
9	NA/+5V/+12V	N/A	N/A

## Buzzer Header

(2-pin BUZZ1)  
(see p.8 No. 3)



## Digital Input/Output Pin Header

(10-pin JGPIO1)  
(see p.8 No. 18)

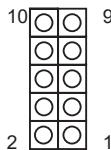

PIN	Signal Name	PIN	Signal Name
10	GND	9	JGPIO_PWR
8	SIO_GP83	7	SIO_GP87
6	SIO_GP82	5	SIO_GP86
4	SIO_GP81	3	SIO_GP85
2	SIO_GP80	1	SIO_GP84

## LVDS Connector

(40-pin LVDS1)

(see p.8 No. 6)

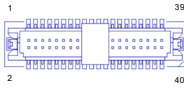

PIN	Signal Name	PIN	Signal Name
2	LCD_VCC	1	LCD_VCC
4	LDDC_CLK	3	+3.3V
6	LVDS_A_DATA0#	5	LDDC_DATA
8	GND	7	LVDS_A_DATA0
10	LVDS_A_DATA1	9	LVDS_A_DATA1#
12	LVDS_A_DATA2#	11	GND
14	GND	13	LVDS_A_DATA2
16	LVDS_A_DATA3	15	LVDS_A_DATA3#
18	LVDS_A_CLK#	17	GND
20	GND	19	LVDS_A_CLK
22	LVDS_B_DATA0	21	LVDS_B_DATA0#
24	LVDS_B_DATA1#	23	GND
26	GND	25	LVDS_B_DATA1
28	LVDS_B_DATA2	27	LVDS_B_DATA2#
30	LVDS_B_DATA3#	29	DPLVDD_EN
32	GND	31	LVDS_B_DATA3
34	LVDS_B_CLK	33	LVDS_B_CLK#
36	CON_LBKLT_EN	35	GND
38	LCD_BLT_VCC	37	CON_LBKLT_CTL
40	LCD_BLT_VCC	39	LCD_BLT_VCC

## Front Panel Audio Header

(9-pin HD\_AUDIO1)

(see p.8 No. 1)

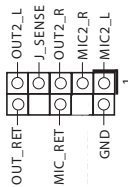

1. High Definition Audio supports Jack Sensing, but the panel wire on the chassis must support HDA to function correctly. Please follow the instruction in our manual and chassis manual to install your system.
2. If you use AC'97 audio panel, please install it to the front panel audio header as below:
  - A. Connect Mic\_IN (MIC) to MIC2\_L.
  - B. Connect Audio\_R (RIN) to OUT2\_R and Audio\_L (LIN) to OUT2\_L.
  - C. Connect Ground (GND) to Ground (GND).
  - D. MIC\_RET and OUT\_RET are for HD audio panel only. You don't need to connect them for AC'97 audio panel.
  - E. To activate the front mic.  
Go to the "FrontMic" Tab in the Realtek Control panel. Adjust "Recording Volume".

## Backlight & Amp Volume Control

(7-pin BLT\_VOL1)

(see p.8 No. 10)



PIN	Signal Name
7	GND
6	GND
5	GPIO_BLT_DW
4	GPIO_BLT_UP
3	PWRDN
2	GPIO_VOL_DW
1	GPIO_VOL_UP

---

## LPC Header

(18-pin LPC1)

(see p.8 No. 21)

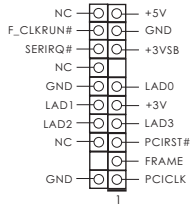

This connector supports Trusted Platform Module (TPM) system, which can securely store keys, digital certificates, passwords, and data. A TPM system also helps enhance network security, protects digital identities, and ensures platform integrity.

---

## USB 3.0 Header

(19-pin USB3\_5\_6)

(see p.8 No. 20)

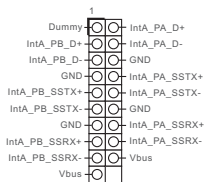

There is one USB 3.0 header on this motherboard.

---

# Chapter 3: UEFI SETUP UTILITY

## 3.1 Introduction

This section explains how to use the UEFI SETUP UTILITY to configure your system. The UEFI chip on the motherboard stores the UEFI SETUP UTILITY. You may run the UEFI SETUP UTILITY when you start up the computer. Please press <F2> or <Del> during the Power-On-Self-Test (POST) to enter the UEFI SETUP UTILITY, otherwise, POST will continue with its test routines.

If you wish to enter the UEFI SETUP UTILITY after POST, restart the system by pressing <Ctl> + <Alt> + <Delete>, or by pressing the reset button on the system chassis. You may also restart by turning the system off and then back on.



Because the UEFI software is constantly being updated, the following UEFI setup screens and descriptions are for reference purpose only, and they may not exactly match what you see on your screen.

### 3.1.1 UEFI Menu Bar

The top of the screen has a menu bar with the following selections:

<b>Main</b>	To set up the system time/date information
<b>Advanced</b>	To set up the advanced UEFI features
<b>H/W Monitor</b>	To display current hardware status
<b>Security</b>	To set up the security features
<b>Boot</b>	To set up the default system device to locate and load the Operating System
<b>Exit</b>	To exit the current screen or the UEFI SETUP UTILITY

Use <←> key or <→> key to choose among the selections on the menu bar, and then press <Enter> to get into the sub screen. You can also use the mouse to click your required item.

---

## 3.1.2 Navigation Keys

Please check the following table for the function description of each navigation key.

Navigation Key(s)	Function Description
← / →	Moves cursor left or right to select Screens
↑ / ↓	Moves cursor up or down to select items
+ / -	To change option for the selected items
<Enter>	To bring up the selected screen
<F1>	To display the General Help Screen
<F7>	Discard changes
<F9>	To load optimal default values for all the settings
<F10>	To save changes and exit the UEFI SETUP UTILITY
<F12>	Print screen
<ESC>	To jump to the Exit Screen or exit the current screen

## 3.2 Main Screen

When you enter the UEFI SETUP UTILITY, the Main screen will appear and display the system overview.

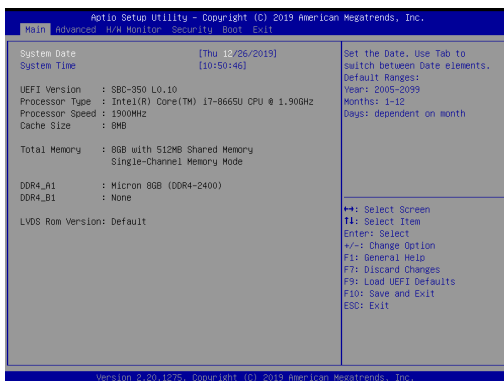

---

### 3.3 Advanced Screen

In this section, you may set the configurations for the following items: CPU Configuration, Chipset Configuration, Storage Configuration, Super IO Configuration, AMT Configuration, ACPI Configuration, USB Configuration and Trusted Computing.

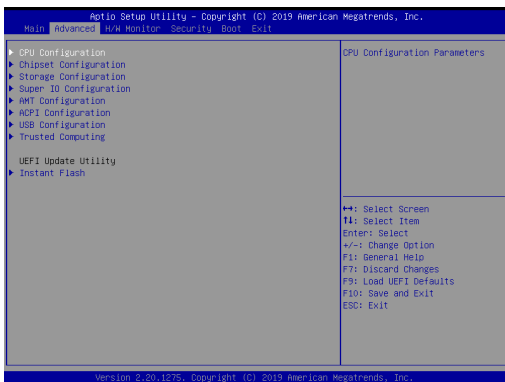

Setting wrong values in this section may cause the system to malfunction.

#### Instant Flash

Instant Flash is a UEFI flash utility embedded in Flash ROM. This convenient UEFI update tool allows you to update system UEFI without entering operating systems first like MS-DOS or Windows®. Just launch this tool and save the new UEFI file to your USB flash drive, floppy disk or hard drive, then you can update your UEFI only in a few clicks without preparing an additional floppy diskette or other complicated flash utility. Please be noted that the USB flash drive or hard drive must use FAT32/16/12 file system. If you execute Instant Flash utility, the utility will show the UEFI files and their respective information. Select the proper UEFI file to update your UEFI, and reboot your system after UEFI update process completes.

---

### 3.3.1 CPU Configuration



#### Intel Hyper-Threading Technology

To enable this feature, a computer system with an Intel processor that supports Hyper-Threading technology and an operating system that includes optimization for this technology, such as Microsoft® Windows® 7 / 8 / 8.1 / 10 is required. Set to [Enabled] if using Microsoft® Windows® 7, 8, 8.1, 10 or Linux kernel version 2.4.18 or higher. This option will be hidden if the installed CPU does not support Hyper-Threading technology.

#### Active Processor Cores

Select the number of cores to enable in each processor package.

#### CPU C States Support

Enable CPU C States Support for power saving. It is recommended to keep C3, C6 and C7 all enabled for better power saving.

#### Intel Virtualization Technology

When this option is set to [Enabled], a VMM (Virtual Machine Architecture) can utilize the additional hardware capabilities provided by Vanderpool Technology. This option will be hidden if the installed CPU does not support Intel Virtualization Technology.

#### Intel SpeedStep Technology

Intel SpeedStep technology is Intel's new power saving technology. Processors can switch between multiple frequencies and voltage points to enable power saving. The default value is [Enabled]. Configuration options: [Enabled] and [Disabled]. If you install Windows® 7 / 8 / 8.1 / 10 and want to enable this function, please set this item to [Enabled]. This item will be hidden if the current CPU does not support Intel SpeedStep technology.



Please note that enabling this function may reduce CPU voltage and lead to system stability or compatibility issues with some power supplies. Please set this item to [Disabled] if above issues occur.



---

### **Intel Turbo Boost Technology**

Use this item to enable or disable Intel Turbo Boost Mode Technology. Turbo Boost Mode allows processor cores to run faster than marked frequency in specific conditions. The default value is [Enabled].

### **CPU Thermal Throttling**

You may select [Enabled] to enable CPU internal thermal control mechanism to keep the CPU from overheating.

---

## 3.3.2 Chipset Configuration

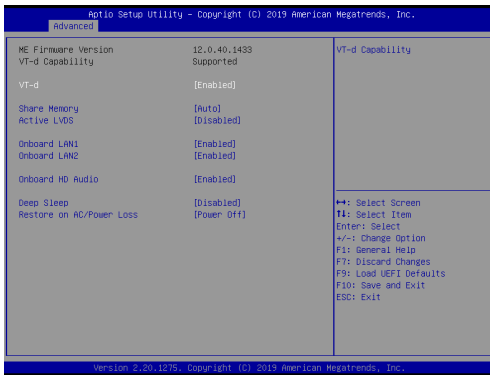

### VT-d

Use this to enable or disable Intel® VT-d technology (Intel® Virtualization Technology for Directed I/O). The default value of this feature is [Disabled].

### Share Memory

Configure the size of memory that is allocated to the integrated graphics processor when the system boots up.

### Active LVDS

Use this to enable or disable the LVDS. The default value is [Disabled]. Set the item to [enable]. Then press <F10> to save the setting and restart the system. Now the default value of Active LVDS is changed to ENABLE (F9 load default is also set to ENABLE)

Change the setting from [Enable] to [Disable], and then press <F10> to save the setting and restart the system. Likewise, the default value of Active LVDS is changed to DISABLE (F9 load default is also set to DISABLE)

### Panel Type Selection

Use this to select panel type. This item appears when you enable Active LVDS.



The default values of Active LVDS and Panel Type Selection will be changed only when the users manually adjust them. They will keep at the default values no matter you clear CMOS, use Instant Flash or press <F9>.

### Onboard LAN1

This allows you to enable or disable the Onboard LAN1 feature.

### Onboard LAN2

This allows you to enable or disable the Onboard LAN2 feature.

---

**Onboard HD Audio**

Select [Auto], [Enabled] or [Disabled] for the onboard HD Audio feature. If you select [Auto], the onboard HD Audio will be disabled when PCI Sound Card is plugged.

**Deep Sleep**

Mobile platforms support Deep S4/S5 in DC only and desktop platforms support Deep S4/S5 in AC only. The default value is [Disabled].

**Restore on AC/Power Loss**

Select the power state after a power failure. If [Power Off] is selected, the power will remain off when the power recovers. If [Power On] is selected, the system will start to boot up when the power recovers.

---

### 3.3.3 Storage Configuration

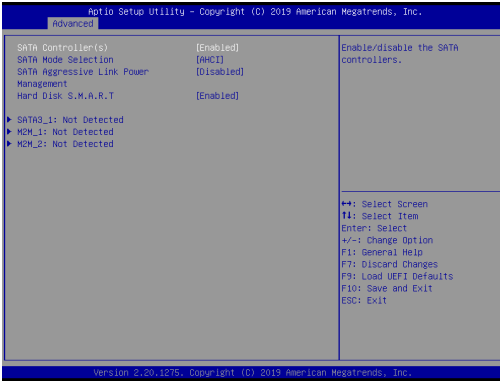

#### SATA Controller(s)

Use this item to enable or disable the SATA Controller feature.

#### SATA Mode Selection

Use this to select SATA mode. The default value is [AHCI Mode].



AHCI (Advanced Host Controller Interface) supports NCQ and other new features that will improve SATA disk performance but IDE mode does not have these advantages.

#### SATA Aggressive Link Power Management

Use this item to configure SATA Aggressive Link Power Management.

#### Hard Disk S.M.A.R.T.

Use this item to enable or disable the S.M.A.R.T. (Self-Monitoring, Analysis, and Reporting Technology) feature. Configuration options: [Disabled] and [Enabled].

---

## 3.3.4 Super IO Configuration



### COM1 Configuration

Use this to set parameters of COM1.

#### Type Select

Use this to select COM1 port type: [RS232], [RS422] or [RS485].

### COM2 Configuration

Use this to set parameters of COM2.

### COM3 Configuration

Use this to set parameters of COM3.

### COM4 Configuration

Use this to set parameters of COM4.

### WDT Timeout Reset

Use this to set the Watch Dog Timer.

---

### 3.3.5 AMT Technology

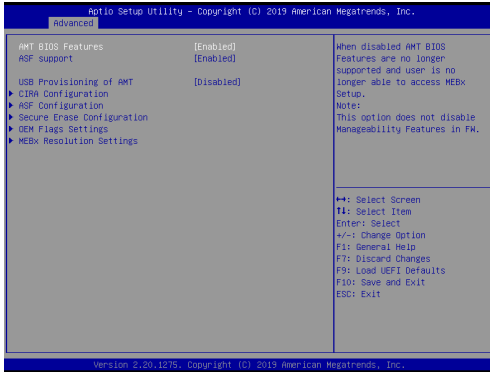

#### Intel AMT

Use this to enable or disable Intel(R) Active Management Technology BIOS Extension. The default is [Enabled].

#### BIOS Hotkey Pressed

Use this to enable or disable BIOS hotkey press. The default is [Disabled].

#### MEBx Selection Screen

Use this to enable or disable MEBx Selection Screen. The default is [Disabled].

#### Hide Un-Configure ME Confirmation

Hide Un-Configure ME without password confirmation prompt. The default is [Disabled].

#### MEBx Debug Message Output

Use this to enable or disable MEBx Debug Message Output. The default is [Disabled].

#### Un-Configure ME

Un-Configure ME without password. The default is [Disabled].

#### Amt Wait Timer

Set timer to wait before sending ASF\_GET\_BOOT\_OPTIONS.

#### ASF

Use this to enable or disable Alert Specification Format. The default is [Enabled].

#### Activate Remote Assistance Process

Trigger CIRA boot. The default is [Disabled].

#### USB Configure

Use this to enable or disable USB Configure function. The default is [Enabled].

---

**PET Progress**

User can enable or disable PET Events progress to receive PET events or not. The default is [Enabled].

---

### 3.3.6 ACPI Configuration

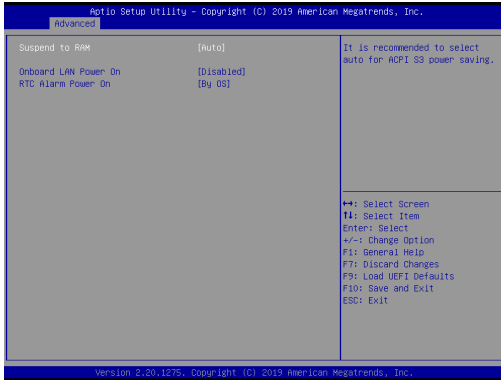

#### Suspend to RAM

Use this item to select whether to auto-detect or disable the Suspend-to-RAM feature. Select [Auto] will enable this feature if the OS supports it.

#### Onboard LAN Power On

Use this item to enable or disable onboard LAN to turn on the system from the power-soft-off mode.

#### RTC Alarm Power On

Use this item to enable or disable RTC (Real Time Clock) to power on the system.



---

### 3.3.7 USB Configuration

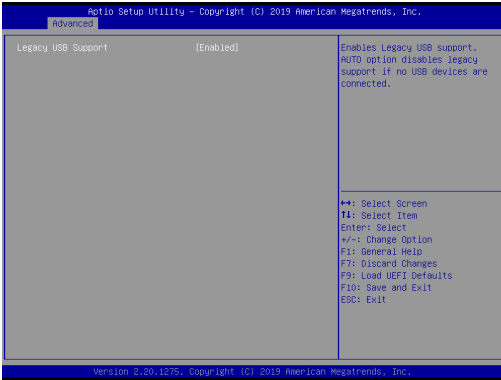

#### Legacy USB Support

Use this option to select legacy support for USB devices. There are two configuration options: [Enabled] and [UEFI Setup Only]. The default value is [Enabled]. Please refer to below descriptions for the details of these two options:

[Enabled] - Enables support for legacy USB.

[UEFI Setup Only] - USB devices are allowed to use only under UEFI setup and Windows / Linux OS.

---

### 3.3.8 Trusted Computing

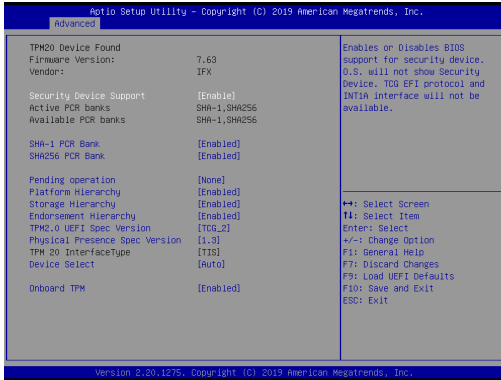

#### Security Device Support

Enable or disable BIOS support for security device.

---

### 3.4 Hardware Health Event Monitoring Screen

In this section, it allows you to monitor the status of the hardware on your system, including the parameters of the CPU temperature, motherboard temperature, CPU fan speed, chassis fan speed, and the critical voltage.

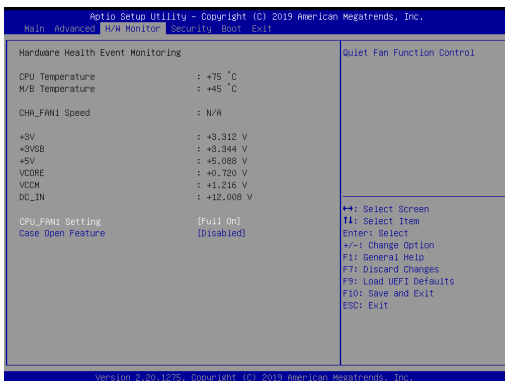

#### CPU\_FAN1 Setting

This allows you to set CPU fan 1's speed. Configuration options: [Full On] and [Automatic Mode]. The default value is [Full On].

#### Case Open Feature

This allows you to enable or disable case open detection feature. The default is value [Disabled].

#### Clear Status

This option appears only when the case open has been detected. Use this option to keep or clear the record of previous chassis intrusion status.

---

## 3.5 Security Screen

In this section, you may set, change or clear the supervisor/user password for the system.

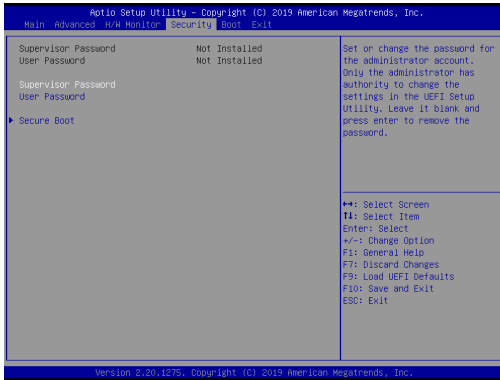

### Supervisor Password

Set or change the password for the administrator account. Only the administrator has authority to change the settings in the UEFI Setup Utility. Leave it blank and press enter to remove the password.

### User Password

Set or change the password for the user account. Users are unable to change the settings in the UEFI Setup Utility. Leave it blank and press enter to remove the password.

### Secure Boot

Enable to support Windows 8.1 / 8 Secure Boot.

---

## 3.6 Boot Screen

In this section, it will display the available devices on your system for you to configure the boot settings and the boot priority.

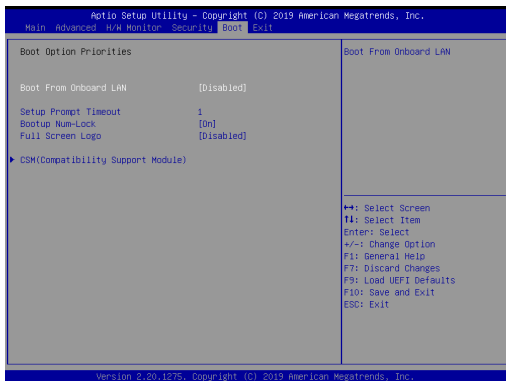

### Boot From Onboard LAN

Use this item to enable or disable the Boot From Onboard LAN feature.

### Setup Prompt Timeout

This shows the number of seconds to wait for setup activation key. 65535(0xFFFF) means indefinite waiting.

### Bootup Num-Lock

If this item is set to [On], it will automatically activate the Numeric Lock function after boot-up.

### Full Screen Logo

Use this item to enable or disable OEM Logo. The default value is [Enabled].

---

## CSM (Compatibility Support Module)



### CSM

Enable to launch the Compatibility Support Module. Please do not disable unless you're running a WHCK test. If you are using Windows® 8.1 / 8 64-bit and all of your devices support UEFI, you may also disable CSM for faster boot speed.

### Launch PXE OpROM Policy

Select UEFI only to run those that support UEFI option ROM only. Select Legacy only to run those that support legacy option ROM only. Select Do not launch to not execute both legacy and UEFI option ROM.

### Launch Storage OpROM Policy

Select UEFI only to run those that support UEFI option ROM only. Select Legacy only to run those that support legacy option ROM only. Select Do not launch to not execute both legacy and UEFI option ROM.

### Launch Video OpROM Policy

Select UEFI only to run those that support UEFI option ROM only. Select Legacy only to run those that support legacy option ROM only. Select Do not launch to not execute both legacy and UEFI option ROM.

---

## 3.7 Exit Screen

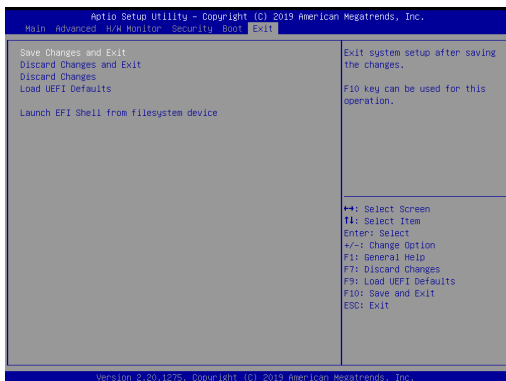

### Save Changes and Exit

When you select this option, it will pop-out the following message, "Save configuration changes and exit setup?" Select [OK] to save the changes and exit the UEFI SETUP UTILITY.

### Discard Changes and Exit

When you select this option, it will pop-out the following message, "Discard changes and exit setup?" Select [OK] to exit the UEFI SETUP UTILITY without saving any changes.

### Discard Changes

When you select this option, it will pop-out the following message, "Discard changes?" Select [OK] to discard all changes.

### Load UEFI Defaults

Load UEFI default values for all the setup questions. F9 key can be used for this operation.

### Launch EFI Shell from filesystem device

Attempts to Launch EFI Shell application (Shell64.efi) from one of the available filesystem devices.

---

## **Chapter 4: Software Support**

### **4.1 Install Operating System**

This motherboard supports various Microsoft® Windows® operating systems: 10 / 10 64-bit / 8.1 / 8.1 64-bit / 8 / 8 64-bit / 7 / 7 64-bit. Because motherboard settings and hardware options vary, use the setup procedures in this chapter for general reference only. Refer your OS documentation for more information.

### **4.2 Support CD Information**

The Support CD that came with the motherboard contains necessary drivers and useful utilities that enhance the motherboard's features.

#### **4.2.1 Running The Support CD**

To begin using the support CD, insert the CD into your CD-ROM drive. The CD automatically displays the Main Menu if "AUTORUN" is enabled in your computer. If the Main Menu did not appear automatically, locate and double click on the file "ASRSETUP.EXE" from the BIN folder in the Support CD to display the menus.

#### **4.2.2 Drivers Menu**

The Drivers Menu shows the available device's drivers if the system detects installed devices. Please install the necessary drivers to activate the devices.

#### **4.2.3 Utilities Menu**

The Utilities Menu shows the application software that the motherboard supports. Click on a specific item then follow the installation wizard to install it.

#### **4.2.4 Contact Information**

If you need to contact ASRockInd or want to know more about ASRockInd, you're welcome to visit ASRockInd's website at <http://www.asrockind.com>; or you may contact your dealer for further information.