

4X4 BOX 8040 Series

Version 1.0

Published March, 2024

Copyright©2024 ASRockInd INC. All rights reserved.

Copyright Notice:

No part of this documentation may be reproduced, transcribed, transmitted, or translated in any language, in any form or by any means, except duplication of documentation by the purchaser for backup purpose, without written consent of ASRockInd Inc.

Products and corporate names appearing in this documentation may or may not be registered trademarks or copyrights of their respective companies, and are used only for identification or explanation and to the owners' benefit, without intent to infringe.

Disclaimer:

Specifications and information contained in this documentation are furnished for informational use only and subject to change without notice, and should not be constructed as a commitment by ASRockInd. ASRockInd assumes no responsibility for any errors or omissions that may appear in this documentation.

With respect to the contents of this documentation, ASRockInd does not provide warranty of any kind, either expressed or implied, including but not limited to the implied warranties or conditions of merchantability or fitness for a particular purpose.

In no event shall ASRockInd, its directors, officers, employees, or agents be liable for any indirect, special, incidental, or consequential damages (including damages for loss of profits, loss of business, loss of data, interruption of business and the like), even if ASRockInd has been advised of the possibility of such damages arising from any defect or error in the documentation or product.



This device complies with Part 15 of the FCC Rules. Operation is subject to the following two conditions:

- (1) this device may not cause harmful interference, and
- (2) this device must accept any interference received, including interference that may cause undesired operation.

The terms HDMI® and HDMI High-Definition Multimedia Interface, and the HDMI logo are trademarks or registered trademarks of HDMI Licensing LLC in the United States and other countries.





WARNING

THIS PRODUCT CONTAINS A BUTTON BATTERY
If swallowed, a button battery can cause serious injury or death.
Please keep batteries out of sight or reach of children.

Replaceable batteries



CAUTION

**RISK OF EXPLOSION IF BATTERY IS REPLACED BY AN INCORRECT TYPE.
DISPOSE OF USED BATTERIES ACCORDING TO THE INSTRUCTIONS**

This product is intended to be supplied by a Listed Power Adapter or DC power source marked "L.P.S." (or "Limited Power Source"), rated 19 Vdc, 6.32 A minimum, Tma = 40 degree C minimum.

All interior servicing is to be performed by qualified skilled personnel only.

Button Battery Safety Notice

 WARNING	
<ul style="list-style-type: none">• INGESTION HAZARD: This product contains a button cell or coin battery.• DEATH or serious injury can occur if ingested.• A swallowed button cell or coin battery can cause Internal Chemical Burns in as little as 2 hours.• KEEP new and used batteries OUT OF REACH of CHILDREN• Seek immediate medical attention if a battery is suspected to be swallowed or inserted inside any part of the body.	

- Remove and immediately recycle or dispose of used batteries according to local regulations and keep away from children. Do NOT dispose of batteries in household trash or incinerate.
- Even used batteries may cause severe injury or death.
- Call a local poison control center for treatment information.
- Battery type: CR2032
- Battery voltage: 3.3V
- Non-rechargeable batteries are not to be recharged.
- Do not force discharge, recharge, disassemble, heat above (manufacturer's specified temperature rating) or incinerate. Doing so may result in injury due to venting, leakage or explosion resulting in chemical burns.
- This product contains an irreplaceable battery.
- This icon indicates that a swallowed button battery can cause serious injury or death. Please keep batteries out of sight or reach of children.

CALIFORNIA, USA ONLY

The Lithium battery adopted on this motherboard contains Perchlorate, a toxic substance controlled in Perchlorate Best Management Practices (BMP) regulations passed by the California Legislature. When you discard the Lithium battery in California, USA, please follow the related regulations in advance.

“Perchlorate Material-special handling may apply, see www.dtsc.ca.gov/hazardouswaste/perchlorate”

AUSTRALIA ONLY

Our goods come with guarantees that cannot be excluded under the Australian Consumer Law. You are entitled to a replacement or refund for a major failure and compensation for any other reasonably foreseeable loss or damage caused by our goods. You are also entitled to have the goods repaired or replaced if the goods fail to be of acceptable quality and the failure does not amount to a major failure. If you require assistance please call ASRockInd Tel : +886-2-28965588 ext.123 (Standard International call charges apply)



ASRockInd follows the green design concept to design and manufacture our products, and makes sure that each stage of the product life cycle of ASRockInd product is in line with global environmental regulations. In addition, ASRockInd disclose the relevant information based on regulation requirements.



DO NOT throw the motherboard in municipal waste. This product has been designed to enable proper reuse of parts and recycling. This symbol of the crossed out wheeled bin indicates that the product (electrical and electronic equipment) should not be placed in municipal waste. Check local regulations for disposal of electronic products.



CAUTION (or Warning)

Hot surface
Do not touch

The equipment intended only for use in a Restricted Access Area.

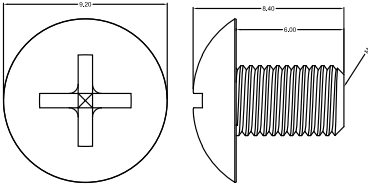

VESA Mount: M4x6mm Screws *(for securing the VESA bracket to the monitor)*

This product should be connected by means of a power cord to a socket-outlet with earthing connection.

Be sure to turn off the power and then disconnect the power cords from your system before performing any installation or servicing. A sudden surge of power could damage sensitive electronic components.

Contents

Chapter 1 Introduction	1
1.1 Package Contents	1
1.2 Product Specifications	2
1.3 Block Diagram	4
Chapter 2 Product Overview	5
2.1 Front View	5
2.2 Rear View	6
2.3 Inside View	8
Chapter 3 Hardware Installation	9
3.1 How to Remove the Bottom Case	9
3.2 How to Install the WiFi Module	10
3.3 How to install the M.2 SSD (Type 2280)	11
3.4 How to install the M.2 SSD (Type 2242)	12
3.5 How to Install the Memory Modules (DDR5)	13
3.6 How to Install the VESA Bracket	14
3.7 Position	15
Chapter 4 Motherboard	16
4.1 Motherboard Layout	16
4.2 Onboard Headers and Connectors	18
4.3 Expansion Slots (M.2 Slots)	20
Chapter 5 UEFI Setup Utility	21
5.1 Introduction	21
5.1.1 Entering BIOS Setup	21

5.1.2	UEFI Menu Bar	22
5.1.3	Navigation Keys	23
5.3	Advanced Screen	25
5.3.1	CPU Configuration	26
5.3.2	Chipset Configuration	27
5.3.3	Super IO Configuration	29
5.3.4	ACPI Configuration	30
5.3.5	USB Configuration	31
5.3.6	Power Configuration	32
5.3.7	Trusted Computing	33
5.4	Hardware Health Event Monitoring Screen	35
5.5	Security Screen	36
5.6	Boot Screen	37
5.7	Exit Screen	38
	Chapter 6 Software Support	39
6.1	Install Operating System	39

Chapter 1 Introduction



Because the hardware specifications might be updated, the content of this documentation will be subject to change without notice.

1.1 Package Contents

- 1 x 4X4 BOX 8040 Series
- 1 x M.2 Screw
- 1 x 19V/120W Power Adapter (Ryzen 7)
- 1 x 19V/90W Power Adapter (Ryzen 5)
- 1 x VESA Mount Bracket & Screw Package
- 1 x Quick Installation Guide
- 1 x Power Cord (by request)



*The barebone system does not include memory, hard drive and M.2 SSD.
If any items are missing or appear damaged, contact your authorized dealer.*

1.2 Product Specifications

4X4 BOX 8040U Series	Barebone
CPU	AMD Ryzen™ 8040U-Series - 4X4 BOX-8840U (AMD Ryzen™ 7 8840U, 8 Cores, Max Speed up to 5.1GHz) - 4X4 BOX-8640U (AMD Ryzen™ 5 8640U, 6 Cores, Max Speed up to 4.9GHz)
BIOS	AMI SPI 256 Mbit
Memory	Supports Dual Channel DDR5 5600 MHz, 2 x 262-pin SO-DIMM slots, 96GB (48 GB per DIMM)
Storage	1 x M.2 (KEY M, 2242/2280) with PCIe Gen4 x4 for SSD 1 x M.2 (KEY M, 2242) with PCIe Gen4 x4 for SSD
LAN	LAN1: Realtek RTL8125BG with 10/100/1000/2500 Mbps LAN2: Realtek RTL8111H with 10/100/1000 Mbps,
WiFi	1 x Wi-Fi 6E 802.11ax + BT 5.2
Audio	Realtek ALC256, High Definition Audio
Front I/O	1 x USB 3.2 Gen2 (Type-A), 2 x USB4 (Supports DP1.4a display output), 1 (headphone & microphone jack)
Rear I/O	2 x HDMI 2.1, 1 x 1 Gigabit LAN, 1 x 2.5 Gigabit LAN, 2 x USB 2.0, 1 x DC Jack
Power Unit	1 x 19V/120W Power Adapter (Ryzen 7) 1 x 19V/90W Power Adapter (Ryzen 5)

**Dimensions
(L x W x H)**

117.5 x 110.0 x 49mm (4.63" x 4.33" x 1.93")

VESA

Bracket included , supports 75 x 75 and 100 x 100 mm

Weight

1kg

**Operating
Temperature**

0°C ~ 40°C

1.3 Block Diagram

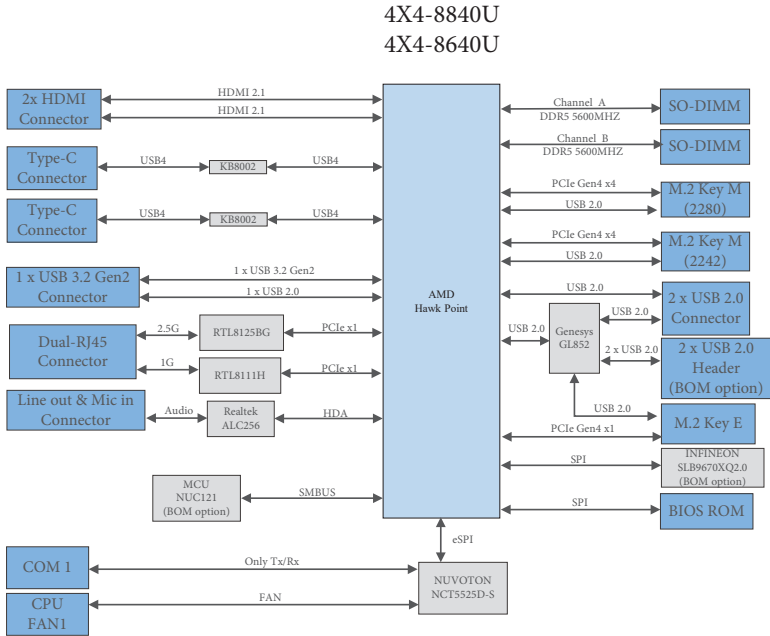

Chapter 2 Product Overview

This chapter provides diagrams showing the location of important components of the 4X4 BOX 8040 Series.

2.1 Front View

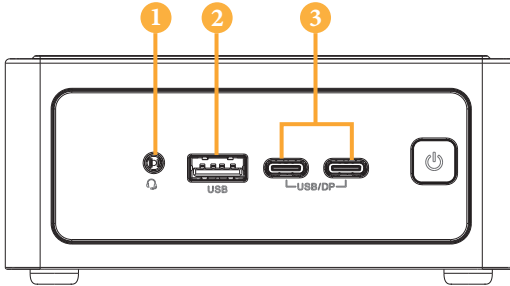

No.	Description
1	Audio (headphone, microphone)
2	USB 3.2 Gen2 (Type-A)
3	USB4 (Type-C, supports DP 1.4a display output)

2.2 Rear View

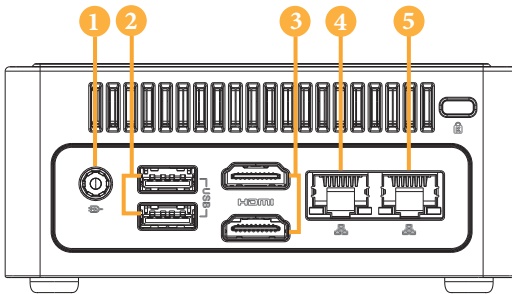

No.	Description
1	DC-IN
2	2 x USB 2.0 (Type-A)
3	2 x HDMI 2.1*
4	LAN1: RJ-45 (1G)**
5	LAN2: RJ-45 (2.5G)***

* To use DisplayPort as a display output, please connect your monitor/display to HDMI Port when installing OS system.

This DisplayPort only supports DP to HDMI dongle and DP to DVI dongle, and does not support DP to D-Sub dongle.

** There are two LEDs on the LAN1 port. Please refer to the table below for the LAN1 port LED indications.

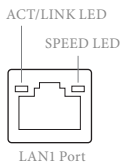

Activity / Link LED		Speed LED	
Status	Description	Status	Description
Off	No Link	Off	10Mbps connection
Blinking	Data Activity	Orange	100Mbps connection
On	Link	Green	1Gbps connection

*** There are two LEDs on the LAN2 port. Please refer to the table below for the LAN2 port LED indications.

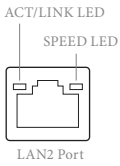

Activity / Link LED		Speed LED	
Status	Description	Status	Description
Off	No Link	Off	10Mbps connection
Blinking	Data Activity	Orange	100Mbps/1Gbps connection
On	Link	Green	2.5Gbps connection

2.3 Inside View

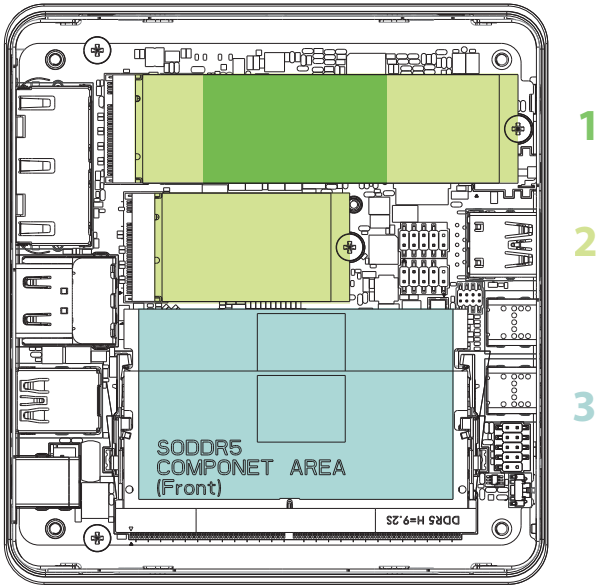

No.	Description
1	WiFi Module Slot
2	M.2 SSD slots (2242/2280)
3	SO-DIMM Slots



SO-DIMM memory, Wifi module and M.2 are not included with this system.

Chapter 3 Hardware Installation

This chapter helps you install or remove important components.

3.1 How to Remove the Bottom Case

1. Remove the four screws on the bottom case.
2. Then lift up and remove the bottom panel.

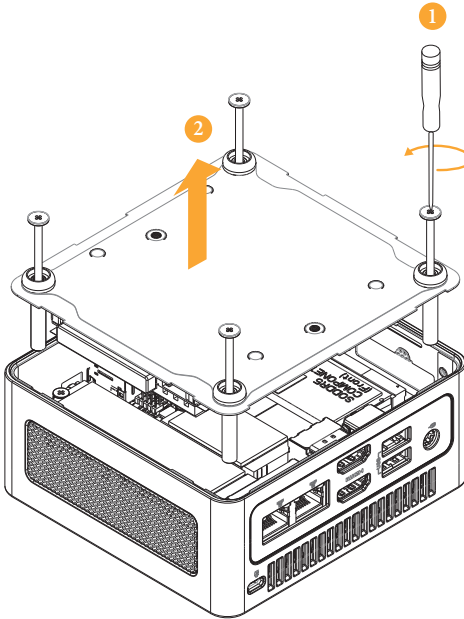

3.2 How to Install the WiFi Module

1. Locate the WiFi Module slot on the motherboard.

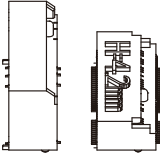

2. Carefully insert the WiFi Module into the slot at a 30-degree angle.

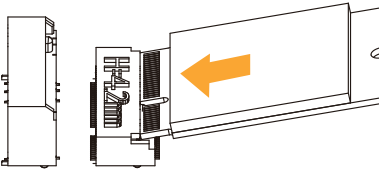

3. Tighten the screw to secure the WiFi Module to the motherboard.

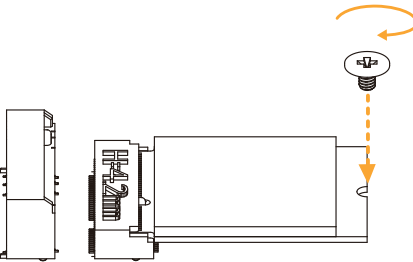

3.3 How to install the M.2 SSD (Type 2280)

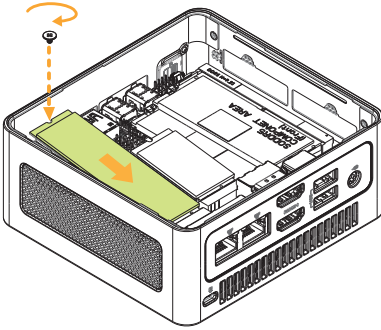

1. Locate the M.2 slot on the motherboard

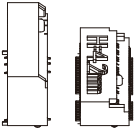

2. Carefully insert the M.2 SSD (Type 2280) into the slot at a 30-degree angle.

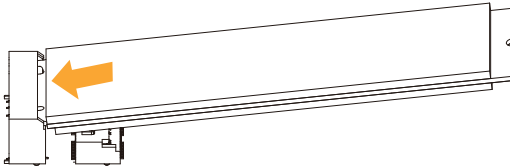

3. Tighten the screw to secure the M.2 SSD (Type 2280) to the motherboard.

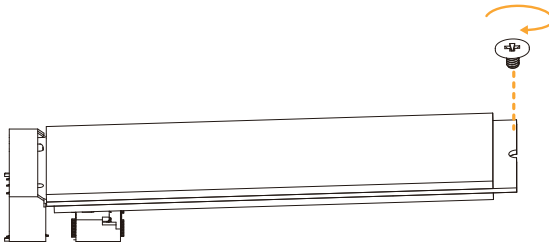

3.4 How to install the M.2 SSD (Type 2242)

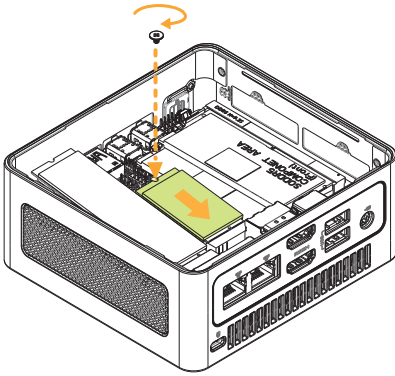

1. Locate the M.2 slot on the motherboard..

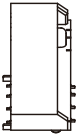

2. Carefully insert the M.2 SSD (Type 2242) into the the slot at a 30-degree angle.



3. Tighten the screw to secure the M.2 SSD (Type 2242) to the motherboard.

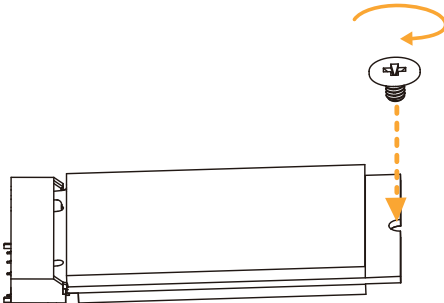

3.5 How to Install the Memory Modules (DDR5)



1. The 4X4 BOX 8040 Series requires DDR5 SO-DIMM.
2. For dual channel configuration, you always need to install identical (the same brand, speed, size and chip-type) DDR5 SO-DIMM pairs.



The SO-DIMM only fits in one correct orientation. It will cause permanent damage to the motherboard and the DIMM if you force the DIMM into the slot at incorrect orientation.

1. Carefully insert the SO-DIMM memory modules into the slot at a 30-degree angle.

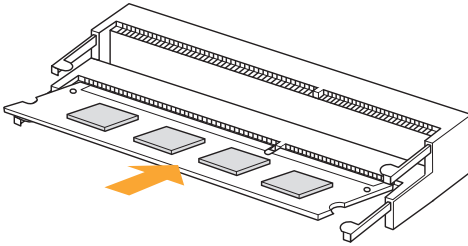

2. Push down until the modules snap into place.

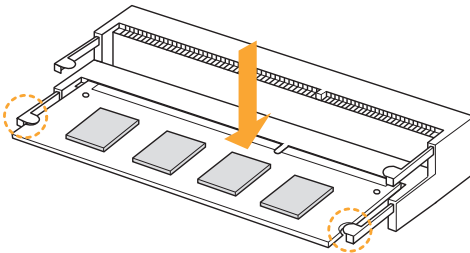

3.6 How to Install the VESA Bracket

1. Attach the two screws to the base of the 4X4 BOX 8040 Series.

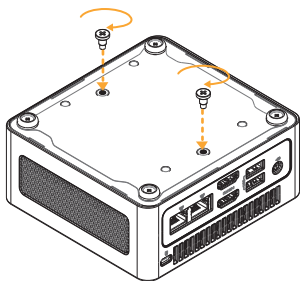

2. Attach the VESA Bracket to the rear of a compatible display using the four screws.
*Choose mounting holes depending on the mounting hole pattern of your LCD screen (75 mm × 75 mm or 100 mm × 100 mm).

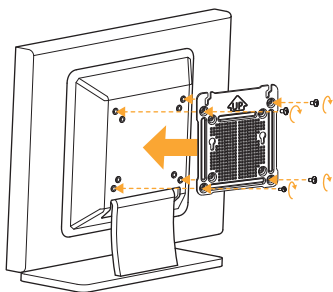

3. Mount the 4X4 BOX 8040 Series by sliding it into place.

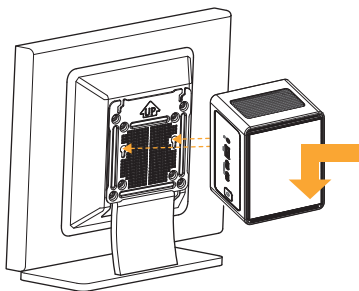

3.7 Position

The 4X4 BOX-8040 Series can be placed in vertical or horizontal position.

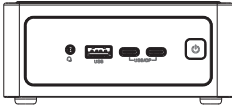

Horizontal Position

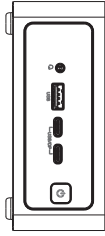

Vertical Position

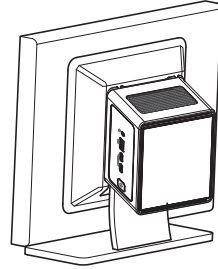

VESA-mounted



Please note that keeping the 4X4 BOX-8040 Series in a vertical position will ensure better cooling performance.

Chapter 4 Motherboard

4.1 Motherboard Layout

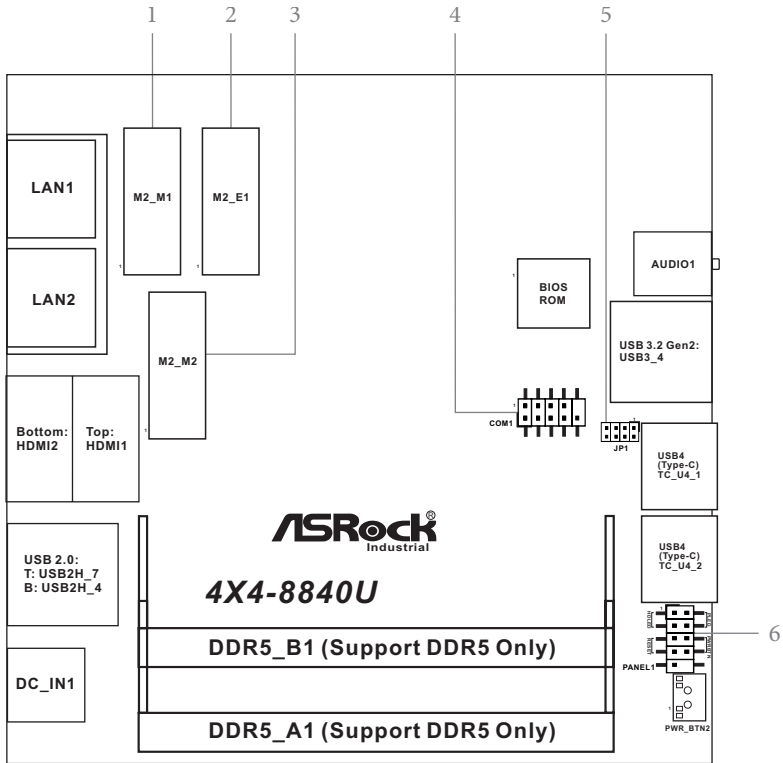

- 1 : M.2 Key-M Socket (M2_M1)
- 2 : M.2 Key-E Socket (M2_E1)
- 3 : M.2 Key-M Socket (M2_M2)
- 4 : COM Port Header (COM1)
- 5 : JP1 Header (JP1)
- 6 : System Panel Header (PANEL1)

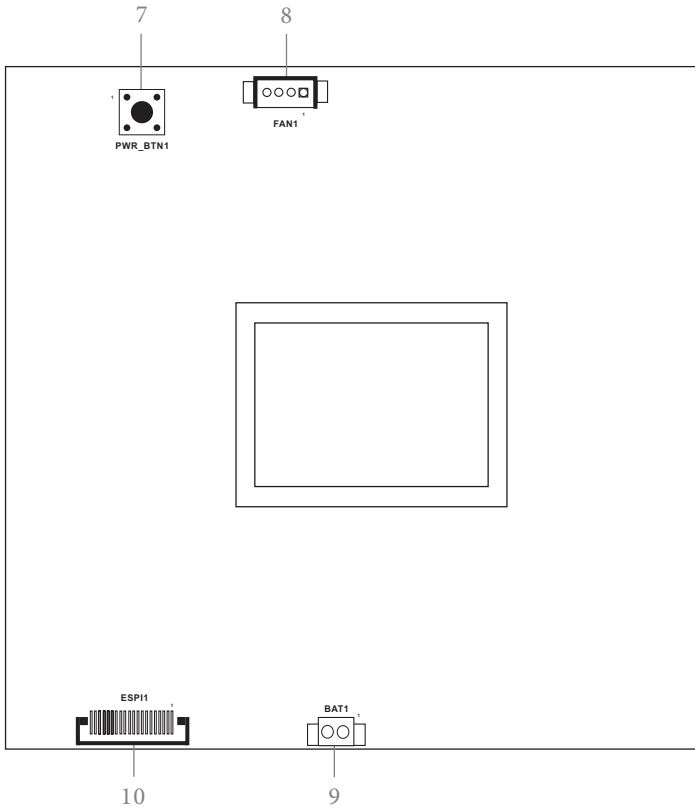

Backside :

7 : Power Button (PWR_BTN1)

8 : Fan Connector (FAN1)

9 : Battery Connector (BAT1)

10 : ESPI Connector (ESPI1)

4.2 Onboard Headers and Connectors



Onboard headers and connectors are **NOT** jumpers. Do **NOT** place jumper caps over these headers and connectors. Placing jumper caps over the headers and connectors will cause permanent damage to the motherboard!

COM Port Header

(9-pin COM1)

(see p. 16, No. 4)

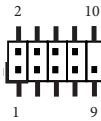

Pin	Signal Name	Signal Name	Pin
1	N/A	RRXD1	2
3	TTXD1	N/A	4
5	GND	N/A	6
7	N/A	N/A	8
9	PWR		10

JP1 Header

(8-pin JP1)

(see p. 16, No. 5)

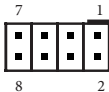

Pin	Signal Name
JP1_12	SIO AT Mode
JP1_34	CMOS Normal (Default)
JP1_46	Clear CMOS
JP1_57	Reserved for AT mode

System Panel Header

(10-pin PANEL1)

(see p. 16, No. 6)

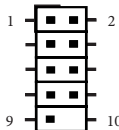

Pin	Signal Name	Signal Name	Pin
1	HDLED+	PLED+	2
3	HDLED-	PLED-	4
5	GND	PWRBTN#	6
7	RESET#	GND	8
9	DUMMY		10



Connect the power switch, reset switch and system status indicator on the chassis to this header according to the pin assignments below. Note the positive and negative pins before connecting the cables.

PWRBTN (Power Switch):

Connect to the power switch on the chassis front panel. You may configure the way to turn off your system using the power switch.

RESET (Reset Switch):

Connect to the reset switch on the chassis front panel. Press the reset switch to restart the computer if the computer freezes and fails to perform a normal restart.

PLED (System Power LED):

Connect to the power status indicator on the chassis front panel. The LED is on when the system is operating. The LED keeps blinking when the system is in S3 sleep state. The LED is off when the system is in S4 sleep state or powered off (S5).

HDLED (Hard Drive Activity LED):

Connect to the hard drive activity LED on the chassis front panel. The LED is on when the hard drive is reading or writing data.

The front panel design may differ by chassis. A front panel module mainly consists of power switch, reset switch, power LED, hard drive activity LED, speaker and etc. When connecting your chassis front panel module to this header, make sure the wire assignments and the pin assignments are matched correctly.

Backside :

Power Button

(PWR_BTN1)
(see p. 17, No. 7)



FAN Connector

(4-pin FAN1)
(see p. 17, No. 8)

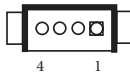

Pin	Signal Name
1	GND
2	+5V
3	FAN_SPEED
4	FAN_SPEED_CONTROL

Battery Connector

(BAT1)
(see p. 17, No. 9)



Pin	Signal Name
1	+BAT
2	GND

ESPI Connector

(20-pin ESPI1)
(see p. 17, No. 10)



Pin	Signal Name
1	GND
2	ESPI_CLK
3	GND
4	ESPI_CS1#
5	ESPI_RESET#
6	GND
7	+3V
8	GND
9	SMB_CLK_MAIN_3V
10	SMB_DATA_MAIN_3V
11	ESPI_DAT0
12	ESPI_DAT1
13	ESPI_DAT2
14	ESPI_DAT3
15	GND
16	+3VSB
17	GPIO_TEST#
18	GND
19	ESPI_ALERT#
20	GND

The header is reserved for Port 80 code display and debugging purposes.

4.3 Expansion Slots (M.2 Slots)

There are three M.2 sockets on this motherboard.

M.2 sockets: 1 x M.2 (Key E, 2230) with PCIe Gen4 x1, USB 2.0 for Wireless

1 x M.2 (Key M, 2242/2280) with PCIe Gen4 x4 for SSD

1 x M.2 (Key M, 2242) with PCIe Gen4 x4 for SSD

M.2 Key-M Sockets

(M2_M1), (M2_M2)

Pin	Signal Name	Signal Name	Pin
1	GND	+3.3V	2
3	GND	+3.3V	4
5	PERn3	NA	6
7	PERp3	NA	8
9	GND	LED_1#	10
11	PETn3	+3.3V	12
13	PETp3	+3.3V	14
15	GND	+3.3V	16
17	PERn2	+3.3V	18
19	PERp2	NA	20
21	GND	NA	22
23	PETn2	NA	24
25	PETp2	NA	26
27	GND	NA	28
29	PERn1	NA	30
31	PERp1	GND	32
33	GND	USB_D+	34
35	PETn1	USB_D-	36
37	PETp1	GND	38
39	GND	NA	40
41	PERn0	NA	42
43	PERp0	NA	44
45	GND	NA	46
47	PETn0	NA	48
49	PETP0	PERST#	50
51	GND	CLKREQ#	52
53	PEFCLKn	NA	54
55	PEFCLKp	NA	56
57	GND	NA	58
67	NA	NA	68
69	PEDET	+3.3V	70
71	GND	+3.3V	72
73	GND	+3.3V	74
75	GND		

M.2 Key-E Socket (M2E_1)

Pin	Signal Name	Signal Name	Pin
1	GND	+3.3V	2
3	USB_D+	+3.3V	4
5	USB_D-	NA	6
7	GND	NA	8
9	NA	NA	10
11	NA	NA	12
13	NA	NA	14
15	NA	NA	16
17	NA	GND	18
19	NA	NA	20
21	NA	NA	22
23	NA		
		NA	32
33	GND	NA	34
35	PETp	NA	36
37	PETn	NA	38
39	GND	NA	40
41	PERp	NA	42
43	PERn	NA	44
45	GND	NA	46
47	PEFCLKp	NA	48
49	PEFCLKn	SUSCLK	50
51	GND	PERSTO#	52
53	CLKREQ#	NA	54
55	NA	NA	56
57	GND	NA	58
59	NA	NA	60
61	NA	NA	62
63	GND	NA	64
65	NA	NA	66
67	NA	NA	68
69	GND	NA	70
71	NA	+3.3V	72
73	NA	+3.3V	74
75	GND		

Chapter 5 UEFI Setup Utility

5.1 Introduction

ASRock Industrial UEFI (Unified Extensible Firmware Interface) is a BIOS utility which offers tweak-friendly options in an advanced viewing interface. The UEFI system works with a USB mouse and offers users a faster, sleeker experience.

This BIOS utility can perform the Power-On Self-Test (POST) during system startup, record hardware parameters of the system, load operating system, and so on. The battery on the motherboard supplies the power needed to the CMOS when the system power is turned off, and the values configured in the UEFI utility are kept in the CMOS.

Please note that inadequate BIOS settings may cause system instability, malfunction or boot failure. We strongly recommend that you do not alter the UEFI default configurations or change the settings only with the assistance of a trained service person.

If the system becomes unstable or fails to boot after you change the setting, try to clear the CMOS values and reset the board to default values. See your motherboard manual for instructions.

5.1.1 Entering BIOS Setup

You may run the UEFI SETUP UTILITY by pressing <F2> or <Delete> right after you power on the computer; otherwise, the Power-On-Self-Test (POST) will continue with its test routines. If you wish to enter the UEFI SETUP UTILITY after POST, restart the system by pressing <Ctl> + <Alt> + <Delete>, or by pressing the reset button on the system chassis. You may also restart by turning the system off and then back on.

This setup guide explains how to use the UEFI SETUP UTILITY to configure all the supported system. The screenshots in this manual are for reference only. UEFI Settings and options may vary owing to different BIOS release versions or CPU installed. Please refer to the actual BIOS version of the motherboard you purchased for detailed screens, settings and options.

5.1.2 UEFI Menu Bar

The top of the screen has a menu bar with the following selections:

Main For setting system time/date information

Advanced For advanced system configurations

H/W Monitor Displays current hardware status

Security For security settings

Boot For configuring boot settings and boot priority

Exit Exit the current screen or the UEFI Setup Utility



Because the UEFI software is constantly being updated, the following UEFI setup screens and descriptions for reference purpose only, and may vary from the latest BIOS and do not exactly match what you see on your screen.

5.1.3 Navigation Keys

Use <←> key or <→> key to choose among the selections on the menu bar, and use <↑> key or <↓> key to move the cursor up or down to select items, then press <Enter> to get into the sub screen. You can also use the mouse to click your required item.

Please check the following table for the descriptions of each navigation key.

Navigation Key(s)	Description
+ / -	To change option for the selected items
<Tab>	Switch to next function
<PGUP>	Go to the previous page
<PGDN>	Go to the next page
<HOME>	Go to the top of the screen
<END>	Go to the bottom of the screen
<F1>	To display the General Help Screen
<F7>	Discard changes and exit the SETUP UTILITY
<F9>	Load optimal default values for all the settings
<F10>	Save changes and exit the SETUP UTILITY
<F12>	Print screen
<ESC>	Jump to the Exit Screen or exit the current screen

5.2 Main Screen

When you enter the UEFI SETUP UTILITY, the Main screen will appear and display the system overview.

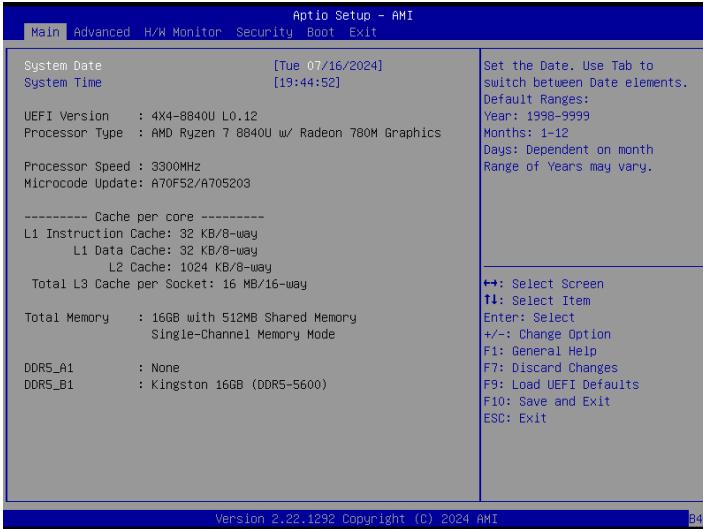

Because the UEFI software is constantly being updated, the following UEFI setup screens and descriptions are for reference purpose only, and they may not exactly match what you see on your screen. Options may also vary depending on the features of your motherboard.

5.3 Advanced Screen

In this section, you may set the configurations for the following items: CPU Configuration, Chipset Configuration, Super IO Configuration, ACPI Configuration, USB Configuration, Power Configuration, and Trusted Computing.

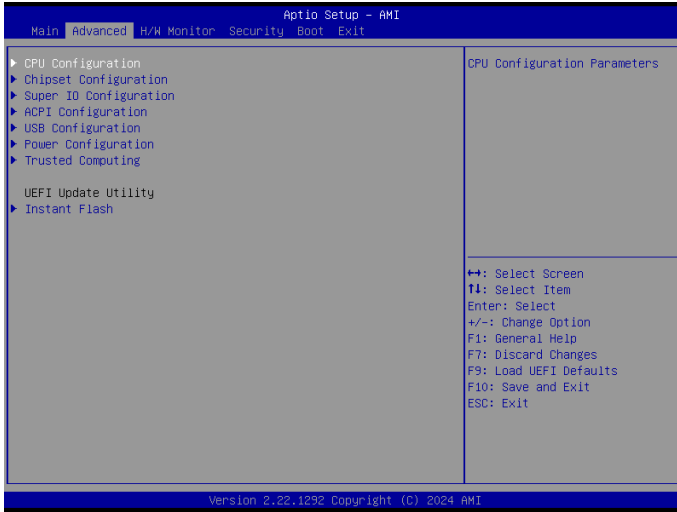

Setting wrong values in this section may cause the system to malfunction.

Instant Flash

Instant Flash is a UEFI flash utility embedded in Flash ROM. This convenient UEFI update tool allows you to update system UEFI without entering operating systems first like Windows®. Just launch this tool and save the new UEFI file to your USB flash drive, floppy disk or hard drive, and then you can update your UEFI in only a few clicks without preparing an additional floppy diskette or other complicated flash utility. Please be noted that the USB flash drive or hard drive must use FAT32/16/12 file system. If you execute Instant Flash utility, the utility will show the UEFI files and their respective information. Select the proper UEFI file to update your UEFI, and reboot your system after UEFI update process completes.

5.3.1 CPU Configuration

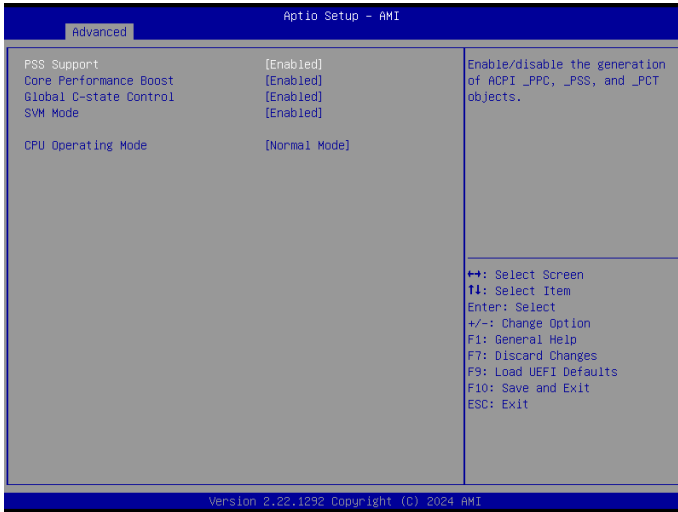

PSS Support

Enable/disable the generation of ACPI_PPC, _PSS, and _PCT objects.

Core Performance Boost

Core Performance Boost controls whether the processor transitions to a higher frequency than the processor's rated speed if the processor has available power and is within temperature specifications. The default value is [Enabled].

Global C-state Control

Enable/Disable Global C-state Control.

SVM Mode

When this is set to [Enabled], a VMM (Virtual Machine Architecture) can utilize the additional hardware capabilities provided by AMD-V. The default value is [Enabled]. Configuration options: [Enabled] and [Disabled].

CPU Operation Mode

If working at [Normal Mode], M/B works with the default Smart Fan Setting and can provide better cooler experience. If [Performance Mode] is selected, CPU can provide optimal performance, but the CPU fan speed will work at higher speed.

5.3.2 Chipset Configuration

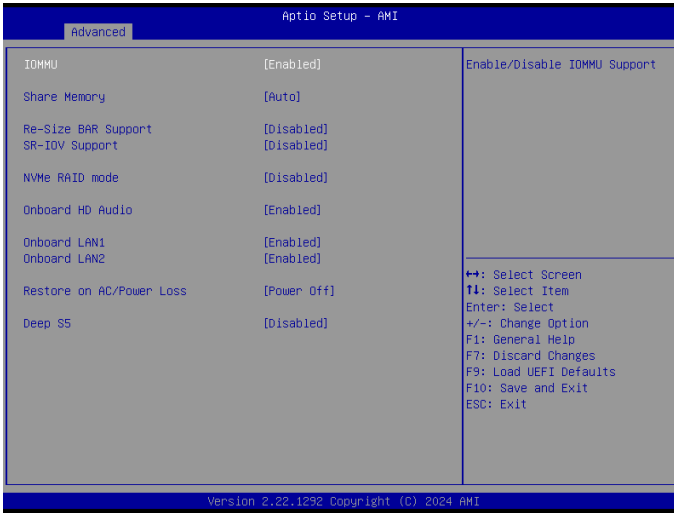

IOMMU

Enable/Disable IOMMU Support.

Share Memory

Share memory allows you to configure the size of memory that is allocated to the integrated graphics processor when the system boots up.

Configuration options: [Auto] [64M] [128M] [256M] [512M] [1024M] [2048M]

Options vary depending on the memory you use on your motherboard.

Re-Size BAR Support

If system has Resizable BAR capable PCIe Devices, this option enables or disables Resizable BAR Support.

SR-IOV Support

If system has SR-IOV capable PCIe Devices, this option Enables or Disables Single Root IO Virtualization Support.

Configuration options: [Enabled] [Disabled]

NVMe RAID Mode

Enable or disable NVMe RAID mode.

Onboard HD Audio

This allows you to enable or disable the onboard HD audio.

Configuration options: [Enabled] [Disabled]

Onboard LAN1

This allows you to enable or disable the Onboard LAN1 feature.

Configuration options: [Enabled] [Disabled]

Onboard LAN2

This allows you to enable or disable the Onboard LAN2 feature.

Configuration options: [Enabled] [Disabled]

Restore on AC/Power Loss

The option allows you to select the power state after a power failure.

[Power Off] sets the power to remain off when the power recovers.

[Power On] sets the system to start to boot up when the power recovers.

Deep S5

Mobile platforms support Deep S5 in DC only and desktop platforms support Deep S5 in

AC only. The default value is [Disabled].

Configuration options: [Auto] [Disabled]

5.3.3 Super IO Configuration

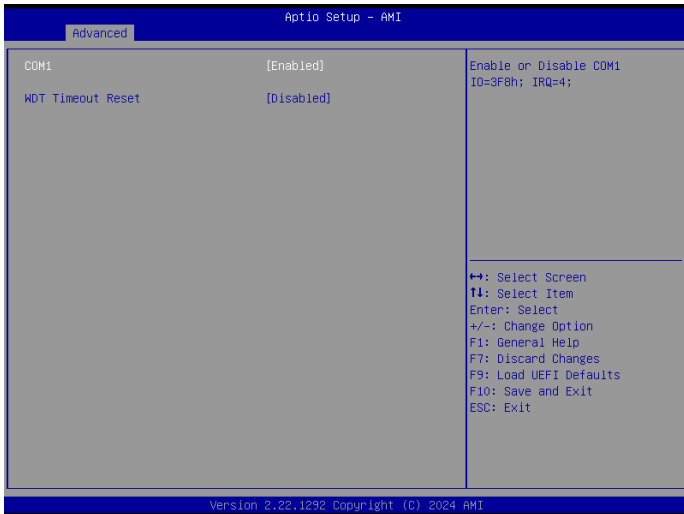

COM1

Use this to set parameters of COM1.

WDT Timeout Reset

Use the item to enable or disable Watch Dog Timer timeout to reset system.

5.3.4 ACPI Configuration

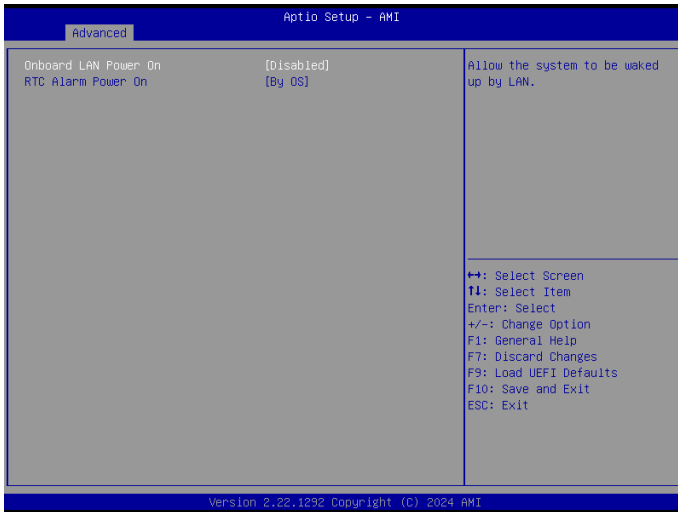

Onboard LAN Power On

Use this item to enable or disable onboard LAN to turn on the system from the power-soft-off mode.

Configuration options: [Enabled] [Disabled]

RTC Alarm Power On

RTC Alarm Power On allows the system to be waked up by the real time clock alarm. Set it to By OS to let it be handled by your operating system.

Configuration options: [Enabled] [Disabled] [By OS]

5.3.5 USB Configuration



USB Power Control

Use this option to control USB power.

5.3.6 Power Configuration

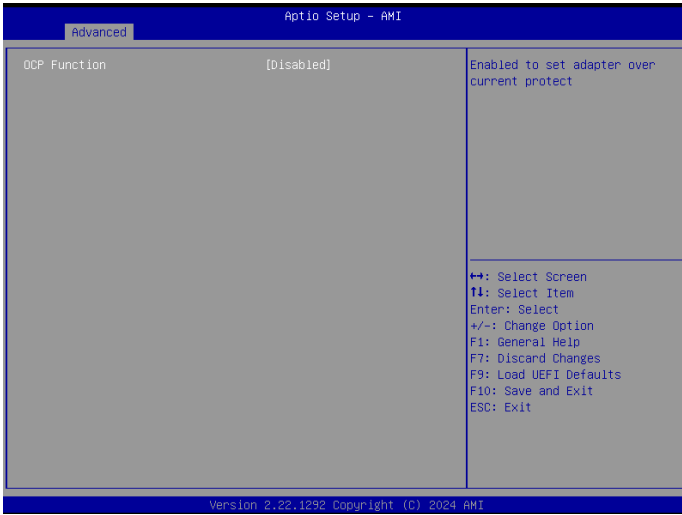

OCP Function

Enabled to set adapter over current protect.

5.3.7 Trusted Computing

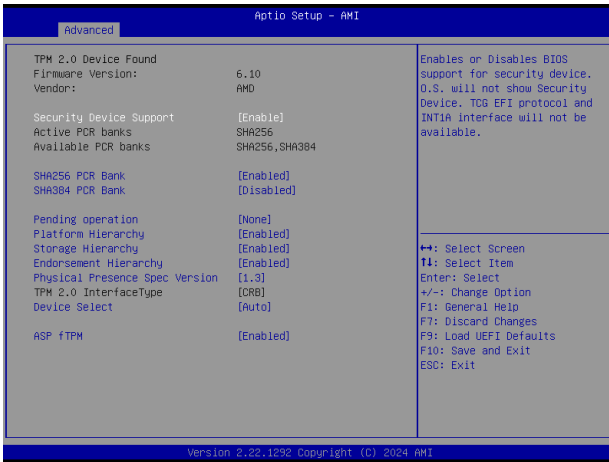

NOTE: Options vary depending on the version of your connected TPM module.

Security Device Support

Security Device Support allows you to enable or disable BIOS support for security device. O.S. will not show Security Device. TCG EFI protocol and INT1A interface will not be available.

Configuration options: [Enabled] [Disabled]

Active PCR banks

This item displays active PCR Banks.

Available PCR Banks

This item displays available PCR Banks.

SHA256 PCR Bank

SHA256 PCR Bank allows you to enable or disable SHA256 PCR Bank.

Configuration options: [Enabled] [Disabled]

SHA384 PCR Bank

SHA384 PCR Bank allows you to enable or disable SHA384 PCR Bank.

Configuration options: [Enabled] [Disabled]

Pending Operation

Pending Operation allows you to schedule an Operation for the Security Device.

NOTE: Your computer will reboot during restart in order to change State of the Device.

Configuration options: [None] [TPM Clear]

Platform Hierarchy

This item allows you to enable or disable Platform Hierarchy.

Configuration options: [Enabled] [Disabled]

Storage Hierarchy

This item allows you to enable or disable Storage Hierarchy.

Configuration options: [Enabled] [Disabled]

Endorsement Hierarchy

This item allows you to enable or disable Endorsement Hierarchy.

Configuration options: [Enabled] [Disabled]

Physical Presence Spec Version

Select this item to tell OS to support PPI spec version 1.2 or 1.3. Please note that some HCK tests might not support version 1.3.

Configuration options: [1.2] [1.3]

TPM 2.0 InterfaceType

This item allows you to view the Communication Interface to TPM 2.0 Device: CRB or ITS.

Device Select

This item allows you to select the TPM device to be supported.

[TPM 1.2] restricts support to TPM 1.2 devices.

[TPM 2.0] restricts support to TPM 2.0 devices.

[Auto] supports both TPM 1.2 and TPM 2.0 devices with the default set to TPM 2.0 devices. If TPM 2.0 devices are not found, TPM 1.2 devices will be enumerated.

ASP fTPM

Enable or disable the AMD fTPM interface controller.

5.4 Hardware Health Event Monitoring Screen

This section allows you to monitor the status of the hardware on your system, including the parameters of the CPU temperature, motherboard temperature, fan speed, and the critical voltage.

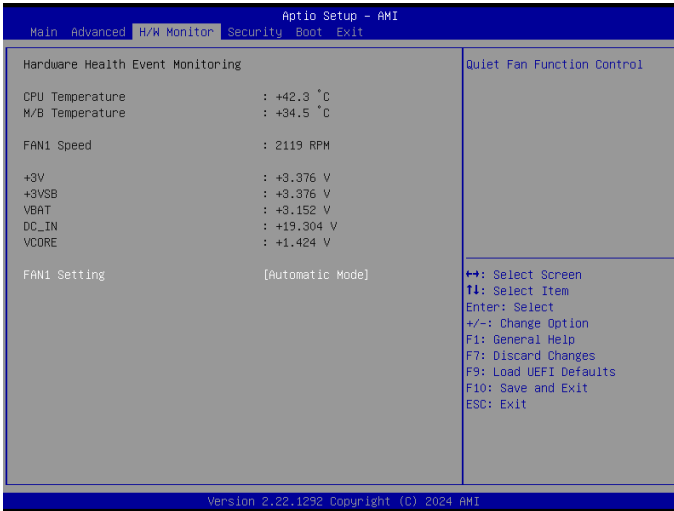

NOTE: Options vary depending on the features of your motherboard.

Fan 1 Setting

This item allows you to select a fan mode for Fan 1. The default value is [Full On].

Configuration options: [Full On] [Manual] [Automatic Mode]

5.5 Security Screen

In this section you may set or change the supervisor/user password for the system. You may also clear the user password.

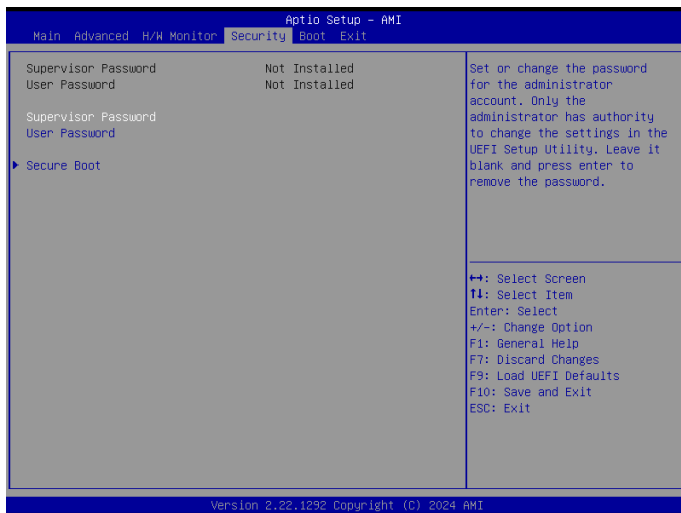

Supervisor Password

Set or change the password for the administrator account. Only the administrator has the authority to change the settings in the UEFI Setup Utility. Leave it blank and press enter to remove the password.

User Password

Set or change the password for the user account. Users are unable to change the settings in the UEFI Setup Utility. Leave it blank and press enter to remove the password.

Secure Boot

Press [Enter] to configure the Secure Boot Settings. The feature protects the system from unauthorized access and malwares during POST.

5.6 Boot Screen

This section displays the available devices on your system for you to configure the boot settings and the boot priority.

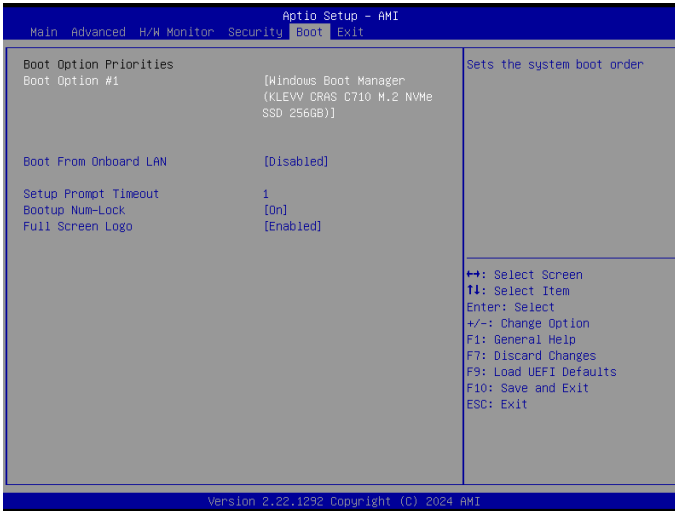

Boot Option #1

The item allows you to set the system boot order.

Boot From Onboard LAN

The item allows the system to be waked up by the onboard LAN.

Configuration options: [Enabled] [Disabled]

Setup Prompt Timeout

The item allows you to configure the number of seconds to wait for the UEFI setup utility.

Configuration options: [1] - [65535]

Bootup Num-Lock

The item allows you to select whether Num Lock should be turned on or off when the system boots up.

Configuration options: [On] [Off]

Full Screen Logo

[Enabled] Select this item to display the boot logo.

[Disabled] Select this item to show normal POST messages.

5.7 Exit Screen

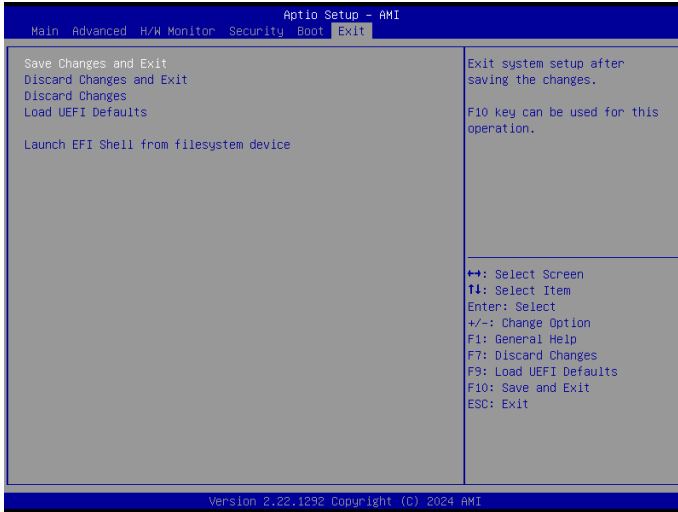

Save Changes and Exit

When you select this option, the following message “Save configuration changes and exit setup?” will pop out. Select [Yes] to save the changes and exit the UEFI SETUP UTILITY.

Discard Changes and Exit

When you select this option, the following message “Discard changes and exit setup?” will pop out. Select [Yes] to exit the UEFI SETUP UTILITY without saving any changes.

Discard Changes

When you select this option, the following message “Discard changes?” will pop out. Select [Yes] to discard all the changes.

Load UEFI Defaults

The item allows you to load UEFI default values for all options. The F9 key can be used for this operation.

Launch EFI Shell from filesystem device

The item allows you to copy shellx64.efi to the root directory to launch EFI Shell.

Chapter 6 Software Support

6.1 Install Operating System

This motherboard supports various Microsoft® Windows® operating systems:

10/11 64-bit. Because motherboard settings and hardware options vary, use the setup procedures in this chapter for general reference only. Refer your OS documentation for more information.