



IMB-194-D

IMB-194-L

User Manual

Version 1.0

Published May 2016

Copyright©2016 ASRock INC. All rights reserved.

Version 1.0

Published May 2016

Copyright©2016 ASRock INC. All rights reserved.

Copyright Notice:

No part of this documentation may be reproduced, transcribed, transmitted, or translated in any language, in any form or by any means, except duplication of documentation by the purchaser for backup purpose, without written consent of ASRock Inc.

Products and corporate names appearing in this documentation may or may not be registered trademarks or copyrights of their respective companies, and are used only for identification or explanation and to the owners' benefit, without intent to infringe.

Disclaimer:

Specifications and information contained in this documentation are furnished for informational use only and subject to change without notice, and should not be constructed as a commitment by ASRock. ASRock assumes no responsibility for any errors or omissions that may appear in this documentation.

With respect to the contents of this documentation, ASRock does not provide warranty of any kind, either expressed or implied, including but not limited to the implied warranties or conditions of merchantability or fitness for a particular purpose.

In no event shall ASRock, its directors, officers, employees, or agents be liable for any indirect, special, incidental, or consequential damages (including damages for loss of profits, loss of business, loss of data, interruption of business and the like), even if ASRock has been advised of the possibility of such damages arising from any defect or error in the documentation or product.



This device complies with Part 15 of the FCC Rules. Operation is subject to the following two conditions:

- (1) this device may not cause harmful interference, and
- (2) this device must accept any interference received, including interference that may cause undesired operation.

CALIFORNIA, USA ONLY

The Lithium battery adopted on this motherboard contains Perchlorate, a toxic substance controlled in Perchlorate Best Management Practices (BMP) regulations passed by the California Legislature. When you discard the Lithium battery in California, USA, please follow the related regulations in advance.

“Perchlorate Material-special handling may apply, see www.dtsc.ca.gov/hazardouswaste/perchlorate”

ASRock Website: <http://www.asrock.com>

CAUTION:

RISK OF EXPLOSION IF BATTERY IS REPLACED BY AN INCORRECT TYPE.
DISPOSE OF USED BATTERIES ACCORDING TO THE INSTRUCTIONS.

The terms HDMI™ and HDMI High-Definition Multimedia Interface, and the HDMI logo are trademarks or registered trademarks of HDMI Licensing LLC in the United States and other countries.



Contents

1 Introduction	5
1.1 Package Contents	5
1.2 Specifications.....	6
1.3 Motherboard Layout.....	10
1.4 I/O Panel.....	12
2 Installation	14
2.1 Screw Holes.....	14
2.2 Pre-installation Precautions	14
2.3 Installation of Memory Modules (SO-DIMM).....	15
2.4 Expansion Slots	17
2.5 Jumpers Setup.....	18
2.6 Onboard Headers and Connectors.....	21
3 UEFI SETUP UTILITY.....	26
3.1 Introduction	26
3.1.1 UEFI Menu Bar	26
3.1.2 Navigation Keys	27
3.2 Main Screen.....	27
3.3 Advanced Screen.....	28
3.3.1 CPU Configuration	29
3.3.2 Chipset Configuration.....	31
3.3.3 Storage Configuration	33
3.3.4 AMT Configuration	34
3.3.5 Super IO Configuration	36
3.3.6 ACPI Configuration.....	37
3.3.7 USB Configuration	38
3.3.8 Trusted Computing.....	39
3.4 Hardware Health Event Monitoring Screen	40
3.5 Security Screen	41
3.6 Boot Screen	42
3.7 Exit Screen	44
4 Software Support	45
4.1 Install Operating System.....	45
4.2 Support CD Information	45
4.2.1 Running Support CD.....	45
4.2.2 Drivers Menu.....	45
4.2.3 Utilities Menu.....	45
4.2.4 Contact Information.....	45

Chapter 1: Introduction

Thank you for purchasing ASRock **IMB-194-D / IMB-194-L** motherboard, a reliable motherboard produced under ASRock's consistently stringent quality control. It delivers excellent performance with robust design conforming to ASRock's commitment to quality and endurance.

In this manual, chapter 1 and 2 contain introduction of the motherboard and step-by-step guide to the hardware installation. Chapter 3 and 4 contain the configuration guide to BIOS setup and information of the Support CD.



Because the motherboard specifications and the BIOS software might be updated, the content of this manual will be subject to change without notice. In case any modifications of this manual occur, the updated version will be available on ASRock website without further notice. You may find the latest VGA cards and CPU support lists on ASRock website as well. ASRock website <http://www.asrock.com>

If you require technical support related to this motherboard, please visit our website for specific information about the model you are using.

www.asrock.com/support/index.asp

1.1 Package Contents

ASRock **IMB-194-D / IMB-194-L** Motherboard

(Mini-ITX Form Factor: 6.7-in x 6.7-in, 17.0 cm x 17.0 cm)

ASRock **IMB-194-D / IMB-194-L** Driver CD

ASRock **IMB-194-D / IMB-194-L** Jumper setting instruction

1 x I/O Panel Shield

1.2 Specifications

IMB-194-D:

Form Factor	Dimensions	Mini-ITX (6.7-in x 6.7-in)
Processor System	CPU	Socket LGA1151 for Intel® Core i7/i5/i3/Celeron (Skylake-S)
	Core Number	(By CPU, Max 4)
	Max Speed	(By CPU)
	L2 Cache	(By CPU)
	Chipset	Intel® Q170
	BIOS	UEFI
Expansion Slot	Mini-PCIe	1 (half/full size, supports PCIe x1 and USB device)
	mSATA	1 (full size, shared with SATA and USB device)
	PCIe	1 x PCIe x16 slot
Memory	Technology	Dual Channel DDR4 2133MHz
	Max.	32GB
	Socket	2 x SO-DIMM
Graphics	Controller	Intel® Gen9 Graphics DX 11/12, OGL4.3/4.4
	VRAM	Shared Memory
	VGA	Supports Max resolution up to 1920 x 1200
	LVDS	0
	HDMI	1
	DVI	0
	DisplayPort	Supports Max resolution up to 4096 x 2160 @ 60Hz
	Multi Display	Yes (Triple Display)
Ethernet	Ethernet	10/100/1000 Mbps
	Controller	1 x Intel® I219LM, 1 x Intel® I210
	Connector	2 x RJ-45
SATA	Max Data Transfer Rate	SATA3 (6.0Gb/s)

Rear I/O	VGA	0
	DVI	0
	HDMI	1
	DisplayPort	2
	Ethernet	2
	USB	4 x USB 3.0
	Audio	2 (Mic-in, Line-out)
	Serial	2 x COM (RS-232/422/485)
	PS/2	0
Internal Connector	USB	4 x USB 2.0 (2 x 2.54 pitch header)
	LVDS/ inverter	0/0
	eDP	1
	VGA	0
	Serial	3 x COM (Supports RS-232 only)
	SATA	4
	mPCIe	1
	Parallel	0
	mSATA	1
	IrDA	0
	GPIO 8-bit	4 x GPI + 4 x GPO
	SATA PWR Output Con	0
	Speaker Header	1
	Watchdog Timer	Output
Interval		256 segments, 0,1,2...255sec/min
Power Requirements	Input PWR	ATX PWR Con (24+4-pin)
	Power On	AT/ATX Supported AT : Directly PWR on as power input ready ATX : Press button to PWR on after power input ready
Environment	Temperature	0°C – 60°C

IMB-194-L:

Form Factor	Dimensions	Mini-ITX (6.7-in x 6.7-in)
Processor System	CPU	Socket LGA1151 for Intel® Core i7/i5/i3/Celeron (Skylake-S)
	Core Number	(By CPU, Max 4)
	Max Speed	(By CPU)
	L2 Cache	(By CPU)
	Chipset	Intel® Q170
	BIOS	UEFI
Expansion Slot	Mini-PCIe	1 (half/full size, supports PCIe x1 and USB device)
	mSATA	1 (full size, shared with SATA and USB device)
	PCIe	1 x PCIe x16 slot
Memory	Technology	Dual Channel DDR4 2133MHz
	Max.	32GB
	Socket	2 x SO-DIMM
Graphics	Controller	Intel® Gen9 Graphics DX 11/12, OGL4.3/4.4
	VRAM	Shared Memory
	VGA	Supports Max resolution up to 1920 x 1200
	LVDS	Supports Max resolution up to 1920 x 1200 @ 60Hz
	HDMI	1
	DVI	0
	DisplayPort	Supports Max resolution up to 4096 x 2160 @ 60Hz
	Multi Display	Yes (Triple Display)
Ethernet	Ethernet	10/100/1000 Mbps
	Controller	1 x Intel® I219LM, 1 x Intel® I210
	Connector	2 x RJ-45
SATA	Max Data Transfer Rate	SATA3 (6.0Gb/s)

Rear I/O	VGA	1
	DVI	0
	HDMI	0
	DisplayPort	1
	Ethernet	2
	USB	4 x USB 3.0
	Audio	2 (Mic-in, Line-out)
	Serial	2 x COM (RS-232/422/485)
	PS/2	0
Internal Connector	USB	4 x USB 2.0 (2 x 2.54 pitch header)
	LVDS/ inverter	1/1
	eDP	0
	VGA	0
	Serial	3 x COM (Supports RS-232 only)
	SATA	4
	mPCIe	1
	Parallel	0
	mSATA	1
	IrDA	0
	GPIO 8-bit	4 x GPI + 4 x GPO
	SATA PWR Output Con	0
	Speaker Header	1
	Watchdog Timer	Output
Interval		256 segments, 0,1,2...255sec/min
Power Requirements	Input PWR	ATX PWR Con (24+4-pin)
	Power On	AT/ATX Supported AT : Directly PWR on as power input ready ATX : Press button to PWR on after power input ready
Environment	Temperature	0°C – 60°C

1.3 Motherboard Layout

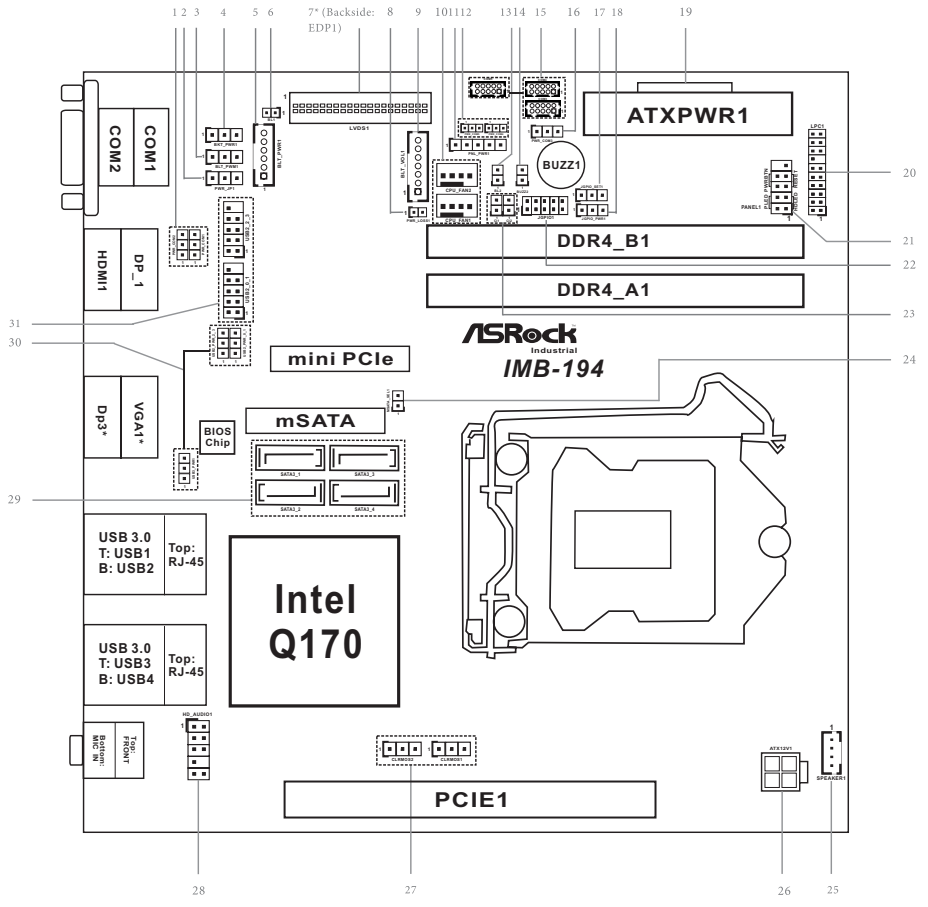

-
- 1 : COM Port PWR Setting Jumper (PWR_COM1 (For COM Port1))
COM Port PWR Setting Jumper (PWR_COM2 (For COM Port2))
 - 2 : ATX/AT Mode Select (PWR_JP1)
 - 3 : Backlight Control Level (BLT_PWM1)
 - 4 : Backlight Power Select (LCD_BLT_VCC) (BKT_PWR1)
 - 5 : Inverter Power Control Wafer (BLT_PWR1)
 - 6 : BL1
 - 7* : LVDS Panel Connector (For IMB-194-L only)
eDP Connector (For IMB-194-D only) (on the Backside of PCB)
 - 8 : Power Loss Jumper (PWR_LOSS1)
 - 9 : Backlight Volume Control (BLT_VOL1)
 - 10 : 4-Pin CPU FAN Connectors (+12V) (CPU_FAN1, CPU_FAN2)
 - 11 : Panel Power Select (LCD_VCC) (PNL_PWR1)
 - 12 : COM Port PWR Setting Jumper (PWR_COM4 (For COM Port4))
COM Port PWR Setting Jumper (PWR_COM5 (For COM Port5))
 - 13 : BL2
 - 14 : Buzzer
 - 15 : COM3, 4, 5 Headers (RS232)
 - 16 : COM Port PWR Setting Jumper (PWR_COM3 (For COM Port3))
 - 17 : Digital Input / Output Default Value Setting (JGPIO_SET1)
 - 18 : Digital Input / Output Power Select (JGIOPWR) (JGPIO_PWR1)
 - 19 : 24-pin ATX Power Input Connector
 - 20 : LPC Header
 - 21 : System Panel Header
 - 22 : Digital Input/Output Pin Header (JGPIO1)
 - 23 : Chassis Intrusion Headers (CI1, CI2)
 - 24 : MSATA Select (MSATA_SEL1)
 - 25 : 3W Audio AMP Output Wafer
 - 26 : 4-pin ATX Power Input/Output Connector
 - 27 : Clear CMOS Headers (CLRMOS1, CLRMOS2)
 - 28 : Front Panel Audio Header
 - 29 : SATA3 Connectors (SATA3_1, SATA3_2, SATA3_3, SATA3_4)
 - 30 : USB Power Setting Jumper (USB2_PWR_0_1 (For USB2_0_1))
USB Power Setting Jumper (USB2_PWR_2_3 (For USB2_2_3))
USB Power Setting Jumper (USB3_PWR1 (For USB3_12, USB3_34))
 - 31 : USB2.0 Headers (USB2_0_1, USB2_2_3)

* VGA1 is for IMB-194-L only. DP3 is for IMB-194-D only.

1.4 I/O Panel IMB-194-D:

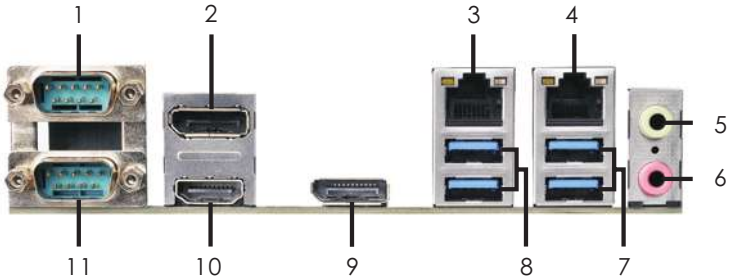

- | | | | |
|---|--------------------|----|--------------------------|
| 1 | COM Port (COM1)* | 7 | USB 3.0 Ports (USB3_3_4) |
| 2 | DisplayPort (DP_1) | 8 | USB 3.0 Ports (USB3_1_2) |
| 3 | LAN RJ-45 Port** | 9 | DisplayPort (DP3) |
| 4 | LAN RJ-45 Port** | 10 | HDMI Port (HDMI1) |
| 5 | Line out (Lime) | 11 | COM Port (COM2)* |
| 6 | Microphone (Pink) | | |

* This motherboard supports RS232/422/485 on COM1, 2 ports. Please refer to below table for the pin definition. In addition, COM1, 2 ports (RS232/422/485) can be adjusted in BIOS setup utility > Advanced Screen > Super IO Configuration. You may refer to page 36 for details.

COM1, 2 Port Pin Definition

PIN	RS232	RS422	RS485
1	DCD	TX-	RTX-
2	RXD	RX+	N/A
3	TXD	TX+	RTX+
4	DTR	RX-	N/A
5	GND	GND	GND
6	DSR	N/A	N/A
7	RTS	N/A	N/A
8	CTS	N/A	N/A
9	+5V / +12V	N/A	N/A

** There are two LED next to the LAN port. Please refer to the table below for the LAN port LED indications.

LAN Port LED Indications

Activity/Link LED	
Status	Description
Off	No Link
Blinking	Data Activity
On	Link

SPEED LED	
Status	Description
Off	10Mbps connection
Off	100Mbps connection
Green	1Gbps connection

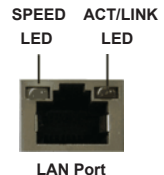

IMB-194-L:

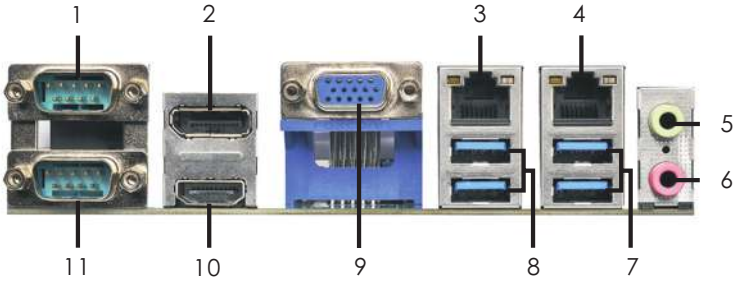

- | | | | |
|---|--------------------|----|--------------------------|
| 1 | COM Port (COM1)* | 7 | USB 3.0 Ports (USB3_3_4) |
| 2 | DisplayPort (DP_1) | 8 | USB 3.0 Ports (USB3_1_2) |
| 3 | LAN RJ-45 Port** | 9 | D-Sub Port (VGA1) |
| 4 | LAN RJ-45 Port** | 10 | HDMI Port (HDMI1) |
| 5 | Line out (Lime) | 11 | COM Port (COM2)* |
| 6 | Microphone (Pink) | | |

* This motherboard supports RS232/422/485 on COM1, 2 ports. Please refer to below table for the pin definition. In addition, COM1, 2 ports (RS232/422/485) can be adjusted in BIOS setup utility > Advanced Screen > Super IO Configuration. You may refer to page 36 for details.

COM1, 2 Port Pin Definition

PIN	RS232	RS422	RS485
1	DCD	TX-	RTX-
2	RXD	RX+	N/A
3	TXD	TX+	RTX+
4	DTR	RX-	N/A
5	GND	GND	GND
6	DSR	N/A	N/A
7	RTS	N/A	N/A
8	CTS	N/A	N/A
9	+5V / +12V	N/A	N/A

** There are two LED next to the LAN port. Please refer to the table below for the LAN port LED indications.

LAN Port LED Indications

Activity/Link LED		SPEED LED	
Status	Description	Status	Description
Off	No Link	Off	10Mbps connection
Blinking	Data Activity	Off	100Mbps connection
On	Link	Green	1Gbps connection

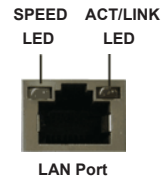

Chapter 2: Installation

This is a Mini-ITX form factor (6.7" x 6.7", 17.0 x 17.0 cm) motherboard. Before you install the motherboard, study the configuration of your chassis to ensure that the motherboard fits into it.



Make sure to unplug the power cord before installing or removing the motherboard. Failure to do so may cause physical injuries to you and damages to motherboard components.

2.1 Screw Holes

Place screws into the holes to secure the motherboard to the chassis.



Do not over-tighten the screws! Doing so may damage the motherboard.

2.2 Pre-installation Precautions

Take note of the following precautions before you install motherboard components or change any motherboard settings.

1. Unplug the power cord from the wall socket before touching any component.
2. To avoid damaging the motherboard components due to static electricity, NEVER place your motherboard directly on the carpet or the like. Also remember to use a grounded wrist strap or touch a safety grounded object before you handle components.
3. Hold components by the edges and do not touch the ICs.
4. Whenever you uninstall any component, place it on a grounded antistatic pad or in the bag that comes with the component.



Before you install or remove any component, ensure that the power is switched off or the power cord is detached from the power supply. Failure to do so may cause severe damage to the motherboard, peripherals, and/or components.

2.3 Installation of Memory Modules (SO-DIMM)

IMB-194-D / IMB-194-L provides two 260-pin DDR4 (Double Data Rate 4) SO-DIMM slots.



1. The SO-DIMM only fits in one correct orientation. It will cause permanent damage to the motherboard and the SO-DIMM if you force the SO-DIMM into the slot at incorrect orientation.
2. Please do not intermix different voltage SO-DIMMs on this motherboard.

1

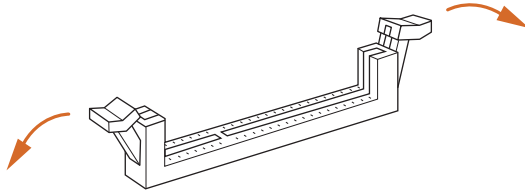

2

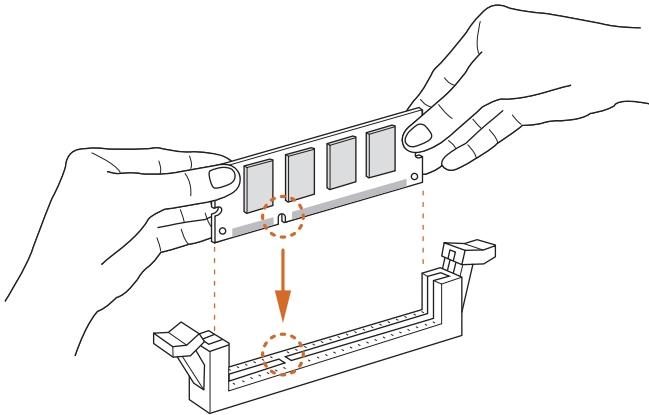

3

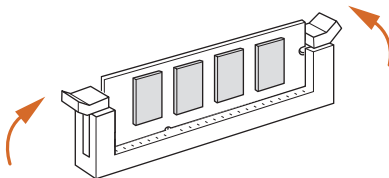

2.4 Expansion Slots

There is 1 mini-PCIe slot, 1 mini-SATA slot and 1 PCI Express slot on this motherboard.

mini-PCIe slot:

MINI_PCIE1 (mini-PCIe slot; half/full size) is used for PCI Express mini cards.

mini-SATA slot:

MINI_SATA1 (mini-SATA slot; full size) is used for mSATA cards.

PCIe slot: PCIE1 (PCIe x16 slot) is used for PCI Express x16 lane width cards.

Installing an expansion card

- Step 1. Before installing the expansion card, please make sure that the power supply is switched off or the power cord is unplugged. Please read the documentation of the expansion card and make necessary hardware settings for the card before you start the installation.
- Step 2. Remove the system unit cover (if your motherboard is already installed in a chassis).
- Step 3. Remove the bracket facing the slot that you intend to use. Keep the screws for later use.
- Step 4. Align the card connector with the slot and press firmly until the card is completely seated on the slot.
- Step 5. Fasten the card to the chassis with screws.
- Step 6. Replace the system cover.

2.5 Jumpers Setup

The illustration shows how jumpers are setup. When the jumper cap is placed on pins, the jumper is “Short”. If no jumper cap is placed on pins, the jumper is “Open”. The illustration shows a 3-pin jumper whose pin1 and pin2 are “Short” when jumper cap is placed on these 2 pins.

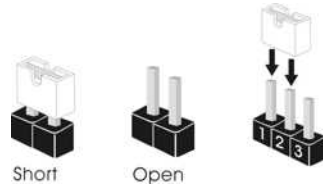

Jumper	Setting	Description
Clear CMOS Jumpers (3-pin CLRMOS1, CLRMOS2) (see p.10, No. 27)	<div style="display: flex; justify-content: space-around; align-items: center;"> <div style="text-align: center;"> <p>1_2</p> <p>Default</p> </div> <div style="text-align: center;"> <p>2_3</p> <p>Clear CMOS</p> </div> </div>	CLRMOS1 : 1-2 : Normal 2-3 : Clear CMOS CLRMOS2 : 1-2 : +BATT 2-3 : +3VSB_A

Note: CLRMOS1 allows you to clear the data in CMOS. To clear and reset the system parameters to default setup, please turn off the computer and unplug the power cord from the power supply. After waiting for 15 seconds, use a jumper cap to short pin2 and pin3 on CLRMOS1 for 5 seconds. However, please do not clear the CMOS right after you update the BIOS. If you need to clear the CMOS when you just finish updating the BIOS, you must boot up the system first, and then shut it down before you do the clear-CMOS action. Please be noted that the password, date, time, user default profile and MAC address will be cleared only if the CMOS battery is removed.

AT/ATX Mode Select (3-pin PWR_JP1) (see p.10, No. 2)	<p style="text-align: center;">1 2 3</p>	1-2 : AT Mode 2-3 : ATX Mode
Digital Input / Output Power Select (JGPIO_PWR) (3-pin JGPIO_PWR1) (see p.10, No. 18)	<p style="text-align: center;">1 2 3</p>	1-2 : +12V 2-3 : +5V
Digital Input / Output Default Value Setting (3-pin JGPIO_SET1) (see p.10, No. 17)	<p style="text-align: center;">1 2 3</p>	1-2 : Pull-High 2-3 : Pull-Low

Backlight Control Level

(3-pin BLT_PWM1)

(see p.10, No. 3)



1-2 : +3V (eDP)

2-3 : +5V (LVDS)

Backlight Power Select (LCD_BLT_VCC)

(3-pin BKT_PWR1)

(see p.10, No. 4)



1-2 : LCD_BLT_VCC : +5V

2-3 : LCD_BLT_VCC : +12V

COM Port PWR Setting Jumpers

(3-pin PWR_COM1 (For COM Port1),

PWR_COM2 (For COM Port2))

(see p.10, No. 1)



1-2 : +5V

2-3 : +12V

(3-pin PWR_COM4 (For COM Port4),

PWR_COM5 (For COM Port5))

(see p.10, No. 12)



(3-pin PWR_COM3 (For COM Port3))

(see p.10, No. 16)



BL1, BL2

(2-pin BL1)

(see p.10 No. 6)



(2-pin BL2)

(see p.10 No. 13)



mSATA Select

(2-pin MSATA_SEL1)

(see p.10, No. 24)



Open : For SATA3_1

Short : For mSATA

Power Loss Jumper

(2-pin PWR_LOSS1)

(see p.10, No. 8)



Open : Power Loss

Close : no Power Loss

Panel Power Select (LCD_VCC)

(5-pin PNL_PWR1)

(see p.10, No. 11)



1-2 : LCD_VCC : +3V

2-3 : LCD_VCC : +5V

4-5 : LCD_VCC : +12V

USB Power Setting Jumpers

(3-pin USB2_PWR_0_1 (For USB2_0_1),

USB2_PWR_2_3 (For USB2_2_3),

USB3_PWR1 (For USB3_12, USB3_34))

(see p.10, No. 30)



1-2 : +5V

2-3 : +5VSB

2.6 Onboard Headers and Connectors



Onboard headers and connectors are NOT jumpers. Do NOT place jumper caps over these headers and connectors. Placing jumper caps over the headers and connectors will cause permanent damage of the motherboard!

CPU Fan Connectors
 (4-pin CPU_FAN1, CPU_FAN2)
 (see p.10 No. 10)

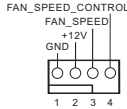

Please connect the CPU fan cable to the connector and match the black wire to the ground pin.



Though this motherboard provides 4-Pin CPU fan (Quiet Fan) support, the 3-Pin CPU fan still can work successfully even without the fan speed control function. If you plan to connect the 3-Pin CPU fan to the CPU fan connector on this motherboard, please connect it to Pin 1-3.

Digital Input / Output Pin Header

(10-pin JGPIO1)
 (see p.10, No. 22)

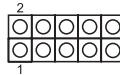

PIN	Signal Name	PIN	Signal Name	PIN	Signal Name	PIN	Signal Name	PIN	Signal Name
2	SIO_GP20	4	SIO_GP21	6	SIO_GP22	8	SIO_GP23	10	GND
1	SIO_GP24	3	SIO_GP25	5	SIO_GP26	7	SIO_GP27	9	JGPIO_PWR

Chassis Intrusion Headers

(2-pin C11, C12: see p.10, No. 23)



This motherboard supports CASE OPEN detection feature that detects if the chassis cover has been removed. This feature requires a chassis with chassis intrusion detection design.

C11 :

Close : Active Case Open

Open : Normal

C12 :

Close : Normal

Open : Active Case Open

COM3, 4, 5 Headers (RS232)

(10-pin COM3, 4, 5: see p.10, No. 15)

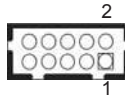

PIN	Signal Name	PIN	Signal Name	PIN	Signal Name	PIN	Signal Name	PIN	Signal Name
10	NC	8	CCTS#	6	DDSR#	4	DDTR#	2	RRXD
9	+5V / +12V	7	RRTS#	5	GND	3	TTXD	1	DDCD#

System Panel Header

(9-pin PANEL1)

(see p.10, No. 21)

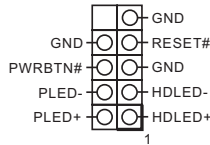

This header accommodates several system front panel functions.



Connect the power switch, reset switch and system status indicator on the chassis to this header according to the pin assignments below. Note the positive and negative pins before connecting the cables.

PWRBTN (Power Switch):

Connect to the power switch on the chassis front panel. You may configure the way to turn off your system using the power switch.

RESET (Reset Switch):

Connect to the reset switch on the chassis front panel. Press the reset switch to restart the computer if the computer freezes and fails to perform a normal restart.

PLED (System Power LED):

Connect to the power status indicator on the chassis front panel. The LED is on when the system is operating. The LED keeps blinking when the system is in S1/S3 sleep state. The LED is off when the system is in S4 sleep state or powered off (S5).

HDLED (Hard Drive Activity LED):

Connect to the hard drive activity LED on the chassis front panel. The LED is on when the hard drive is reading or writing data.

The front panel design may differ by chassis. A front panel module mainly consists of power switch, reset switch, power LED, hard drive activity LED, speaker and etc. When connecting your chassis front panel module to this header, make sure the wire assignments and the pin assignments are matched correctly.

Buzzer

(2-pin BUZZ2)

(see p.10 No. 14)



SATA3 Connectors

(SATA3_1~4: see p.10, No. 29)



These four Serial ATA3 (SATA3) connectors support SATA data cables for internal storage devices. The current SATA3 interface allows up to 6.0 Gb/s data transfer rate.

USB 2.0 Headers

(9-pin USB2_0_1, USB2_2_3:
see p.10, No. 31)

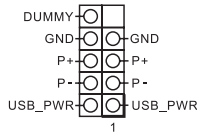

There are two headers on this motherboard. Each USB 2.0 header can support two ports.

Front Panel Audio Header

(9-pin HD_AUDIO1)
(see p.10 No. 28)

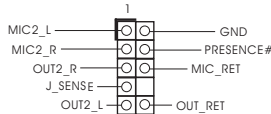

This is an interface for front panel audio cable that allows convenient connection and control of audio devices.



1. High Definition Audio supports Jack Sensing, but the panel wire on the chassis must support HDA to function correctly. Please follow the instruction in our manual and chassis manual to install your system.
2. If you use AC'97 audio panel, please install it to the front panel audio header as below:
 - A. Connect Mic_IN (MIC) to MIC2_L.
 - B. Connect Audio_R (RIN) to OUT2_R and Audio_L (LIN) to OUT2_L.
 - C. Connect Ground (GND) to Ground (GND).
 - D. MIC_RET and OUT_RET are for HD audio panel only. You don't need to connect them for AC'97 audio panel.
 - E. To activate the front mic.

Go to the "FrontMic" Tab in the Realtek Control panel. Adjust "Recording Volume".

LPC Header

(19-pin LPC1)
(see p.10, No. 20)

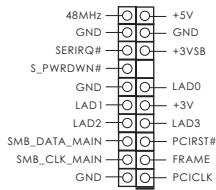

This connector supports a Trusted Platform Module (TPM) system, which can securely store keys, digital certificates, passwords, and data. A TPM system also helps enhance network security, protects digital identities, and ensures platform integrity.

ATX Power Input/Output Connector

(4-pin ATX12V1)
(see p.10 No. 26)

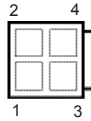

Please connect a DC power supply to this connector.
1-2 : GND
3-4 : DC Input

ATX Power Input Connector

(24-pin ATXPWR1)
(see p.10 No. 19)

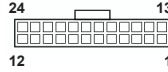

This motherboard provides a 24-pin ATX power connector. To use a 20-pin ATX power supply, please plug it along Pin 1 and Pin 13.

* LVDS Connector (Only for IMB-194-L)

(40-pin LVDS1)
(see p.10 No. 7)

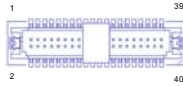

PIN	Signal Name	PIN	Signal Name
1	LCD_VCC	1	LCD_VCC
2	LCD_VCC	2	LCD_VCC
3	+3.3V	3	+3.3V
4	LVDS_A_DATA0#	4	LVDS_A_DATA0#
5	LVDS_A_DATA1#	5	LVDS_A_DATA1#
6	LVDS_A_DATA2#	6	LVDS_A_DATA2#
7	LVDS_A_DATA3#	7	LVDS_A_DATA3#
8	LVDS_A_CLK#	8	LVDS_A_CLK#
9	LVDS_A_DATA0	9	LVDS_A_DATA0
10	LVDS_A_DATA1	10	LVDS_A_DATA1
11	LVDS_A_DATA2	11	LVDS_A_DATA2
12	LVDS_A_DATA3	12	LVDS_A_DATA3
13	LVDS_A_CLK	13	LVDS_A_CLK
14	LVDS_B_DATA0	14	LVDS_B_DATA0
15	LVDS_B_DATA1	15	LVDS_B_DATA1
16	LVDS_B_DATA2	16	LVDS_B_DATA2
17	LVDS_B_DATA3	17	LVDS_B_DATA3
18	LVDS_B_CLK	18	LVDS_B_CLK
19	LVDS_B_DATA0	19	LVDS_B_DATA0
20	LVDS_B_DATA1	20	LVDS_B_DATA1
21	LVDS_B_DATA2	21	LVDS_B_DATA2
22	LVDS_B_DATA3	22	LVDS_B_DATA3
23	LVDS_B_CLK	23	LVDS_B_CLK
24	LVDS_B_DATA0	24	LVDS_B_DATA0
25	LVDS_B_DATA1	25	LVDS_B_DATA1
26	LVDS_B_DATA2	26	LVDS_B_DATA2
27	LVDS_B_DATA3	27	LVDS_B_DATA3
28	LVDS_B_CLK	28	LVDS_B_CLK
29	LVDS_B_DATA0	29	LVDS_B_DATA0
30	LVDS_B_DATA1	30	LVDS_B_DATA1
31	LVDS_B_DATA2	31	LVDS_B_DATA2
32	LVDS_B_DATA3	32	LVDS_B_DATA3
33	LVDS_B_CLK	33	LVDS_B_CLK
34	CON_LBKLT_EN	34	CON_LBKLT_EN
35	CON_LBKLT_CTL	35	CON_LBKLT_CTL
36	CON_LBKLT_VCC	36	CON_LBKLT_VCC
37	LCD_BLT_VCC	37	LCD_BLT_VCC
38	LCD_BLT_VCC	38	LCD_BLT_VCC
39	LCD_BLT_VCC	39	LCD_BLT_VCC
40	LCD_BLT_VCC	40	LCD_BLT_VCC

eDP Connector (For IMB-194-D only)

(on the Backside of PCB)
(40-pin EDP1)
(see p.10 No. 7)



PIN	Signal Name	PIN	Signal Name
1	NA	1	NA
2	NA	2	NA
3	eDP_TX3_CON	3	eDP_TX3_CON
4	eDP_TX3_CON	4	eDP_TX3_CON
5	eDP_TX3_CON	5	eDP_TX3_CON
6	eDP_TX2_CON	6	eDP_TX2_CON
7	eDP_TX2_CON	7	eDP_TX2_CON
8	eDP_TX2_CON	8	eDP_TX2_CON
9	eDP_TX1_CON	9	eDP_TX1_CON
10	eDP_TX1_CON	10	eDP_TX1_CON
11	eDP_TX0_CON	11	eDP_TX0_CON
12	eDP_TX0_CON	12	eDP_TX0_CON
13	eDP_TX0_CON	13	eDP_TX0_CON
14	eDP_AUX_CON	14	eDP_AUX_CON
15	eDP_AUX_CON	15	eDP_AUX_CON
16	eDP_AUX_CON	16	eDP_AUX_CON
17	LCD_VCC	17	LCD_VCC
18	LCD_VCC	18	LCD_VCC
19	LCD_VCC	19	LCD_VCC
20	LCD_VCC	20	LCD_VCC
21	LCD_VCC	21	LCD_VCC
22	NA	22	NA
23	NA	23	NA
24	NA	24	NA
25	NA	25	NA
26	NA	26	NA
27	NA	27	NA
28	NA	28	NA
29	NA	29	NA
30	NA	30	NA
31	NA	31	NA
32	CON_LBKLT_EN	32	CON_LBKLT_EN
33	CON_LBKLT_CTL	33	CON_LBKLT_CTL
34	CON_LBKLT_VCC	34	CON_LBKLT_VCC
35	LCD_BLT_VCC	35	LCD_BLT_VCC
36	LCD_BLT_VCC	36	LCD_BLT_VCC
37	LCD_BLT_VCC	37	LCD_BLT_VCC
38	LCD_BLT_VCC	38	LCD_BLT_VCC
39	LCD_BLT_VCC	39	LCD_BLT_VCC
40	LCD_BLT_VCC	40	LCD_BLT_VCC

3W Audio AMP Output Wafer

(4-pin SPEAKER1)
(see p.10 No. 25)



PIN	Signal Name
1	OUTLN
2	OUTLP
3	OUTRP
4	OUTRN

Inverter Power Control Wafer

(6-pin BLT_PWR1)

(see p.10 No. 5)



1

PIN	Signal Name
6	LCD_BLT_VCC
5	LCD_BLT_VCC
4	CON_LBKL_T_EN
3	CON_LBKL_CTL
2	GND
1	GND

Backlight Volume Control

(7-pin BLT_VOL1)

(see p.10 No. 9)



1

PIN	Signal Name
7	GND
6	GND
5	BLT_DW
4	BLT_UP
3	PWRDN
2	GPIO_VOL_DW
1	GPIO_VOL_UP

Chapter 3: UEFI SETUP UTILITY

3.1 Introduction

This section explains how to use the UEFI SETUP UTILITY to configure your system. The UEFI chip on the motherboard stores the UEFI SETUP UTILITY. You may run the UEFI SETUP UTILITY when you start up the computer. Please press <F2> or during the Power-On-Self-Test (POST) to enter the UEFI SETUP UTILITY, otherwise, POST will continue with its test routines.

If you wish to enter the UEFI SETUP UTILITY after POST, restart the system by pressing <Ctl> + <Alt> + <Delete>, or by pressing the reset button on the system chassis. You may also restart by turning the system off and then back on.



Because the UEFI software is constantly being updated, the following UEFI setup screens and descriptions are for reference purpose only, and they may not exactly match what you see on your screen.

3.1.1 UEFI Menu Bar

The top of the screen has a menu bar with the following selections:

Main	To set up the system time/date information
Advanced	To set up the advanced UEFI features
H/W Monitor	To display current hardware status
Security	To set up the security features
Boot	To set up the default system device to locate and load the Operating System
Exit	To exit the current screen or the UEFI SETUP UTILITY

Use <←> key or <→> key to choose among the selections on the menu bar, and then press <Enter> to get into the sub screen. You can also use the mouse to click your required item.

3.1.2 Navigation Keys

Please check the following table for the function description of each navigation key.

Navigation Key(s)	Function Description
← / →	Moves cursor left or right to select Screens
↑ / ↓	Moves cursor up or down to select items
+ / -	To change option for the selected items
<Enter>	To bring up the selected screen
<F1>	To display the General Help Screen
<F7>	Discard changes
<F9>	To load optimal default values for all the settings
<F10>	To save changes and exit the UEFI SETUP UTILITY
<F12>	Print screen
<ESC>	To jump to the Exit Screen or exit the current screen

3.2 Main Screen

When you enter the UEFI SETUP UTILITY, the Main screen will appear and display the system overview.

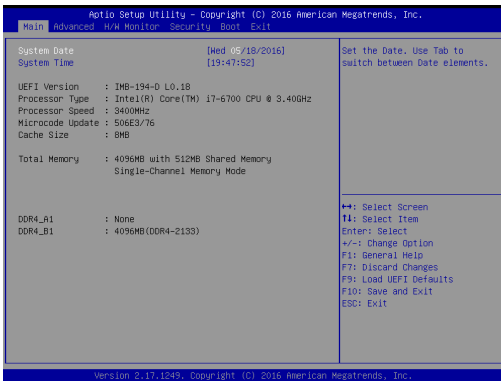

3.3 Advanced Screen

In this section, you may set the configurations for the following items: CPU Configuration, Chipset Configuration, Storage Configuration, AMT Configuration, Super IO Configuration, ACPI Configuration, USB Configuration and Trusted Computing.

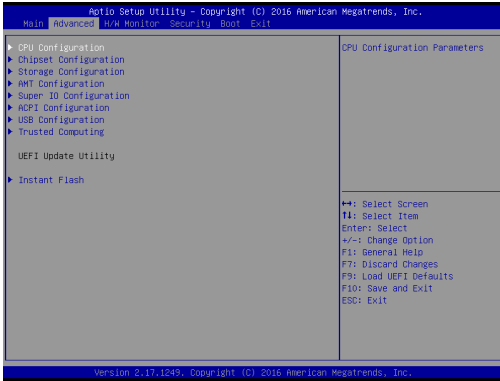

Setting wrong values in this section may cause the system to malfunction.

Instant Flash

Instant Flash is a UEFI flash utility embedded in Flash ROM. This convenient UEFI update tool allows you to update system UEFI without entering operating systems first like MS-DOS or Windows®. Just launch this tool and save the new UEFI file to your USB flash drive, floppy disk or hard drive, then you can update your UEFI only in a few clicks without preparing an additional floppy diskette or other complicated flash utility. Please be noted that the USB flash drive or hard drive must use FAT32/16/12 file system. If you execute Instant Flash utility, the utility will show the UEFI files and their respective information. Select the proper UEFI file to update your UEFI, and reboot your system after UEFI update process completes.

3.3.1 CPU Configuration

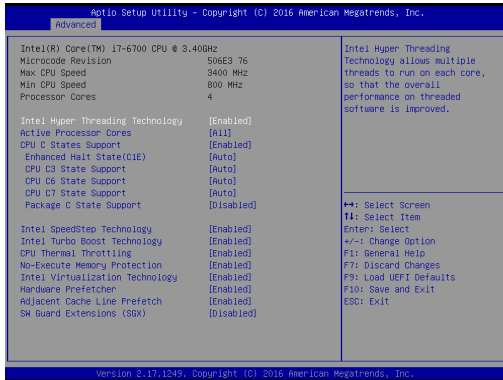

Intel Hyper Threading Technology

Intel Hyper Threading Technology allows multiple threads to run on each core, so that the overall performance on threaded software is improved.

Active Processor Cores

Select the number of cores to enable in each processor package.

CPU C States Support

Enable CPU C States Support for power saving. It is recommended to keep C3, C6 and C7 all enabled for better power saving.

Enhanced Halt State (C1E)

Enable Enhanced Halt State (C1E) for lower power consumption.

CPU C3 State Support

Enable C3 sleep state for lower power consumption.

CPU C6 State Support

Enable C6 deep sleep state for lower power consumption.

CPU C7 State Support

Enable C7 deep sleep state for lower power consumption.

Package C State Support

Enable CPU, PCIe, Memory, Graphics C State Support for power saving.

Intel SpeedStep Technology

Intel SpeedStep technology is Intel's new power saving technology. Processors can switch between multiple frequencies and voltage points to enable power saving. The default value is [Enabled]. Configuration options: [Enabled] and [Disabled]. If you install Windows® 7 / 8 / 8.1 / 10 and want to enable this function, please set this item to [Enabled]. This item will be hidden if the current CPU does not support Intel SpeedStep technology.



Please note that enabling this function may reduce CPU voltage and lead to system stability or compatibility issues with some power supplies. Please set this item to [Disabled] if above issues occur.

Intel Turbo Boost Technology

Use this item to enable or disable Intel Turbo Boost Mode Technology. Turbo Boost Mode allows processor cores to run faster than marked frequency in specific conditions. The default value is [Enabled].

CPU Thermal Throttling

You may select [Enabled] to enable CPU internal thermal control mechanism to keep the CPU from overheating.

No-Execute Memory Protection

No-Execution (NX) Memory Protection Technology is an enhancement to the IA-32 Intel Architecture. An IA-32 processor with “No Execute (NX) Memory Protection” can prevent data pages from being used by malicious software to execute codes. This option will be hidden if the current CPU does not support No-Execute Memory Protection.

Intel Virtualization Technology

When this option is set to [Enabled], a VMM (Virtual Machine Architecture) can utilize the additional hardware capabilities provided by Vanderpool Technology. This option will be hidden if the installed CPU does not support Intel Virtualization Technology.

Hardware Prefetcher

Use this item to turn on/off the MLC streamer prefetcher.

Adjacent Cache Line Prefetch

Use this item to turn on/off prefetching of adjacent cache lines.

SW Guard Extensions (SGX)

Intel SGX is a set of new CPU instructions that can be used by applications to set aside private regions of code and data.

3.3.2 Chipset Configuration



Primary Graphics Adapter

This allows you to select [Onboard] or [PCI Express] as the boot graphic adapter priority. The default value is [PCI Express].

Top of Lower usable DRAM

Set the maximum value of TOLUD. Set this item to Dynamic to allow TOLUD to adjust automatically based on the largest MMIO length of the installed graphic controller.

VT-d

Use this to enable or disable Intel® VT-d technology (Intel® Virtualization Technology for Directed I/O). The default value of this feature is [Disabled].

PCIe1 Link Speed

Select the link speed for PCIe1.

Share Memory

Configure the size of memory that is allocated to the integrated graphics processor when the system boots up.

IGPU Multi-Monitor

Select disable to disable the integrated graphics when an external graphics card is installed. Select enable to keep the integrated graphics enabled at all times.

Onboard LAN1

This allows you to enable or disable the Onboard LAN1 feature.

Onboard LAN2

This allows you to enable or disable the Onboard LAN2 feature.

Onboard HD Audio

Select [Auto], [Enabled] or [Disabled] for the onboard HD Audio feature. If you select [Auto], the onboard HD Audio will be disabled when PCI Sound Card is plugged.

Front Panel

Select [HD] or [AC 97] for the onboard HD Audio Front Panel.

Deep Sleep

Mobile platforms support Deep S4/S5 in DC only and desktop platforms support Deep S4/S5 in AC only. The default value is [Disabled].

eDP Panel BackLight Brightness

The default value is [Level 5].

Primary IGFX Boot Display

Use this to select primary internal graphics boot display. The default value is [VBIOS Default].

3.3.3 Storage Configuration

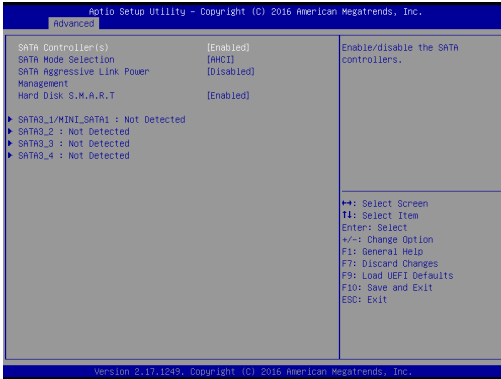

SATA Controller(s)

Use this item to enable or disable the SATA Controller feature.

SATA Mode Selection

Use this to select SATA mode. The default value is [AHCI Mode].



AHCI (Advanced Host Controller Interface) supports NCQ and other new features that will improve SATA disk performance but IDE mode does not have these advantages.

SATA Aggressive Link Power Management

Use this item to configure SATA Aggressive Link Power Management.

Hard Disk S.M.A.R.T.

Use this item to enable or disable the S.M.A.R.T. (Self-Monitoring, Analysis, and Reporting Technology) feature. Configuration options: [Disabled] and [Enabled].

3.3.4 AMT Technology



Intel AMT

Use this to enable or disable Intel(R) Active Management Technology BIOS Extension. The default is [Enabled].

BIOS Hotkey Pressed

Use this to enable or disable BIOS hotkey press. The default is [Disabled].

MEBx Selection Screen

Use this to enable or disable MEBx Selection Screen. The default is [Disabled].

Hide Un-Configure ME Confirmation

Hide Un-Configure ME without password confirmation prompt. The default is [Disabled].

MEBx Debug Message Output

Use this to enable or disable MEBx Debug Message Output. The default is [Disabled].

Un-Configure ME

Un-Configure ME without password. The default is [Disabled].

Amt Wait Timer

Set timer to wait before sending ASF_GET_BOOT_OPTIONS.

ASF

Use this to enable or disable Alert Specification Format. The default is [Enabled].

Activate Remote Assistance Process

Trigger CIRA boot. The default is [Disabled].

USB Configure

Use this to enable or disable USB Configure function. The default is [Enabled].

PET Progress

User can enable or disable PET Events progress to receive PET events or not. The default is [Enabled].

3.3.5 Super IO Configuration

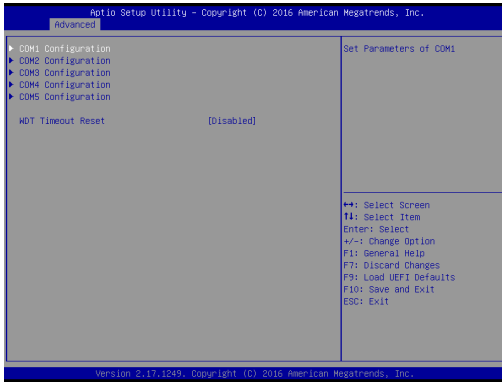

COM1 Configuration

Use this to set parameters of COM1. Select COM1 port type: [RS232], [RS422] or [RS485].

COM2 Configuration

Use this to set parameters of COM2. Select COM2 port type: [RS232], [RS422] or [RS485].

COM3 Configuration

Use this to set parameters of COM3.

COM4 Configuration

Use this to set parameters of COM4.

COM5 Configuration

Use this to set parameters of COM5.

Watchdog Configuration

Use this to set the Watch Dog Timer.

3.3.6 ACPI Configuration

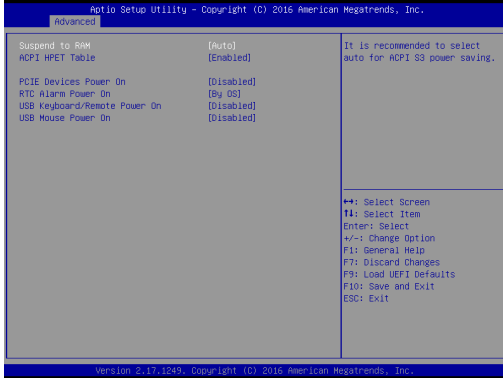

Suspend to RAM

Use this item to select whether to auto-detect or disable the Suspend-to-RAM feature. Select [Auto] will enable this feature if the OS supports it.

ACPI HPET Table

Use this item to enable or disable ACPI HPET Table. The default value is [Enabled]. Please set this option to [Enabled] if you plan to use this motherboard to submit Windows® certification.

PCIE Devices Power On

Use this item to enable or disable PCIE devices to turn on the system from the power-soft-off mode.

RTC Alarm Power On

Use this item to enable or disable RTC (Real Time Clock) to power on the system.

USB Keyboard/Remote Power On

Use this item to enable or disable USB Keyboard/Remote to power on the system.

USB Mouse Power On

Use this item to enable or disable USB Mouse to power on the system.

3.3.7 USB Configuration



Legacy USB Support

Use this option to select legacy support for USB devices. There are four configuration options: [Enabled], [Auto] and [UEFI Setup Only]. The default value is [Enabled]. Please refer to below descriptions for the details of these four options:

[Enabled] - Enables support for legacy USB.

[Auto] - Enables legacy support if USB devices are connected.

[UEFI Setup Only] - USB devices are allowed to use only under UEFI setup and Windows / Linux OS.

PS/2 Simulator

Enable this item for the complete USB keyboard legacy support for non-USB aware operating system.

3.3.8 Trusted Computing

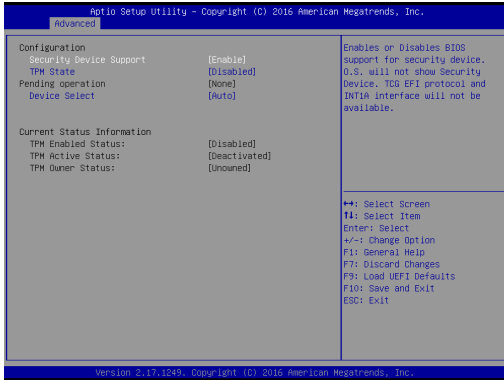

Security Device Support

Enable or disable BIOS support for security device.

3.4 Hardware Health Event Monitoring Screen

In this section, it allows you to monitor the status of the hardware on your system, including the parameters of the CPU temperature, motherboard temperature, CPU fan speed, chassis fan speed, and the critical voltage.

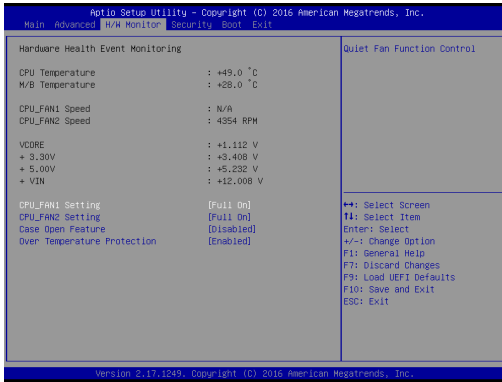

CPU_FAN1 Setting

This allows you to set CPU fan 1's speed. Configuration options: [Full On] and [Automatic Mode]. The default value is [Full On].

CPU_FAN2 Setting

This allows you to set CPU fan 2's speed. Configuration options: [Full On] and [Automatic Mode]. The default value is [Full On].

Case Open Feature

This allows you to enable or disable case open detection feature. The default is value [Disabled].

Clear Status

This option appears only when the case open has been detected. Use this option to keep or clear the record of previous chassis intrusion status.

Over Temperature Protection

Use this to enable or disable Over Temperature Protection. The default value is [Enabled].

3.5 Security Screen

In this section, you may set, change or clear the supervisor/user password for the system.

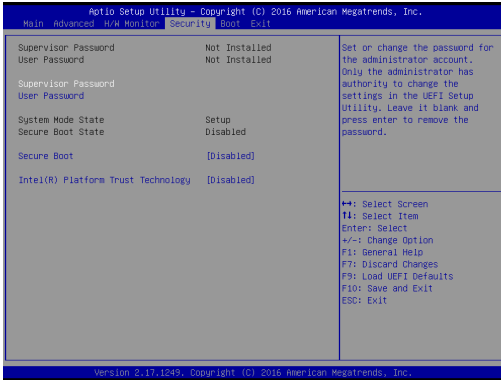

Supervisor Password

Set or change the password for the administrator account. Only the administrator has authority to change the settings in the UEFI Setup Utility. Leave it blank and press enter to remove the password.

User Password

Set or change the password for the user account. Users are unable to change the settings in the UEFI Setup Utility. Leave it blank and press enter to remove the password.

Secure Boot

Enable to support Windows 8.1 / 8 Secure Boot.

Intel(R) Platform Trust Technology

Enable/disable Intel PTT in ME. Disable this option to use discrete TPM Module.

3.6 Boot Screen

In this section, it will display the available devices on your system for you to configure the boot settings and the boot priority.

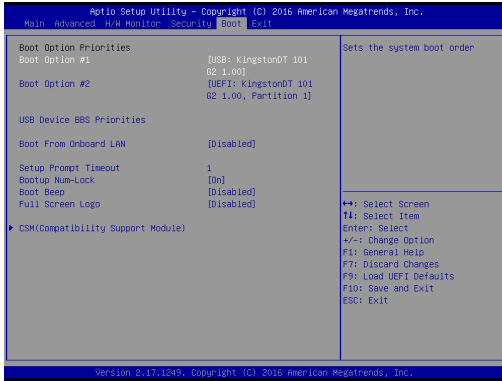

Boot From Onboard LAN

Use this item to enable or disable the Boot From Onboard LAN feature.

Setup Prompt Timeout

This shows the number of seconds to wait for setup activation key. 65535(0XFFFF) means indefinite waiting.

Bootup Num-Lock

If this item is set to [On], it will automatically activate the Numeric Lock function after boot-up.

Boot Beep

Select whether the Boot Beep should be turned on or off when the system boots up. Please note that a buzzer is needed.

Full Screen Logo

Use this item to enable or disable OEM Logo. The default value is [Enabled].

CSM (Compatibility Support Module)

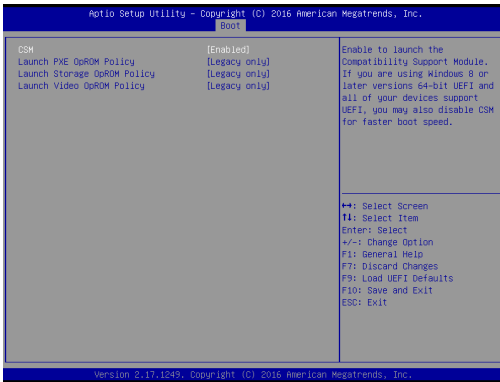

CSM

Enable to launch the Compatibility Support Module. Please do not disable unless you're running a WHCK test. If you are using Windows® 8.1 / 8 64-bit and all of your devices support UEFI, you may also disable CSM for faster boot speed.

Launch PXE OpROM Policy

Select UEFI only to run those that support UEFI option ROM only. Select Legacy only to run those that support legacy option ROM only. Do not launch?

Launch Storage OpROM Policy

Select UEFI only to run those that support UEFI option ROM only. Select Legacy only to run those that support legacy option ROM only. Do not launch?

Launch Video OpROM Policy

Select UEFI only to run those that support UEFI option ROM only. Select Legacy only to run those that support legacy option ROM only. Do not launch?

3.7 Exit Screen

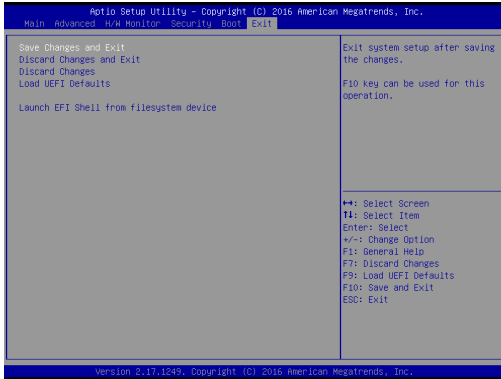

Save Changes and Exit

When you select this option, it will pop-out the following message, "Save configuration changes and exit setup?" Select [OK] to save the changes and exit the UEFI SETUP UTILITY.

Discard Changes and Exit

When you select this option, it will pop-out the following message, "Discard changes and exit setup?" Select [OK] to exit the UEFI SETUP UTILITY without saving any changes.

Discard Changes

When you select this option, it will pop-out the following message, "Discard changes?" Select [OK] to discard all changes.

Load UEFI Defaults

Load UEFI default values for all the setup questions. F9 key can be used for this operation.

Launch EFI Shell from filesystem device

Attempts to Launch EFI Shell application (Shell64.efi) from one of the available filesystem devices.

Chapter 4: Software Support

4.1 Install Operating System

This motherboard supports various Microsoft® Windows® operating systems: 10 / 10 64-bit / 8.1 / 8.1 64-bit / 8 / 8 64-bit / 7 / 7 64-bit. Because motherboard settings and hardware options vary, use the setup procedures in this chapter for general reference only. Refer your OS documentation for more information.

4.2 Support CD Information

The Support CD that came with the motherboard contains necessary drivers and useful utilities that enhance the motherboard's features.

4.2.1 Running The Support CD

To begin using the support CD, insert the CD into your CD-ROM drive. The CD automatically displays the Main Menu if "AUTORUN" is enabled in your computer. If the Main Menu did not appear automatically, locate and double click on the file "ASRSETUP.EXE" from the BIN folder in the Support CD to display the menus.

4.2.2 Drivers Menu

The Drivers Menu shows the available device's drivers if the system detects installed devices. Please install the necessary drivers to activate the devices.

4.2.3 Utilities Menu

The Utilities Menu shows the application software that the motherboard supports. Click on a specific item then follow the installation wizard to install it.

4.2.4 Contact Information

If you need to contact ASRock or want to know more about ASRock, you're welcome to visit ASRock's website at <http://www.asrock.com>; or you may contact your dealer for further information.